



2SA1015

PNP SILICON TRANSISTOR

LOW FREQUENCY PNP AMPLIFIER TRANSISTOR

FEATURES

- * Collector-Emitter Voltage: $BV_{CE0} = -50V$
- * Collector Current up to 150mA
- * High h_{FE} Linearity
- * Complement to UTC 2SC1815

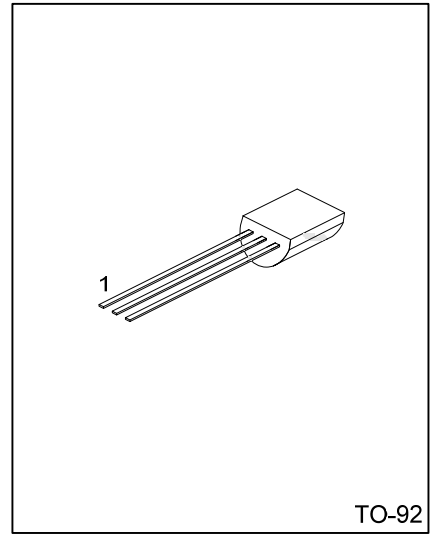

Lead-free: 2SA1015L
 Halogen-free: 2SA1015G

ORDERING INFORMATION

Ordering Number			Package	Pin Assignment			Packing
Normal	Lead Free Plating	Halogen Free		1	2	3	
2SA1015-x-T92-B	2SA1015L-x-T92-B	2SA1015G-x-T92-B	TO-92	E	C	B	Tape Box
2SA1015-x-T92-K	2SA1015L-x-T92-K	2SA1015G-x-T92-K	TO-92	E	C	B	Bulk

<p>2SA1015L-x-T92-B</p> <p>(1)Packing Type (2)Package Type (3)Rank (4)Lead Plating</p>	<p>(1) B: Tape Box, K: Bulk (2) T92: TO-92 (3) x: refer to Classification of h_{FE} (4) G: Halogen Free, L: Lead Free Plating, Blank: Pb/Sn</p>
-------------------------------------------------------------------------------------------------------------------------	-----------------------------------------------------------------------------------------------------------------------------------------------------------------------------------------------

■ ABSOLUTE MAXIMUM RATING (Ta=25°C, unless otherwise specified)

PARAMETER	SYMBOL	RATINGS	UNIT
Collector-Base Voltage	V _{CBO}	-50	V
Collector-Emitter Voltage	V _{CEO}	-50	V
Emitter-Base Voltage	V _{EBO}	-5	V
Collector Current	I _C	-150	mA
Base Current	I _B	-50	mA
Collector Dissipation	P _C	400	mW
Junction Temperature	T _J	125	°C
Storage Temperature	T _{STG}	-55 ~ +125	°C

Note: Absolute maximum ratings are those values beyond which the device could be permanently damaged.

Absolute maximum ratings are stress ratings only and functional device operation is not implied.

■ ELECTRICAL CHARACTERISTICS (Ta=25°C, unless otherwise specified)

PARAMETER	SYMBOL	TEST CONDITIONS	MIN	TYP	MAX	UNIT
Collector-Base Breakdown Voltage	BV _{CBO}	I _C =-100μA, I _E =0	-50			V
Collector-Emitter Breakdown Voltage	BV _{CEO}	I _C =-10mA, I _B =0	-50			V
Emitter-Base Breakdown Voltage	BV _{EBO}	I _E =-10μA, I _C =0	-5			V
Collector Cut-off Current	I _{CBO}	V _{CB} =-50V, I _E =0			-100	nA
Emitter Cut-off Current	I _{EBO}	V _{EB} =-5V, I _C =0			-100	nA
DC Current Gain	h _{FE1}	V _{CE} =-6V, I _C =-2mA	120		700	
	h _{FE2}	V _{CE} =-6V, I _C =-150mA	25			
Collector-Emitter Saturation Voltage	V _{CE(SAT)}	I _C =-100mA, I _B =-10mA		-0.1	-0.3	V
Base-Emitter Saturation Voltage	V _{BE(SAT)}	I _C =-100mA, I _B =-10mA			-1.1	V
Output Capacitance	C _{OB}	V _{CB} =-10V, I _E =0, f=1MHz		4.0	7.0	pF
Current Gain Bandwidth Product	f _T	V _{CE} =-10V, I _C =-1mA	80			MHz
Noise Figure	NF	V _{CE} =-6V, I _C =-0.1mA, R _G =1kΩ, f=100Hz		0.5	6	dB

■ CLASSIFICATION OF h_{FE1}

RANK	Y	GR	BL
RANGE	120-240	200-400	350-700

■ TYPICAL CHARACTERISTICS

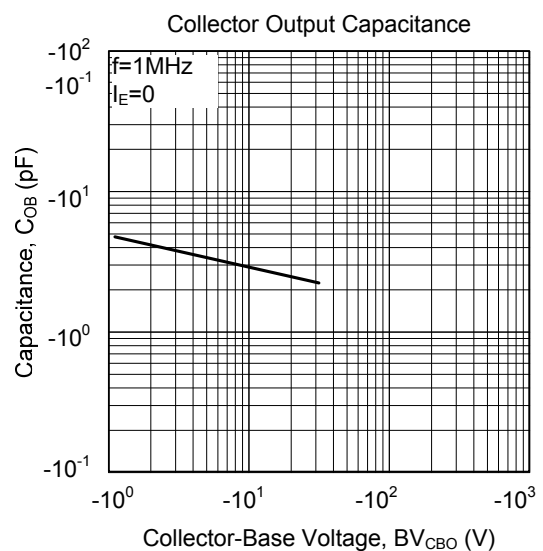
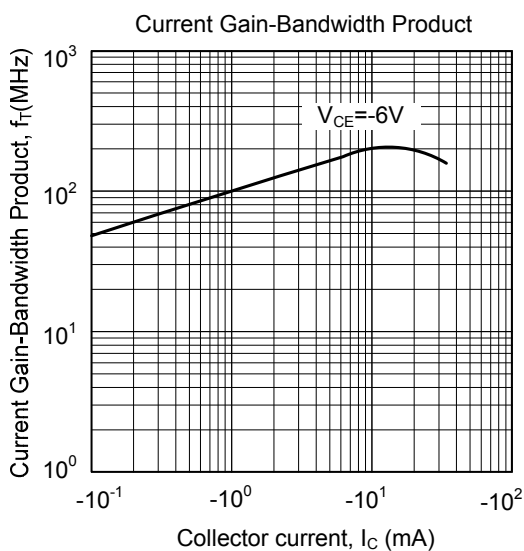
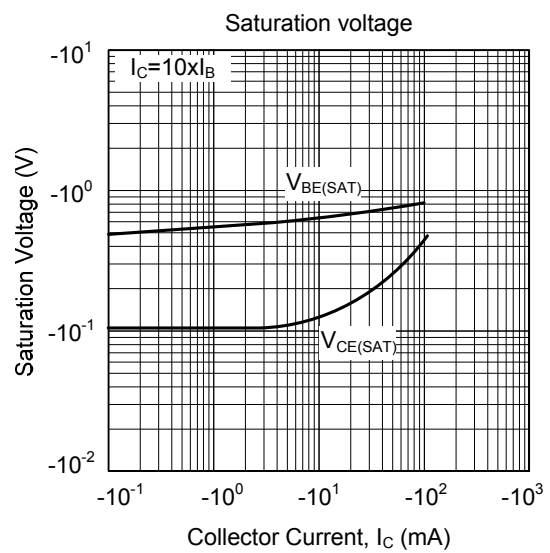
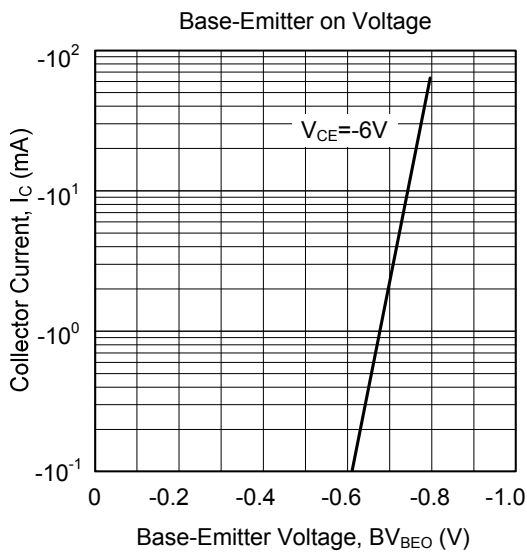
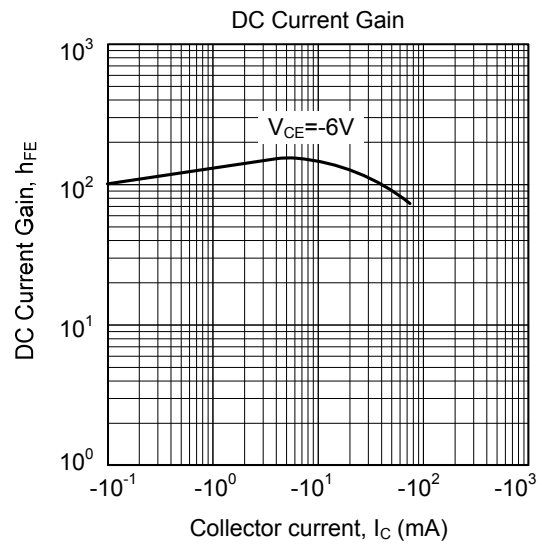
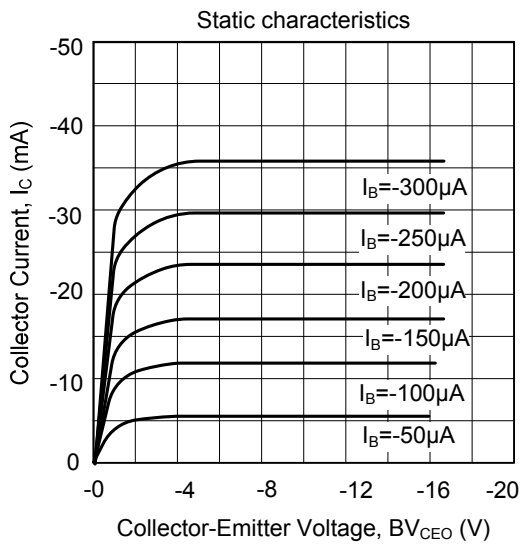

UTC assumes no responsibility for equipment failures that result from using products at values that exceed, even momentarily, rated values (such as maximum ratings, operating condition ranges, or other parameters) listed in products specifications of any and all UTC products described or contained herein. UTC products are not designed for use in life support appliances, devices or systems where malfunction of these products can be reasonably expected to result in personal injury. Reproduction in whole or in part is prohibited without the prior written consent of the copyright owner. The information presented in this document does not form part of any quotation or contract, is believed to be accurate and reliable and may be changed without notice.