

GE Healthcare

LOGIQ Book XP/XP PRO/XP Vet Service Manual

Basic Service Manual



Part Number: 2406070-100
Revision: 17

Important Precautions

WARNING
(EN)

THIS SERVICE MANUAL IS AVAILABLE IN ENGLISH ONLY.

- IF A CUSTOMER'S SERVICE PROVIDER REQUIRES A LANGUAGE OTHER THAN ENGLISH, IT IS THE CUSTOMER'S RESPONSIBILITY TO PROVIDE TRANSLATION SERVICES.
- DO NOT ATTEMPT TO SERVICE THE EQUIPMENT UNLESS THIS SERVICE MANUAL HAS BEEN CONSULTED AND IS UNDERSTOOD.
- FAILURE TO HEED THIS WARNING MAY RESULT IN INJURY TO THE SERVICE PROVIDER, OPERATOR OR PATIENT FROM ELECTRIC SHOCK, MECHANICAL OR OTHER HAZARDS.

AVERTISSEMENT
(FR)

CE MANUEL DE MAINTENANCE N'EST DISPONIBLE QU'EN ANGLAIS.

- SI LE TECHNICIEN DU CLIENT A BESOIN DE CE MANUEL DANS UNE AUTRE LANGUE QUE L'ANGLAIS, C'EST AU CLIENT QU'IL INCOMBE DE LE FAIRE TRADUIRE.
- NE PAS TENTER D'INTERVENTION SUR LES ÉQUIPEMENTS TANT QUE LE MANUEL SERVICE N'A PAS ÉTÉ CONSULTÉ ET COMPRIS.
- LE NON-RESPECT DE CET AVERTISSEMENT PEUT ENTRAÎNER CHEZ LE TECHNICIEN, L'OPÉRATEUR OU LE PATIENT DES BLESSURES DUES À DES DANGERS ÉLECTRIQUES, MÉCANIQUES OU AUTRES.

WARNUNG
(DE)

DIESES KUNDENDIENST-HANDBUCH EXISTIERT NUR IN ENGLISCHER SPRACHE.

- FALLS EIN FREMDER KUNDENDIENST EINE ANDERE SPRACHE BENÖTIGT, IST ES AUFGABE DES KUNDEN FÜR EINE ENTSPRECHENDE ÜBERSETZUNG ZU SORGEN.
- VERSUCHEN SIE NICHT, DAS GERÄT ZU REPARIEREN, BEVOR DIESES KUNDENDIENST-HANDBUCH NICHT ZU RATE GEZOGEN UND VERSTANDEN WURDE.
- WIRD DIESE WARNUNG NICHT BEACHTET, SO KANN ES ZU VERLETZUNGEN DES KUNDENDIENSTTECHNIKERS, DES BEDIENERS ODER DES PATIENTEN DURCH ELEKTRISCHE SCHLÄGE, MECHANISCHE ODER SONSTIGE GEFAHREN KOMMEN.

ESTE MANUAL DE SERVICIO SÓLO EXISTE EN INGLÉS.

**AVISO
(ES)**

- SI ALGÚN PROVEEDOR DE SERVICIOS AJENO A GEHC SOLICITA UN IDIOMA QUE NO SEA EL INGLÉS, ES RESPONSABILIDAD DEL CLIENTE OFRECER UN SERVICIO DE TRADUCCIÓN.
- NO SE DEBERÁ DAR SERVICIO TÉCNICO AL EQUIPO, SIN HABER CONSULTADO Y COMPRENDIDO ESTE MANUAL DE SERVICIO.
- LA NO OBSERVANCIA DEL PRESENTE AVISO PUEDE DAR LUGAR A QUE EL PROVEEDOR DE SERVICIOS, EL OPERADOR O EL PACIENTE SUFRAN LESIONES PROVOCADAS POR CAUSAS ELÉCTRICAS, MECÁNICAS O DE OTRA NATURALEZA.

ESTE MANUAL DE ASSISTÊNCIA TÉCNICA SÓ SE ENCONTRA DISPONÍVEL EM INGLÊS.

**ATENÇÃO
(PT-Br)**

- SE QUALQUER OUTRO SERVIÇO DE ASSISTÊNCIA TÉCNICA, QUE NÃO A GEHC, SOLICITAR ESTES MANUAIS NOUTRO IDIOMA, É DA RESPONSABILIDADE DO CLIENTE FORNECER OS SERVIÇOS DE TRADUÇÃO.
- NÃO TENHA TENTADO REPARAR O EQUIPAMENTO SEM TER CONSULTADO E COMPREENDIDO ESTE MANUAL DE ASSISTÊNCIA TÉCNICA.
- O NÃO CUMPRIMENTO DESTA AVISO PODE POR EM PERIGO A SEGURANÇA DO TÉCNICO, OPERADOR OU PACIENTE DEVIDO A CHOQUES ELÉTRICOS, MECÂNICOS OU OUTROS.

ESTE MANUAL DE ASSISTÊNCIA ESTÁ DISPONÍVEL APENAS EM INGLÊS.

**AVISO
(PT-pt)**

- SE QUALQUER OUTRO SERVIÇO DE ASSISTÊNCIA TÉCNICA, QUE NÃO A GEHC, SOLICITAR ESTES MANUAIS NOUTRO IDIOMA, É DA RESPONSABILIDADE DO CLIENTE FORNECER OS SERVIÇOS DE TRADUÇÃO.
- NÃO TENHA EFECTUADO REPARAÇÕES NO EQUIPAMENTO SEM TER CONSULTADO E COMPREENDIDO PREVIAMENTE ESTE MANUAL.
- A INOBSERVÂNCIA DESTA AVISO PODE RESULTAR EM FERIMENTOS NO TÉCNICO DE ASSISTÊNCIA, OPERADOR OU PACIENTE EM CONSEQUÊNCIA DE CHOQUE ELÉTRICO, PERIGOS DE ORIGEM MECÂNICA, BEM COMO DE OUTROS TIPOS.

IL PRESENTE MANUALE DI MANUTENZIONE È DISPONIBILE SOLTANTO IN INGLESE.

**AVVERTENZA
(IT)**

- SE UN ADDETTO ALLA MANUTENZIONE ESTERNO ALLA GEHC RICHIEDE IL MANUALE IN UNA LINGUA DIVERSA, IL CLIENTE È TENUTO A PROVVEDERE DIRETTAMENTE ALLA TRADUZIONE.
- SI PROCEDA ALLA MANUTENZIONE DELL'APPARECCHIATURA SOLO DOPO AVER CONSULTATO IL PRESENTE MANUALE ED AVERNE COMPRESO IL CONTENUTO.
- NON TENERE CONTO DELLA PRESENTE AVVERTENZA POTREBBE FAR COMPIERE OPERAZIONI DA CUI DERIVINO LESIONI ALL'ADDETTO ALLA MANUTENZIONE, ALL'UTILIZZATORE ED AL PAZIENTE PER FOLGORAZIONE ELETTRICA, PER URTI MECCANICI OD ALTRI RISCHI.

HOIATUS
(ET)

KÄESOLEV TEENINDUSJUHEND ON SAADAVAL AINULT INGLISE KEELES.

- KUI KLIENDITEENINDUSE OSUTAJA NÕUAB JUHENDIT INGLISE KEELEST ERINEVAS KEELES, VASTUTAB KLIENT TÕLKETEENUSE OSUTAMISE EEST.
- ÄRGE ÜRITAGE SEADMEID TEENINDADA ENNE EELNEVALT KÄESOLEVA TEENINDUSJUHENDIGA TUTVUMIST JA SELLEST ARU SAAMIST.
- KÄESOLEVA HOIATUSE EIRAMINE VÕIB PÕHJUSTADA TEENUSEOSUTAJA, OPERAATORI VÕI PATSIENDI VIGASTAMIST ELEKTRILÖÖGI, MEHAANILISE VÕI MUU OHU TAGAJÄRJEL.

VAROITUS
(FI)

TÄMÄ HUOLTO-OHJE ON SAATAVILLA VAIN ENGLANNIKSI.

- JOS ASIAKKAAN PALVELUNTARJOAJA VAATII MUUTA KUIN ENGLANNINKIELISTÄ MATERIAALIA, TARVITTAVAN KÄÄNNÖKSEN HANKKIMINEN ON ASIAKKAAN VASTUULLA.
- ÄLÄ YRITÄ KORJATA LAITTEISTOA ENNEN KUIN OLET VARMASTI LUKENUT JA YMMÄRTÄNYT TÄMÄN HUOLTO-OHJEEN.
- MIKÄLI TÄTÄ VAROITUSTA EI NOUDATETA, SEURAUKSENA VOI OLLA PALVELUNTARJOAJAN, LAITTEISTON KÄYTTÄJÄN TAI POTILAAN VAHINGOITTUMINEN SÄHKÖISKUN, MEKAANISEN VIAN TAI MUUN VAARATILANTEEN VUOKSI.

ΠΡΟΕΙΔΟΠΟΙΗΣΗ
(EL)

ΤΟ ΠΑΡΟΝ ΕΓΧΕΙΡΙΔΙΟ ΣΕΡΒΙΣ ΔΙΑΤΙΘΕΤΑΙ ΣΤΑ ΑΓΓΛΙΚΑ ΜΟΝΟ.

- ΕΑΝ ΤΟ ΑΤΟΜΟ ΠΑΡΟΧΗΣ ΣΕΡΒΙΣ ΕΝΟΣ ΠΕΛΑΤΗ ΑΠΑΙΤΕΙ ΤΟ ΠΑΡΟΝ ΕΓΧΕΙΡΙΔΙΟ ΣΕ ΓΛΩΣΣΑ ΕΚΤΟΣ ΤΩΝ ΑΓΓΛΙΚΩΝ, ΑΠΟΤΕΛΕΙ ΕΥΘΥΝΗ ΤΟΥ ΠΕΛΑΤΗ ΝΑ ΠΑΡΕΧΕΙ ΥΠΗΡΕΣΙΕΣ ΜΕΤΑΦΡΑΣΗΣ.
- ΜΗΝ ΕΠΙΧΕΙΡΗΣΕΤΕ ΤΗΝ ΕΚΤΕΛΕΣΗ ΕΡΓΑΣΙΩΝ ΣΕΡΒΙΣ ΣΤΟΝ ΕΞΟΠΛΙΣΜΟ ΕΚΤΟΣ ΕΑΝ ΕΧΕΤΕ ΣΥΜΒΟΥΛΕΥΤΕΙ ΚΑΙ ΕΧΕΤΕ ΚΑΤΑΝΟΗΣΕΙ ΤΟ ΠΑΡΟΝ ΕΓΧΕΙΡΙΔΙΟ ΣΕΡΒΙΣ.
- ΕΑΝ ΔΕ ΛΑΒΕΤΕ ΥΠΟΨΗ ΤΗΝ ΠΡΟΕΙΔΟΠΟΙΗΣΗ ΑΥΤΗ, ΕΝΔΕΧΕΤΑΙ ΝΑ ΠΡΟΚΛΗΘΕΙ ΤΡΑΥΜΑΤΙΣΜΟΣ ΣΤΟ ΑΤΟΜΟ ΠΑΡΟΧΗΣ ΣΕΡΒΙΣ, ΣΤΟ ΧΕΙΡΙΣΤΗ Ή ΣΤΟΝ ΑΣΘΕΝΗ ΑΠΟ ΗΛΕΚΤΡΟΠΛΗΞΙΑ, ΜΗΧΑΝΙΚΟΥΣ Ή ΑΛΛΟΥΣ ΚΙΝΔΥΝΟΥΣ.

FIGYELMEZTETÉS
(HU)

EZEN KARBANTARTÁSI KÉZIKÖNYV KIZÁRÓLAG ANGOL NYELVEN ÉRHEŐ EL.

- HA A VEVŐ SZOLGÁLTATÓJA ANGOLTÓL ELTÉRŐ NYELVRE TART IGÉNYT, AKKOR A VEVŐ FELELŐSSÉGE A FORDÍTÁS ELKÉSZÍTTETÉSE.
- NE PRÓBÁLJA ELKEZDENI HASZNÁLNI A BERENDEZÉST, AMÍG A KARBANTARTÁSI KÉZIKÖNYVBEN LEÍRTAKAT NEM ÉRTELMEZTÉK.
- EZEN FIGYELMEZTETÉS FIGYELMEN KÍVÜL HAGYÁSA A SZOLGÁLTATÓ, MŰKÖDTETŐ VAGY A BETEG ÁRAMÚTÉS, MECHANIKAI VAGY EGYÉB VESZÉLYHELYZET MIATTI SÉRÜLÉSÉT EREDMÉNYEZHETI.

ÞESSI ÞJÓNUSTUHANDBÓK ER EINGÖNGU FÁANLEG Á ENSKU.

- EF ÞJÓNUSTUAÐILI VIÐSKIPTAMANNS ÞARFNAST ANNARS TUNGUMÁLS EN ENSKU, ER ÞAÐ Á ÁBYRGÐ VIÐSKIPTAMANNS AÐ ÚTVEGA ÞÝÐINGU.
- REYNIÐ EKKI AÐ ÞJÓNUSTA TÆKIÐ NEMA EFTIR AÐ HAFA SKOÐAÐ OG SKILIÐ ÞESSA ÞJÓNUSTUHANDBÓK.
- EF EKKI ER FARIÐ AÐ ÞESSARI VIÐVÖRUN GETUR ÞAÐ VALDIÐ MEIÐSLUM ÞJÓNUSTUVEITANDA, STJÓRNANDA EÐA SJÚKLINGS VEGNA RAFLOSTS, VÉLRÆNNAR EÐA ANNARRAR HÆTTU.

**VIÐVÖRUN
(IS)**

TENTO SERVISNÍ NÁVOD EXISTUJE POUZE V ANGLICKÉM JAZYCE.

- V PŘÍPADĚ, ŽE POSKYTOVATEL SLUŽEB ZÁKAZNÍKŮM POTŘEBUJE NÁVOD V JINÉM JAZYCE, JE ZAJIŠTĚNÍ PŘEKLADU DO ODPOVÍDAJÍCÍHO JAZYKA ÚKOLEM ZÁKAZNÍKA.
- NEPROVÁDĚJTE ÚDRŽBU TOHOTO ZAŘÍZENÍ, ANIŽ BYSTE SI PŘEČETLI TENTO SERVISNÍ NÁVOD A POCHOPILI JEHO OBSAH.
- V PŘÍPADĚ NEDODRŽOVÁNÍ TÉTO VÝSTRAHY MŮŽE DOJÍT ÚRAZU ELEKTRICKÁM PROUDEM PRACOVNÍKA POSKYTOVATELE SLUŽEB, OBSLUŽNÉHO PERSONÁLU NEBO PACIENTŮ V LIVEM ELEKTRICKÉHO Proudu, RESPEKTIVE V LIVEM K RIZIKU MECHANICKÉHO POŠKOZENÍ NEBO JINÉMU RIZIKU.

**VÝSTRAHA
(CS)**

DENNE SERVICEMANUAL FINDES KUN PÅ ENGELSK.

- HVIS EN KUNDES TEKNIKER HAR BRUG FOR ET ANDET SPROG END ENGELSK, ER DET KUNDENS ANSVAR AT SØRGE FOR OVERSÆTTELSE.
- FORSØG IKKE AT SERVICERE Udstyret medmindre denne servicemanual er blevet læst og forstået.
- MANGLENDE OVERHOLDELSE AF DENNE ADVARSEL KAN MEDFØRE SKADE PÅ GRUND AF ELEKTRISK, MEKANISK ELLER ANDEN FARE FOR TEKNIKEREN, OPERATØREN ELLER PATIENTEN.

**ADVARSEL
(DA)**

DEZE ONDERHOUDSHANDLEIDING IS ENKEL IN HET ENGELS VERKRIJGBAAR.

- ALS HET ONDERHOUDSPERSONEEL EEN ANDERE TAAL VEREIST, DAN IS DE KLANT VERANTWOORDELIJK VOOR DE VERTALING ERVAN.
- PROBEER DE APPARATUUR NIET TE ONDERHOUDEN VOORDAT DEZE ONDERHOUDSHANDLEIDING WERD GERAADPLEEGD EN BEGREPEN IS.
- INDIEN DEZE WAARSCHUWING NIET WORDT OPGEVOLGD, ZOU HET ONDERHOUDSPERSONEEL, DE OPERATOR OF EEN PATIËNT GEWOND KUNNEN RAKEN ALS GEVOLG VAN EEN ELEKTRISCHE SCHOK, MECHANISCHE OF ANDERE GEVAREN.

**WAARSCHUWING
(NL)**

**BRĪDINĀJUMS
(LV)**

ŠĪ APKALPES ROKASGRĀMATA IR PIEEJAMA TIKAI ANĢĻU VALODĀ.

- **JA KLIENTA APKALPES SNIEDZĒJAM NEPIECIEŠAMA INFORMĀCIJA CITĀ VALODĀ, NEVIS ANĢĻU, KLIENTA PIENĀKUMS IR NODROŠINĀT TULKOŠANU.**
- **NEVEICIET APRĪKOJUMA APKALPI BEZ APKALPES ROKASGRĀMATAS IZLASĪŠANAS UN SAPRAŠANAS.**
- **ŠĪ BRĪDINĀJUMA NEIEVĒROŠANA VAR RADĪT ELEKTRISKĀS STRĀVAS TRIECIENA, MEHĀNISKU VAI CITU RISKU IZRAISĪTU TRAUMU APKALPES SNIEDZĒJAM, OPERATORAM VAI PACIENTAM.**

**ĮSPĖJIMAS
(LT)**

ŠIS EKSPLOATAVIMO VADOVAS YRA IŠLEISTAS TIK ANĢĻU KALBA.

- **JEI KLIENTO PASLAUGŲ TEIKĒJUI REIKIA VADOVO KITA KALBA – NE ANĢĻU, VERTIMU PASIRŪPINTI TURI KLIENTAS.**
- **NEMĒGINKITE ATLIKTI ĮRANGOS TECHNINĒS PRIEŽIŪROS DARBŲ, NEBENT VADOVAUTUMĒTĒS ŠIUO EKSPLOATAVIMO VADOVU IR JĮ SUPRASTUMĒTE**
- **NEPAISANT ŠIO PERSPĖJIMO, PASLAUGŲ TEIKĒJAS, OPERATORIUS AR PACIENTAS GALI BŪTI SUŽEISTAS DĒĻ ELEKTROS SMŪGIO, MECHANINIŲ AR KITŲ PAVOJŲ.**

**ADVARSEL
(NO)**

DENNE SERVICEHÅNDBOKEN FINNES BARE PÅ ENGELSK.

- **HVIS KUNDENS SERVICELEVERANDØR TRENGER ET ANNET SPRÅK, ER DET KUNDENS ANSVAR Å SØRGE FOR OVERSETTELSE.**
- **IKKE FORSØK Å REPARERE UTSTYRET UTEN AT DENNE SERVICEHÅNDBOKEN ER LEST OG FORSTÅTT.**
- **MANGLENDE HENSYN TIL DENNE ADVARSELEN KAN FØRE TIL AT SERVICELEVERANDØREN, OPERATØREN ELLER PASIENTEN SKADES PÅ GRUNN AV ELEKTRISK STØT, MEKANISKE ELLER ANDRE FARER.**

**OSTRZEŻENIE
(PL)**

NINIEJSZY PODRĘCZNIK SERWISOWY DOSTĘPNY JEST JEDYNIEM W JĘZYKU ANGIELSKIM.

- **JEŚLI FIRMA ŚWIADCZĄCA KLIENTOWI USŁUGI SERWISOWE WYMAGA UDOSTĘPNIENIA PODRĘCZNIKA W JĘZYKU INNYM NIŻ ANGIELSKI, OBOWIĄZEK ZAPEWNIENIA STOSOWNEGO TŁUMACZENIA SPOCZYWA NA KLIENCIE.**
- **NIE PRÓBOWAĆ SERWISOWAĆ NINIEJSZEGO SPRZĘTU BEZ UPRZEDNIEGO ZAPOZNANIA SIĘ Z PODRĘCZNIKIEM SERWISOWYM.**
- **NIEZASTOSOWANIE SIĘ DO TEGO OSTRZEŻENIA MOŻE GROZIĆ OBRAŻENIAMI CIAŁA SERWISANTA, OPERATORA LUB PACJENTA W WYNIKU PORAŻENIA PRĄDEM, URAZU MECHANICZNEGO LUB INNEGO RODZAJU ZAGROŻEŃ.**

**ATENȚIE
(RO)**

ACEST MANUAL DE SERVICE ESTE DISPONIBIL NUMAI ÎN LIMBA ENGLEZĂ.

- **DACĂ UN FURNIZOR DE SERVICII PENTRU CLIENȚI NECESITĂ O ALTĂ LIMBĂ DECÂT CEA ENGLEZĂ, ESTE DE DATORIA CLIENTULUI SĂ FURNIZEZE O TRADUCERE.**
- **NU ÎNCERCAȚI SĂ REPARAȚI ECHIPAMENTUL DECÂT ULTERIOR CONSULTĂRII ȘI ÎNȚELEGERII ACESTUI MANUAL DE SERVICE.**
- **IGNORAREA ACESTUI AVERTISMENT AR PUTEA DUCE LA RĂNIREA DEPANATORULUI, OPERATORULUI SAU PACIENTULUI ÎN URMA PERICOLELOR DE ELECTROCUTARE, MECANICE SAU DE ALTĂ NATURĂ.**

**ОСТОРОЖНО!
(RU)**

ДАННОЕ РУКОВОДСТВО ПО ОБСЛУЖИВАНИЮ ПРЕДОСТАВЛЯЕТСЯ ТОЛЬКО НА АНГЛИЙСКОМ ЯЗЫКЕ.

- **ЕСЛИ СЕРВИСНОМУ ПЕРСОНАЛУ КЛИЕНТА НЕОБХОДИМО РУКОВОДСТВО НЕ НА АНГЛИЙСКОМ ЯЗЫКЕ, КЛИЕНТУ СЛЕДУЕТ САМОСТОЯТЕЛЬНО ОБЕСПЕЧИТЬ ПЕРЕВОД.**
- **ПЕРЕД ОБСЛУЖИВАНИЕМ ОБОРУДОВАНИЯ ОБЯЗАТЕЛЬНО ОБРАТИТЕСЬ К ДАННОМУ РУКОВОДСТВУ И ПОЙМИТЕ ИЗЛОЖЕННЫЕ В НЕМ СВЕДЕНИЯ.**
- **НЕСОБЛЮДЕНИЕ УКАЗАННЫХ ТРЕБОВАНИЙ МОЖЕТ ПРИВЕСТИ К ТОМУ, ЧТО СПЕЦИАЛИСТ ПО ТЕХОБСЛУЖИВАНИЮ, ОПЕРАТОР ИЛИ ПАЦИЕНТ ПОЛУЧАТ УДАР ЗЛЕКТРИЧЕСКИМ ТОКОМ, МЕХАНИЧЕСКУЮ ТРАВМУ ИЛИ ДРУГОЕ ПОВРЕЖДЕНИЕ.**

**ПРЕДУПРЕЖДЕНИЕ
(BG)**

ТОВА СЕРВИЗНО РЪКОВОДСТВО Е НАЛИЧНО САМО НА АНГЛИЙСКИ ЕЗИК.

- **АКО ДОСТАВЧИКЪТ НА СЕРВИЗНИ УСЛУГИ НА КЛИЕНТ СЕ НУЖДАЕ ОТ ЕЗИК, РАЗЛИЧЕН ОТ АНГЛИЙСКИ, ЗАДЪЛЖЕНИЕ НА КЛИЕНТА Е ДА ПРЕДОСТАВИ ПРЕВОДАЧЕСКА УСЛУГА.**
- **НЕ СЕ ОПИТВАЙТЕ ДА ИЗВЪРШВАТЕ СЕРВИЗНО ОБСЛУЖВАНЕ НА ТОВА ОБОРУДВАНЕ, ОСВЕН ВСЛУЧАЙ, ЧЕ СЕРВИЗНОТО РЪКОВОДСТВО Е ПРОЧЕТЕНО И СЕ РАЗБИРА.**
- **НЕСПАЗВАНЕТО НА ТОВА ПРЕДУПРЕЖДЕНИЕ МОЖЕ ДА ДОВЕДЕ ДО НАРАНЯВАНЕ НА ДОСТАВЧИКА НА СЕРВИЗНИ УСЛУГИ, НА ОПЕРАТОРА ИЛИ ПАЦИЕНТА ВСЛЕДСТВИЕНА ТОКОВ УДАР, МЕХАНИЧНИ ИЛИ ДРУГИ РИСКОВЕ.**

**UPOZORENJE
(SR)**

OVAJ PRIRUČNIK ZA SERVISIRANJE DOSTUPAN JE SAMO NA ENGLLESKOM JEZIKU.

- **AKO KLIJENTOV SERVISER ZAHTEVA JEZIK KOJI NIJE ENGLLESKI, ODGOVORNOST JE NA KLIJENTU DA PRUŽI USLUGE PREVOĐENJA.**
- **NEMOJTE POKUŠAVATI DA SERVISIRATE OPREMU AKO NISTE PROČITALI I RAZUMELI PRIRUČNIK ZA SERVISIRANJE.**
- **AKO NE POŠTUJETE OVO UPOZORENJE, MOŽE DOĆI DO POVREĐIVANJA SERVISERA, OPERATERA ILI PACIJENTA UZROKOVANOG ELEKTRIČNIM UDAROM, MEHANIČKIM I DRUGIM OPASNOSTIMA.**

TA SERVISNI PRIROČNIK JE NA VOLJO SAMO V ANGLEŠČINI.

**OPOZORILO
(SL)**

- ČE PONUDNIK SERVISNIH STORITEV ZA STRANKO POTREBUJE NAVODILA V DRUGEM JEZIKU, JE ZA PREVOD ODGOVORNA STRANKA SAMA.
- NE POSKUŠAJTE SERVISIRATI OPREME, NE DA BI PREJ PREBRALI IN RAZUMELI SERVISNI PRIROČNIK.
- ČE TEGA OPOZORILA NE UPOŠTEVATE, OBSTAJA NEVARNOST ELEKTRIČNEGA UDARA, MEHANSKIH ALI DRUGIH NEVARNOSTI IN POSLEDIČNIH POŠKODB PONUDNIKA SERVISNIH STORITEV, UPORABNIKA OPREME ALI PACIENTA.

OVAJ SERVISNI PRIRUČNIK DOSTUPAN JE SAMO NA ENGLESKOM JEZIKU.

**UPOZORENJE
(HR)**

- AKO KLIJENTOV SERVISER ZAHTIJEVA JEZIK KOJI NIJE ENGLESKI, ODGOVORNOST KLIJENTA JE PRUŽITI USLUGE PREVOĐENJA.
- NEMOJTE POKUŠAVATI SERVISIRATI OPREMU AKO NISTE PROČITALI I RAZUMJELI SERVISNI PRIRUČNIK.
- AKO NE POŠTUJETE OVO UPOZORENJE, MOŽE DOĆI DO OZLJEDE SERVISERA, OPERATERA ILI PACIJENTA PROUZROČENE STRUJNIM UDAROM, MEHANIČKIM I DRUGIM OPASNOSTIMA.

TÁTO SERVISNÁ PRÍRUČKA JE K DISPOZÍCII LEN V ANGLIČTINE.

**UPOZORNENIE
(SK)**

- AK ZÁKAZNÍKOV POSKYTOVATEĽ SLUŽIEB VYŽADUJE INÝ JAZYK AKO ANGLIČTINU, POSKYTNUTIE PREKLADATEĽSKÝCH SLUŽIEB JE ZODPOVEDNOSŤOU ZÁKAZNÍKA.
- NEPOKÚŠAJTE SA VYKONÁVAŤ SERVIS ZARIADENIA SKÔR, AKO SI NEPREČÍTATE SERVISNÚ PRÍRUČKU A NEPOROZUMIETE JEJ.
- ZANEDBANIE TOHTO UPOZORNENIA MÔŽE VYÚSTIŤ DO ZRANENIA POSKYTOVATEĽA SLUŽIEB, OBSLUHUJÚCEJ OSOBY ALEBO PACIENTA ELEKTRICKÝM PRÚDOM, PRÍPADNE DO MECHANICKÉHO ALEBO INÉHO NEBEZPEČENSTVA.

DEN HÄR SERVICEHANDBOKEN FINNS BARA TILLGÄNGLIG PÅ ENGELSKA.

**VARNING
(SV)**

- OM EN KUNDS SERVICETEKNIKER HAR BEHOV AV ETT ANNAT SPRÅK ÄN ENGELSKA ANSVARAR KUNDEN FÖR ATT TILLHANDAHÅLLA ÖVERSÄTTNINGSTJÄNSTER.
- FÖRSÖK INTE UTFÖRA SERVICE PÅ UTRUSTNINGEN OM DU INTE HAR LÄST OCH FÖRSTÅR DEN HÄR SERVICEHANDBOKEN.
- OM DU INTE TAR HÄNSYN TILL DEN HÄR VARNINGEN KAN DET RESULTERA I SKADOR PÅ SERVICETEKNIKERN, OPERATÖREN ELLER PATIENTEN TILL FÖLJD AV ELEKTRISKA STÖTAR, MEKANISKA FAROR ELLER ANDRA FAROR.

DİKKAT
(TR)

BU SERVİS KILAVUZU YALNIZCA İNGİLİZCE OLARAK SAĞLANMIŞTIR.

- EĞER MÜŞTERİ TEKNİSYENİ KILAVUZUN İNGİLİZCE DIŞINDAKİ BİR DİLDE OLMASINI İSTERSE, KILAVUZU TERCÜME ETTİRMEK MÜŞTERİNİN SORUMLULUĞUNDADIR.
- SERVİS KILAVUZUNU OKUYUP ANLAMADAN EKİPMANLARA MÜDAHALE ETMEYİNİZ.
- BU UYARININ GÖZ ARDI EDİLMESİ, ELEKTRİK ÇARPMASI YA DA MEKANİK VEYA DİĞER TÜRDE KAZALAR SONUCUNDA TEKNİSYENİN, OPERATÖRÜN YA DA HASTANIN YARALANMASINA YOL AÇABİLİR.

警告
(JA)

このサービスマニュアルには英語版しかありません。

GEHC 以外でサービスを担当される業者が英語以外の言語を要求される場合、翻訳作業はその業者の責任で行うものとさせていただきます。

このサービスマニュアルを熟読し理解せずに、装置のサービスを行わないで下さい。

この警告に従わない場合、サービスを担当される方、操作員あるいは患者さんが、感電や機械的又はその他の危険により負傷する可能性があります。

本服務手冊僅提供英文版。

- 如顧客之服務提供者需要英文版以外之語言，顧客需自行負擔其翻譯服務之責任。
- 在查閱並了解本服務手冊之內容前，請勿試圖維修本設備。
- 未確實遵守本警告，可能導致服務提供者、操作者或病患遭受電擊、機械危險或其他傷害。

警告
(繁體中文)
Traditional
Chinese

注意:
(ZH-CN)

本维修手册仅存有英文本。
非 GEHC 公司的维修员要求非英文本的维修手册时，
客户需自行负责翻译。
未详细阅读和完全了解本手册之前，不得进行维修。
忽略本注意事项会对维修员，操作员或病人造成触电，机械伤害或其他伤害。

경고
(KO)

- 본 서비스 지침서는 영어로만 이용하실 수 있습니다.
- 고객의 서비스 제공자가 영어이외 언어를 요구할 경우, 번역 서비스 지침서를 제공하는 것은 고객의 책임입니다.
- 본 서비스 지침서를 지참했고 이해하지 않는 한은 해당 장비를 수리를 시도하지 마십시오.
- 이 경우에 유해하지 않은 전기쇼크, 기계상의 혹은 다른 위험으로부터 서비스 제공자, 운영자 혹은 환자에게 위험을 가할 수 있습니다.

DAMAGE IN TRANSPORTATION

All packages should be closely examined at time of delivery. If damage is apparent write "Damage In Shipment" on ALL copies of the freight or express bill BEFORE delivery is accepted or "signed for" by a GE representative or hospital receiving agent. Whether noted or concealed, damage MUST be reported to the carrier immediately upon discovery, or in any event, within 14 days after receipt, and the contents and containers held for inspection by the carrier. A transportation company will not pay a claim for damage if an inspection is not requested within this 14 day period.

CERTIFIED ELECTRICAL CONTRACTOR STATEMENT - FOR USA ONLY

All electrical Installations that are preliminary to positioning of the equipment at the site prepared for the equipment shall be performed by licensed electrical contractors. Other connections between pieces of electrical equipment, calibrations and testing shall be performed by qualified GE Healthcare personnel. In performing all electrical work on these products, GE will use its own specially trained field engineers. All of GE's electrical work on these products will comply with the requirements of the applicable electrical codes.

The purchaser of GE equipment shall only utilize qualified personnel (i.e., GE's field engineers, personnel of third-party service companies with equivalent training, or licensed electricians) to perform electrical servicing on the equipment.

OMISSIONS & ERRORS

If there are any omissions, errors or suggestions for improving this documentation, please contact the GE Healthcare Global Documentation Group with specific information listing the system type, manual title, part number, revision number, page number and suggestion details.

Mail the information to:

Service Documentation,
GE Medical Systems (China) Co., Ltd.
No.19 Changjiang Road
WuXi National Hi-Tech Development Zone
Jiangsu, P.R China 214028
TEL: +86 510 85225888; FAX: +86 510 85226688

GE Healthcare employees should use TrackWise to report service documentation issues. These issues will then be in the internal problem reporting tool and communicated to the writer.

SERVICE SAFETY CONSIDERATIONS

 **DANGER DANGEROUS VOLTAGES, CAPABLE OF CAUSING DEATH, ARE PRESENT IN THIS EQUIPMENT. USE EXTREME CAUTION WHEN HANDLING, TESTING AND ADJUSTING.**

 **WARNING *Use all Personal Protection Equipment (PPE) such as gloves, safety shoes, safety glasses, and kneeling pad, to reduce the risk of injury.***

For a complete review of all safety requirements, see the Chapter 1, Safety Considerations section in the Service Manual.

LEGAL NOTES

The contents of this publication may not be copied or duplicated in any form, in whole or in part, without prior written permission of GE Healthcare.

GE Healthcare may revise this publication from time to time without written notice.

TRADEMARKS

All products and their name brands are trademarks of their respective holders.

COPYRIGHTS

All Material Copyright© 2005 to 2012 by General Electric Company Inc. All Rights Reserved.

Revision History

Revision	Date	Reason for change
1	24, Sep. 2004	Initial Release
2	08, Oct. 2004	Add one warning message
3	31, May 2005	Release of LOGIQ Book XP PRO; LOGIQ Book XP Vet
4	15, Jun. 2005	Add new CD-RW
5	25, Jul. 2005	WEEE Lable & New ACDC Release
6	18, Aug. 2005	Add new HP Printer
7	13, Sep. 2005	Release of ECG
8	10, May 2006	LOGIQ Book XP PRO R2.1.3 release
9	05, Feb. 2007	LOGIQ Book XP R2.1.4 release
10	15, Feb. 2007	Update Spare Parts
11	18, Apr. 2007	LOGIQ Book XP R2.1.5 Release
12	20, Jun. 2007	Add one note about periodic maintenance
13	19, Dec. 2007	Add one caution for CMOS battery
14	18, Sep. 2008	Add one label for battery
15	26, Nov. 2008	Delete section "Using a Phantom" and add Korean information
16	14, Jun. 2012	Add a description about instructing user to remove the battery and function check
17	17, Dec. 2012	Update package label and add new spare parts

List of Effected Pages (LOEP)

Pages	Revision	Pages	Revision	Pages	Revision
Title Page	17	3-1 to 3-40	17	8-1 to 8-6	17
Warnings i to -xii	17	4-1 to 4-32	17	9-1 to 9-12	17
TOC	17	5-1 to 5-33	17	10-1 to 10-20	17
1-1 to 1-16	17	6-1 to 6-2	17	Index	17
2-1 to 2-10	17	7-1 to 7-24	17	Back Cover	N/A

Table of Contents

CHAPTER 1

Introduction

Overview	1 - 1
Purpose of Chapter 1	1 - 1
Chapter Contents	1 - 1
Purpose of Service Manual	1 - 1
Typical Users of the Basic Service Manual	1 - 2
Purpose of Operator Manual(s)	1 - 2
Important Conventions	1 - 3
Conventions Used in Book	1 - 3
Standard Hazard Icons	1 - 4
Product Icons	1 - 5
Safety Considerations	1 - 8
Introduction	1 - 8
Human Safety	1 - 8
Mechanical Safety	1 - 8
Electrical Safety	1 - 9
Labels Locations	1 - 9
Battery Safety	1 - 10
Dangerous Procedure Warnings	1 - 11
Lockout/Tagout Requirements (For USA Only)	1 - 11
Returning/Shipping Probes and Repair Parts	1 - 12
EMC, EMI, and ESD	1 - 13
Electromagnetic Compatibility (EMC)	1 - 13
CE Compliance	1 - 13
Electrostatic Discharge (ESD) Prevention	1 - 13
Customer Assistance	1 - 14
Contact Information	1 - 14
System Manufacturer	1 - 15

CHAPTER 2

Pre Installation

Overview	2 - 1
Purpose of this chapter 2	2 - 1
Chapter Contents	2 - 1
General Console Requirements	2 - 2
Console Environmental Requirements	2 - 2
Lighting	2 - 2
Electrical Requirements	2 - 2
LOGIQ Book XP/XP PRO/XP Vet Power Requirements	2 - 2
Inrush Current	2 - 3
Site Circuit Breaker	2 - 3
Site Power Outlets	2 - 3
Unit Power Plug	2 - 3
Power Stability Requirements	2 - 3
EMI Limitations	2 - 4
Scan Probe Environmental Requirements	2 - 5
Facility Needs	2 - 6
Recommended Ultrasound Room Layout	2 - 6
Purchaser Responsibilities	2 - 6
Required Features	2 - 7
Desirable Features	2 - 7
Recommended and Alternate Ultrasound Room Layout	2 - 8
Networking Pre-installation Requirements	2 - 9
Stand Alone Scanner (without Network Connection)	2 - 9
Scanner Connected to Hospital's Network	2 - 9
Purpose of DICOM* Network Function	2 - 9
DICOM* Option Pre-installation Requirements	2 - 9

CHAPTER 3

Installation

Overview	3 - 1
Purpose of Chapter 3	3 - 1
Average Installation Time	3 - 2
Installation Warnings	3 - 2
Safety Reminders	3 - 3
Receiving and Unpacking the Equipment.	3 - 4
Moving into Position	3 - 7
Packing the Equipment.	3 - 7
Preparing for Installation.	3 - 8
Verify Customer Order	3 - 8
Physical Inspection	3 - 8
System Voltage Settings	3 - 8
EMI Protection	3 - 8
Completing the Installation	3 - 9
Power On / Boot Up	3 - 9
Scanner Power On	3 - 9
Turn on the system	3 - 10
Power Off/ Shutdown	3 - 10
Back-end Processor Power Down	3 - 10
Scanner Shutdown	3 - 11
Transducer Connection	3 - 11
System Configuration	3 - 12
System Specifications	3 - 12
Physical Dimensions	3 - 12
Electrical Specifications	3 - 13
Approved peripherals	3 - 13
Reference other peripherals and options	3 - 14
Connecting Cables	3 - 14
Peripherals/Accessories Connector Panel	3 - 14
Rear Panel Connector	3 - 14
Connect peripherals	3 - 18
Available Probes	3 - 25
Software/Option Configuration	3 - 26
Connectivity Installation Worksheet	3 - 27

Loading Base Image Software	3 - 28
Upgrading Application Software	3 - 30
Functional Check-out	3 - 33
Option Key Update	3 - 34
Probe Recognition	3 - 38
All the Peripheral Devices Work Properly	3 - 38
Reinstall DICOM Devices	3 - 39
Paperwork	3 - 40
Product Locator Installation	3 - 40
User Manual(s)	3 - 40

CHAPTER 4

Functional Checks

Overview	4 - 1
Purpose for Chapter 4	4 - 1
Required Equipment	4 - 1
General Procedure	4 - 2
Power On/Boot Up	4 - 2
Scanner Power On	4 - 2
Turn on the system	4 - 3
Power Off/ Shutdown	4 - 3
Back-end Processor Power Down	4 - 3
Scanner Shutdown	4 - 4
Archiving and Loading Presets	4 - 5
Archiving Presets to an CD-R disk	4 - 5
Loading Presets from an CD-R disk	4 - 5
Adjusting the Display Monitor	4 - 6
Brightness	4 - 6
Lockout/Tagout Requirements (For USA Only)	4 - 6
System Features	4 - 7
Control Panel	4 - 7
LOGIQ Book XP/XP PRO/XP Vet SoftMenu Key Tour	4 - 8
Monitor Display	4 - 9
B Mode Checks	4 - 10
Preparations	4 - 10
B Mode OP Panel Controls	4 - 11
B Mode Softmenu Key	4 - 12
M Mode Controls	4 - 13
Preparations	4 - 13
M Mode OP Panel Controls	4 - 14
M Mode Softmenu Key	4 - 15
Color Flow Mode Checks*	4 - 16
Preparations	4 - 16
Color Flow Mode OP Panel Controls	4 - 17
Color Flow Mode Softemenu Key	4 - 18
Doppler Mode Checks*	4 - 20
Preparations	4 - 20
Doppler Mode OP Panel Controls	4 - 21
Doppler Mode OP Panel Controls	4 - 22
Basic Measurements	4 - 24
Distance and Tissue Depth Measurements	4 - 24
Circumference/Area (Ellipse) Measurement	4 - 24
Worksheets	4 - 25

Report* Pages	4 - 25
Probe/Connectors Usage	4 - 25
Connecting a probe	4 - 25
Activating the probe	4 - 25
Deactivating the probe	4 - 25
Disconnecting the probe	4 - 25
Using Cine	4 - 26
Activating CINE	4 - 26
Quickly Move to Start/End Frame	4 - 26
Start Frame/End Frame	4 - 26
Adjusting the CINE Loop Playback Speed	4 - 26
Moving through a CINE Loop Frame By Frame	4 - 26
Image Management (QG)	4 - 26
Backup and Restore Database, Preset Configurations and Images	4 - 27
Formatting Media	4 - 27
Backup System Presets and Configurations	4 - 28
Restore System Presets and Configurations	4 - 29
Archiving Images	4 - 30
Software Configuration Checks	4 - 32
Peripheral Checks	4 - 32

CHAPTER 5

Components and Functions (Theory)

Overview	5 - 1
Block Diagrams and Theory	5 - 2
Block Diagram	5 - 2
General Information	5 - 5
Front End	5 - 6
The Back End	5 - 7
Top Console	5 - 7
External I/O	5 - 8
Peripherals	5 - 8
Wiring	5 - 9
PWA (Printed Wire Assembly) Assy Diagrams	5 - 10
MST	5 - 10
Description	5 - 11
DFP	5 - 12
Description	5 - 13
DTX	5 - 14
Description	5 - 14
DCNN	5 - 15
Description	5 - 15
Keyboard	5 - 16
Scan Control Board LEDs	5 - 17
Power Diagrams	5 - 18
Overview	5 - 18
AC Power	5 - 18
DC Power (Low Voltage)	5 - 19
Battery charging	5 - 20
Rear Panel	5 - 20
Air Flow Distribution	5 - 21
Fans	5 - 22
Common Service Platform	5 - 23
Introduction	5 - 23
Global Service User Interface (GSUI)	5 - 23
Internationalization	5 - 23
Service Login	5 - 23
Access / Security	5 - 23
The usage for security cable	5 - 24
Service Home Page	5 - 25

Error Logs Tab (Not available on LOGIQ Book XP/XP PRO/XP Vet now)	5 - 26
Logs	5 - 27
Utilities	5 - 28
Search	5 - 28
Exit	5 - 29
Diagnostics	5 - 30
Diagnostics Execution	5 - 30
Diagnostic Reports	5 - 30
Image Quality	5 - 31
Calibration	5 - 31
Configuration	5 - 32
Utilities	5 - 32
Replacement	5 - 32
PM	5 - 33

CHAPTER 6

Service Adjustments

Overview.	6 - 1
Purpose of this chapter 6	6 - 1
Monitor Adjustments.	6 - 2
Adjustments Procedures	6 - 2

CHAPTER 7

Diagnostics/Troubleshooting

Overview	7 - 1
Purpose of Chapter 7	7 - 1
Gathering Trouble Data	7 - 2
Overview	7 - 2
Collect Vital System Information	7 - 2
Collect a Trouble Image with Logs	7 - 3
Screen Captures	7 - 4
Check and Record the P3 Key Function	7 - 4
Setting the P3 Key to Screen Capture	7 - 5
Capturing a Screen	7 - 6
Reset the P3 Key to Customer's Functionality	7 - 7
Global Service User Interface (GSUI)	7 - 8
Enter global service user interface	7 - 8
Active Diagnostic Function	7 - 10
Reset Database	7 - 11
Clean Userdefs	7 - 13
Update FPGA	7 - 15
Control Frame	7 - 15
Button	7 - 15
Loop Count	7 - 15
Progress Indicator	7 - 16
Short Text Message	7 - 16
Background Color	7 - 16
Common Diagnostics	7 - 17
Utilities	7 - 17
Disruptive Mode	7 - 17
System Shutdown	7 - 17
PC Diagnostics (Non-Interactive Tests)	7 - 18
CPU Tests	7 - 18
Hard Drive Tests	7 - 18
Memory Tests	7 - 18
CD/DVD Drive Test	7 - 18
Video Test	7 - 18
USB Test	7 - 18
PC Diagnostics (Interactive Tests)	7 - 18
Keyboard Test	7 - 18
LCD Test	7 - 18

LOGIQ Book XP/XP PRO/XP Vet Diagnostic Descriptions	7 - 19
Troubleshooting	7 - 19
FRU Test	7 - 20
MST	7 - 20
DFP	7 - 21
DTX	7 - 22
DCNN	7 - 23
PC	7 - 24

CHAPTER 8

Replacement Procedures

Overview	8 - 1
Purpose of Chapter 8	8 - 1
Disassembly/Re-assembly	8 - 1
Warning and Caution	8 - 1
Handle Assy (FRU No. 312)	8 - 2
Tools	8 - 2
Needed Manpower	8 - 2
Preparations	8 - 2
Removal Procedure	8 - 2
Mounting procedure	8 - 2
Trackball Roller Cleaning	8 - 4
Tools	8 - 4
Needed Manpower	8 - 4
Preparations	8 - 4
Procedure	8 - 4

CHAPTER 9

Renewal Parts

Overview	9 - 1
Purpose of Chapter 9	9 - 1
List of Abbreviations	9 - 1
Renewal Parts Lists	9 - 2
Equipment Models Covered in this Chapter	9 - 2
Operator Console Assy	9 - 3
Keyboard Assy	9 - 4
Bottom Assy	9 - 4
Isolation Cart Components	9 - 5
Accessories and Kits	9 - 7
Manuals	9 - 10
Probes	9 - 11

CHAPTER 10

Care & Maintenance

Overview	10 - 1
Periodic Maintenance Inspections	10 - 1
Purpose of Chapter 10	10 - 1
Why do Maintenance	10 - 2
Keeping Records	10 - 2
Quality Assurance	10 - 2
Maintenance Task Schedule	10 - 2
How often should care & maintenance tasks be performed?	10 - 2
Tools Required	10 - 4
Special Tools, Supplies and Equipment	10 - 4
Specific Requirements for Care & Maintenance	10 - 4
System Maintenance	10 - 5
Preliminary Checks	10 - 5
Functional Checks (See Also Chapter 4)	10 - 6
System Checks	10 - 6
Peripheral/Option Checks	10 - 7
Input Power	10 - 7
AC/DC Adapter Inspection	10 - 7
Cleaning	10 - 7
General Cleaning	10 - 7
Physical Inspection	10 - 8
<u>Optional</u> Diagnostic Checks	10 - 9
View the Logs	10 - 9
Probe Maintenance	10 - 9
Probe Related Checks	10 - 9
Basic Probe Care	10 - 9
Basic Probe Cleaning	10 - 9
Battery Performance Maintenance	10 - 10
Electrical Safety Tests	10 - 11
Safety Test Overview	10 - 11
GEMS Leakage Current Limits	10 - 12
Outlet Test - Wiring Arrangement	10 - 13
Chassis Leakage Current Test	10 - 14
Definition	10 - 14
Generic Procedure	10 - 14
Data Sheet for enclosure Source Leakage Current	10 - 15

Probe Leakage Current Test	10 - 16
Definition	10 - 16
Generic Procedure	10 - 16
Meter Procedure Using Probe Adapter	10 - 16
No Meter Probe Adapter Procedure	10 - 16
Data Sheet for Transducer Source Leakage Current	10 - 17
When There's Too Much Leakage Current.....	10 - 18

Chapter 1

Introduction

Section 1-1 Overview

1-1-1 Purpose of Chapter 1

This chapter describes important issues related to safely servicing this ultrasound machine. The service provider must read and understand all the information presented here before installing or servicing a unit.

1-1-2 Chapter Contents

Table 1-1 Contents in Chapter 1

Section	Description	Page Number
1-1	Overview	1-1
1-2	Important Conventions	1-3
1-3	Safety Considerations	1-8
1-4	EMC, EMI, and ESD	1-13
1-5	Customer Assistance	1-14

1-1-3 Purpose of Service Manual

This Service Manual provides service information for the LOGIQ Book XP/XP PRO/XP Vet Ultrasound Scanning System. It contains the following chapters:

- 1.) **Chapter 1 - Introduction:** Contains a content summary and warnings.
- 2.) **Chapter 2 - Pre Installation:** Contains pre-installation requirements for the LOGIQ Book XP/XP PRO/XP Vet.
- 3.) **Chapter 3 - Installation:** Contains installation procedures.
- 4.) **Chapter 4 - Functional Checks:** Contains functional checks that are recommended as part of the installation, or as required during servicing and periodic maintenance.
- 5.) **Chapter 5 - Components and Functions (Theory):** Contains block diagrams and functional explanations of the electronics.
- 6.) **Chapter 6 - Service Adjustments:** Contains instructions on how to make available adjustments to the LOGIQ Book XP/XP PRO/XP Vet.
- 7.) **Chapter 7 - Diagnostics/Troubleshooting:** Provides procedures for running diagnostic or related routines for the LOGIQ Book XP/XP PRO/XP Vet.
- 8.) **Chapter 8 - Replacement Procedures:** Provides disassembly procedures and reassembly procedures for all changeable Field Replaceable Units (FRU).
- 9.) **Chapter 9 - Renewal Parts:** Contains a complete list of field replaceable parts for the LOGIQ Book XP/XP PRO/XP Vet.
- 10.) **Chapter 10 - Care & Maintenance:** Provides periodic maintenance procedures for the LOGIQ Book XP/XP PRO/XP Vet.

1-1-4 Typical Users of the Basic Service Manual

- Service Personnel (installation, maintenance, etc.).
- Hospital's Service Personnel
- Contractors (Some parts of Chapter 2 - Pre-Installation)

1-1-5 Purpose of Operator Manual(s)

The Operator Manual(s) should be fully read and understood before operating the LOGIQ Book XP/XP PRO/XP Vet and also kept near the unit for quick reference.

Section 1-2 Important Conventions





1-2-1 Conventions Used in Book

Icons

Pictures, or icons, are used wherever they reinforce the printed message. The icons, labels and conventions used on the product and in the service information are described in this chapter.

Safety Precaution Messages

Various levels of safety precaution messages may be found on the equipment and in the service information. The different levels of concern are identified by a flag word that precedes the precautionary message. Known or potential hazards are labeled in one of following ways:







-  **DANGER** **DANGER IS USED TO INDICATE THE PRESENCE OF A HAZARD THAT WILL CAUSE SEVERE PERSONAL INJURY OR DEATH IF THE INSTRUCTIONS ARE IGNORED.**
-  **WARNING** **WARNING IS USED TO INDICATE THE PRESENCE OF A HAZARD THAT CAN CAUSE SEVERE PERSONAL INJURY AND PROPERTY DAMAGE IF INSTRUCTIONS ARE IGNORED.**
-  **CAUTION** **Caution is used to indicate the presence of a hazard that will or can cause minor personal injury and property damage if instructions are ignored.**
-  **NOTICE** **Equipment Damage Possible**
Notice is used when a hazard is present that can cause property damage but has absolutely no personal injury risk.
Example: Disk drive will crash.

NOTE: *Notes provide important information about an item or a procedure. Information contained in a NOTE can often save you time or effort.*

1-2-2 Standard Hazard Icons



Important information will always be preceded by the exclamation point contained within a triangle, as seen throughout this chapter. In addition to text, several different graphical icons (symbols) may be used to make you aware of specific types of hazards that could cause harm.

Table 1-2 Standard Hazard Icons

ELECTRICAL	MECHANICAL	RADIATION
		
LASER	HEAT	PINCH
		

Other hazard icons make you aware of specific procedures that should be followed.

Table 1-3 Standard Icons Indicating a Special Procedure Be Used

AVOID STATIC ELECTRICITY	TAG AND LOCK OUT	WEAR EYE PROTECTION
		 <p data-bbox="1190 1381 1382 1436">EYE PROTECTION</p>

1-2-3 Product Icons

The following table describes the purpose and location of safety labels and other important information provided on the equipment.

Table 1-4 Warnings





LABEL/SYMBOL	PURPOSE/MEANING	LOCATION
Identification and Rating Plate	<ul style="list-style-type: none"> • Manufacture's name • Date of manufacture • Model and serial numbers • Electrical ratings (Volts, Amps, phase, and frequency) 	Bottom panel of the console
Type/Class Label	Used to indicate the degree of safety or protection.	Bottom panel of the adapter.
IP Code (IPX1)	Indicates the degree of protection provided by the enclosure per IEC60 529. Can not be used in operating room environment.	Footswitch
	Equipment Type BF (man in the box symbol) IEC 878-02-03 indicates B Type equipment having a floating applied part.	Probe connectors
	"CAUTION" The equilateral triangle is usually used in combination with other symbols to advise or warn the user.	Various
	General Warning.	Various
	"Consult accompanying documents" is intended to alert the user to refer to the operator manual or other instructions when complete information cannot be provided on the label.	Various
	Do not push the system.	Rear of Docking Cart/Isolation Cart
	"CAUTION - Dangerous voltage" (the lightning flash with arrowhead in equilateral triangle) is used to indicate electric shock hazards.	Various

Table 1-4 Warnings



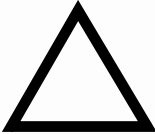





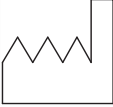

LABEL/SYMBOL	PURPOSE/MEANING	LOCATION
	<p>“ON” indicates the power on position of the power switch. “Off” indicates the power Off position of the power switch. CAUTION This Power Switch DOES NOT ISOLATE Mains Supply</p>	<p>LCD Cover On/Off Switch</p>
	<p>“Protective Earth” indicates the protective earth (grounding) terminal.</p>	<p>Inside of AC adapter</p>
	<p>“TUV” Listing and Certification Mark is used to designate conformance to nationally recognized product safety standards. The Mark bears the name and /or logo of the testing laboratory, product category, safety standard is assessed and a control number.</p>	<p>Bottom panel of the console</p>
	<p>Date of manufacture. The date could be a year, year and month, or year, month and day, as appropriate. See ISO 8601 for date formats.</p>	<p>Rating Plate</p>
	<p>Catalog or model number.</p>	<p>Rating Plate</p>
	<p>Serial number</p>	<p>Rating Plate</p>
	<p>Equipment Class II. For products not relying protective earth such as products having double or reinforced insulation.</p>	<p>Rating Plate</p>
	<p>Direct Current. For products to be powered from a DC supply.</p>	<p>Rating Plate</p>
	<p>Type CF Defib-Proof Applied Part (heart in the box with paddle) symbol is in accordance with IEC 60878-02-06.</p>	<p>ECG Module</p>
	<p>Do not connect the CD-RW to system while scanning</p>	<p>CD-RW</p>

Table 1-4 Warnings

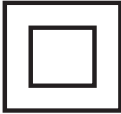
LABEL/SYMBOL	PURPOSE/MEANING	LOCATION
	<p>This symbol indicates that the waste of electrical and electronic equipment must not be disposed as unsorted municipal waste and must be collected separately. Please contact an authorized representative of the manufacturer for information concerning the decommissioning of your equipment.</p>	<p>Rating Plate</p>
	<p>Indicates the product contains hazardous materials in excess of the limits established by Chinese standard SJ/T11363-2006 Requirements for Concentration Limits for Certain Hazardous Substances in Electronic Information Products. The number in the symbol is the Environment-friendly Use Period (EFUP), which indicates the period during which the toxic or hazardous substances or elements contained in electronic information products will not leak or mutate under normal operating conditions so that the use of such electronic information products will not result in any severe environmental pollution, any bodily injury or damage to any assets.</p>	<p>Rear panel, rating plate</p>
	<p>The separate collection symbol is affixed to a battery, or its packaging, to advise you that the battery must be recycled or disposed of in accordance with local or country laws. The letters below the separate collection symbol indicate whether certain elements (Pb=Lead, Cd=Cadmium, Hg=Mercury) are contained in the battery. To minimize potential effects on the environment and human health, it is important that all marked batteries that you remove from the product are properly recycled or disposed. For information on how the battery may be safely removed from the device, please consult the service manual or equipment instructions. Information on the potential effects on the environment and human health of the substances used in batteries is available at this url: http://www.gehealthcare.com/euen/weee-recycling/index.html</p>	<p>Battery pack</p>
	<p>This product consists of devices that may contain mercury, which must be recycled or disposed of in accordance with local, state, or country laws. (Within this system, the backlight lamps in the monitor display contain mercury.)</p>	<p>Bottom panel of the console</p>

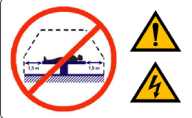
Section 1-3 Safety Considerations

1-3-1 Introduction

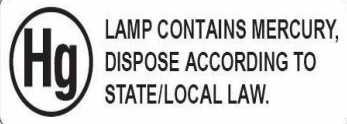
The following safety precautions must be observed during all phases of operation, service and repair of this equipment. Failure to comply with these precautions or with specific warnings elsewhere in this manual, violates safety standards of design, manufacture and intended use of the equipment.

1-3-2 Human Safety

Operating personnel must not remove the system covers.
Servicing should be performed by authorized personnel only.
Only personnel who have participated in a LOGIQ Book XP/XP PRO/XP Vet Training are authorized to service the equipment.

1-3-3 Mechanical Safety

 **WARNING** *Ultrasound probes are highly sensitive medical instruments that can easily be damaged by improper handling. Use care when handling and protect from damage when not in use. Do not use a damaged or defective probe. Failure to follow these precautions can result in serious injury and equipment damage.*

 **WARNING** *Never use a probe that has fallen to the floor. Even if it looks ok, it may be damaged.*

 **CAUTION** The LOGIQ Book XP/XP PRO/XP Vet weights 4.3kg or more, depending on installed peripherals, when ready for use. To avoid possible injury and equipment damage:
ALWAYS:

- Use the handle to move the system.
- Do not let the system strike walls or door frame.
- Limit movement to a slow careful walk.

NOTE: *Special care should be taken when transporting the unit in a vehicle:*

- *Before transporting, place the system in its special storage case.*
- *Ensure that the system is firmly secured while inside the vehicle.*
- *Secure system with straps or as directed otherwise to prevent motion during transport.*
- *Prevent vibration damage by driving cautiously. Avoid unpaved roads, excessive speeds, and erratic stops or starts.*

1-3-4 Electrical Safety

To minimize shock hazard, the equipment chassis must be connected to an electrical ground. The system is equipped with a three-conductor AC power cable. This must be plugged into an approved electrical outlet with protective ground.

The power outlet used for this equipment should not be shared with other types of equipment.

Both the system power cable and the power connector meet international electrical standards.

1-3-5 Labels Locations

Please refer to Basic User Manual for label location information.

1-3-6 Battery Safety

To avoid the risk of injury, follow the warning and cautions to make sure that the battery does not burst, ignite, or generate heat of fumes.



- WARNING**
- The battery has a safety device. Do not disassemble or alter the battery.
 - Charge the batteries only when the ambient temperature is between 0° and 40° C (32° and 104° F).
 - Do not short-circuit the battery by directly connecting the negative terminals with metal objects.
 - Do not heat the battery or discard it in a fire.
 - Do not expose the battery to temperature over 60° C (140° F). Keep it away from fire and other heat sources.
 - Do not charge the battery near a heat source, such as a fire or heater.
 - Do not leave the battery in direct sunlight.
 - Do not drop packs from height to prevent them from possible malfunction damage.
 - Do not pierce the battery with a sharp object, hit it, or step on it.
 - Do not use a damaged battery.
 - Do not solder a battery.
 - Do not connect the battery to an electrical power outlet.
 - Do not contact PCM (Power Control and Monitor, it is a small board in the battery) directly to prevent packs from ESD damage.
 - In the case of longer non-use of the LOGIQ Book XP/XP PRO/XP Vet, please make sure the battery is removed.



- CAUTION** To avoid the battery bursting, igniting, or fumes from the battery causing equipment damage, observe the following precautions:
- Do not immerse the battery in water or allow it to get wet.
 - Do not put the battery into a microwave oven or pressurized container.
 - If the battery leaks or emits an odor, remove it from all possible flammable sources.
 - If the battery emits an odor or heat, is deformed or discolored, or in a way appears abnormal during use, recharging or storage, immediately remove it and stop using it. If you have any questions about the battery, consult GE or your local representative.
 - Store the battery between -20° C (-4° F) and 60° C (140°F).
 - Use only GE recognized batteries.
 - In case of the long term (3 months or more) storage:
 - Store the battery in a temperature range of 10° C (50° F) and 30° C (86°F).
 - When charging for the first time after long-term storage. Recover such packs to original performance through repeating several cycles of full charging and discharging.
 - When store packs for more than 6 months, charge at least once per 6 months to prevent leakage and deterioration in performance due to self-discharging.
 - When the system isn't powered on continuously more than 6 months, in order to prevent leakage and deterioration in performance of CMOS battery, power on the system at least once per 6 months for more than 15 hours to have CMOS battery fully charged. Time and date need to be re-setup.



- NOTICE** The battery shall be shipped in about 30% charged state. Those packs have to be fully charged and discharged up to 3 times to utilize Li-Ion smart packs before use.

1-3-7 Dangerous Procedure Warnings

Warnings, such as the examples below, precede potentially dangerous procedures throughout this manual. Instructions contained in the warnings must be followed.

 **DANGER** **DANGEROUS VOLTAGES, CAPABLE OF CAUSING DEATH, ARE PRESENT IN THIS EQUIPMENT. USE EXTREME CAUTION WHEN HANDLING, TESTING AND ADJUSTING.**



 **WARNING** **EXPLOSION WARNING**
DO NOT OPERATE THE EQUIPMENT IN AN EXPLOSIVE ATMOSPHERE. OPERATION OF ANY ELECTRICAL EQUIPMENT IN SUCH AN ENVIRONMENT CONSTITUTES A DEFINITE SAFETY HAZARD.

 **WARNING** **DO NOT SUBSTITUTE PARTS OR MODIFY EQUIPMENT**
BECAUSE OF THE DANGER OF INTRODUCING ADDITIONAL HAZARDS, DO NOT INSTALL SUBSTITUTE PARTS OR PERFORM ANY UNAUTHORIZED MODIFICATION OF THE EQUIPMENT.

 **WARNING** **SHUT DOWN FORCEDLY OR PLUG IN/OUT ACDC INVALID MAY CAUSE THE DAMAGE OF SYSTEM FILES.**



1-3-8 Lockout/Tagout Requirements (For USA Only)

Follow OSHA Lockout/Tagout requirements (USA) or local Lockout/Tagout requirements by ensuring you are in total control of the AC power plug at all times during the service process.

To apply Lockout/Tagout:

- 1.) Plan and prepare for shutdown.
- 2.) Shutdown the equipment.
- 3.) Isolate the equipment.
- 4.) Apply Lockout/Tagout Devices.
- 5.) Remove battery.
- 6.) Control all stored and residual energy.
- 7.) Verify isolation.

All potentially hazardous stored or residual energy is relieved.

	NOTICE Energy Control and Power Lockout for LOGIQ Book XP/XP PRO/XP Vet
	WHEN SERVICING PARTS OF THE SYSTEM WHERE THERE IS EXPOSURE TO VOLTAGE GREATER THAN 30 VOLTS: 1. TURN OFF THE SCANNER. 2. UNPLUG THE SYSTEM. 3. MAINTAIN CONTROL OF THE SYSTEM POWER PLUG. 4. WAIT FOR AT LEAST 20 SECONDS FOR CAPACITORS TO DISCHARGE AS THERE ARE NO TEST POINTS TO VERIFY ISOLATION. THE AMBER LIGHT ON THE OP PANEL ON/OFF BUTTON WILL TURN OFF. 5. REMOVE THE SYSTEM BATTERY.

1-3-9 Returning/Shipping Probes and Repair Parts

Equipment being returned must be clean and free of blood and other infectious substances.

GEMS policy states that body fluids must be properly removed from any part or equipment prior to shipment. GEMS employees, as well as customers, are responsible for ensuring that parts/equipment have been properly decontaminated prior to shipment. Under no circumstance should a part or equipment with visible body fluids be taken or shipped from a clinic or site (for example, body coils or an ultrasound probe).

The purpose of the regulation is to protect employees in the transportation industry, as well as the people who will receive or open this package.

NOTE: *The US Department of Transportation (DOT) has ruled that “items that were saturated and/or dripping with human blood that are now caked with dried blood; or which were used or intended for use in patient care” are “regulated medical waste” for transportation purposes and must be transported as a hazardous material.*

NOTE: *The USER/SERVICE staff should dispose all the waste properly as per federal, state, and local waste disposal regulation.*

The ultrasound system is not meant to be long term storage of patient data or images. The user is responsible for the data on the system and a regular backup is highly recommended.

If the system is sent for repair, please ensure that any patient information is backup and erased from the system before shipping. It is always possible during system failure and repair to lose patient data. GE is not responsible for the loss of this data.

If PHI (Patient Healthcare Information) data needs to be sent to GE employees for service purposes, GE will ascertain agreement from the customer. The patient information shall only be transferred by approved service processes, tools and devices restricting access, protecting or encrypting data where required, and providing traceability in the form of paper or electronic documents at each stage of the procedure while maintaining compliance with cross-border restrictions of patient information transfers.

Section 1-4 EMC, EMI, and ESD

1-4-1 Electromagnetic Compatibility (EMC)

Electromagnetic compatibility describes a level of performance of a device within its electromagnetic environment. This environment consists of the device itself and its surroundings including other equipment, power sources and persons with which the device must interface. Inadequate compatibility results when a susceptible device fails to perform as intended due to interference from its environment or when the device produces unacceptable levels of emission to its environment. This interference is often referred to as radio-frequency or electromagnetic interference (RFI/EMI) and can be radiated through space or conducted over interconnecting power or signal cables. In addition to electromagnetic energy, EMC also includes possible effects from electrical fields, magnetic fields, electrostatic discharge and disturbances in the electrical power supply.

1-4-2 CE Compliance

The LOGIQ Book XP/XP PRO/XP Vet unit conforms to all applicable conducted and radiated emission limits and to immunity from electrostatic discharge, radiated and conducted RF fields, magnetic fields and power line transient requirements.

For applicable standards refer to the Safety Chapter in the Basic User Manual.

NOTE: *For CE Compliance, it is critical that all covers, screws, shielding, gaskets, mesh, clamps, are in good condition, installed tightly without skew or stress. Proper installation following all comments noted in this service manual is required in order to achieve full EMC performance.*

1-4-3 Electrostatic Discharge (ESD) Prevention



WARNING

DO NOT TOUCH ANY BOARDS WITH INTEGRATED CIRCUITS PRIOR TO TAKING THE NECESSARY ESD PRECAUTIONS:

1.FOLLOW GENERAL GUIDELINES FOR HANDLING OF ELECTROSTATIC SENSITIVE EQUIPMENT.



Section 1-5 Customer Assistance

1-5-1 Contact Information

If this equipment does not work as indicated in this service manual or in the User Manual, or if you require additional assistance, please contact the local distributor or appropriate support resource, as listed below.

Prepare the following information before you call:

- System ID serial number.
- Software version.

Table 1-5 Phone Numbers for Customer Assistance

Location	Phone Number	
USA GE Medical Systems Ultrasound Service Engineering 9900 Innovation Drive Wauwatosa, WI 53226	Service: On-site	1-800-437-1171
	Service: Parts	1-800-558-2040
	Applications support	1-800-682-5327 or 1-262-524-5698
Canada		1-800-668-0732
Latin America	Service	1-800-321-7937
	Applications Support	1-262-524-5698
Europe GE Ultraschall Deutschland GmbH & Co. KG BeethovenstraBe 239 Postfach 11 05 60, D-42665 Solingen Germany	Phone: +33 (0)130-831-300 (General Imaging and Cardiac) Fax: +49 (0)212-2802-431	
Asia (Singapore) GE Ultrasound Asia Service Department - Ultrasound 298 Tiong Bahru Road #15-01/06 Central Plaza Singapore 169730	Tel: +65 6291-8528 Fax: +65 272-3997 +81 426-482902	
Japan support Center	Phone: 81-42-648-2944 Fax: 81-42-648-2905	

1-5-2 System Manufacturer

Table 1-6 System Manufacturer

Manufacturer	Phone Number
GE Medical Systems (China) Co., Ltd. No.19, Changjiang Road, Wuxi National Hi-Tech Dev. Zone, Jiangsu, P.R. China 214028	TEL: +86 510-85225888 FAX: +86 510-85226688
GE Ultrasound Korea: 65-1, Sangdaewon-dong, Jungwon-gu, Seongnam-si, Gyeonggi-do, Korea 462-120	TEL : +82-31-740-6112 FAX: +82-31-740-6435

This page was intentionally left blank.

Chapter 2

Pre Installation

Section 2-1 Overview

2-1-1 Purpose of this chapter 2

This chapter provides the information required to plan and prepare for the installation of a LOGIQ Book XP/XP PRO/XP Vet. Included are descriptions of the facility and electrical needs to be met by the purchaser of the unit.

2-1-2 Chapter Contents

Table 2-7 Contents in Chapter 2

Section	Description	Page Number
2-1	Overview	2-1
2-2	General Console Requirements	2-2
2-3	Facility Needs	2-6

Section 2-2 General Console Requirements

2-2-1 Console Environmental Requirements

Table 2-8 Environmental Requirements for LOGIQ Book XP/XP PRO/XP Vet Scanners

	Operational	Storage	Transport
Temperature	10 - 40 degree C	-5 - 50 degree C	-5 - 50 degree C
Humidity	30 - 75% non-condensing	10 - 90% non-condensing	10 - 90% non-condensing
Pressure	700 - 1060hPa	700 - 1060hPa	700 - 1060hPa
Temperatures in degree C, conversion to degree F = (degree C*(9/5) + 32)			

2-2-1-1 Lighting

Bright light is needed for system installation, updates and repairs. However, operator and patient comfort may be optimized if the room light is subdued and indirect. Therefore a combination lighting system (dim/bright) is recommended. Keep in mind that lighting controls and diameters can be a source of EMI which could degrade image quality. These controls should be selected to minimize possible interface.

2-2-2 Electrical Requirements

NOTE: *GE Medical Systems requires a dedicated power and ground for the proper operation of its Ultrasound equipment. This dedicated power shall originate at the last distribution panel before the system.*

Sites with a mains power system with defined Neutral and Live:

The dedicated line shall consist of one phase, a neutral (not shared with any other circuit), and a full size ground wire from the distribution panel to the Ultrasound outlet.

Sites with a mains power system without a defined Neutral:

The dedicated line shall consist of one phase (two lines), not shared with any other circuit, and a full size ground wire from the distribution panel to the Ultrasound outlet.

Please note that image artifacts can occur, if at any time within the facility, the ground from the main facility's incoming power source to the Ultrasound unit is only a conduit.

2-2-2-1 LOGIQ Book XP/XP PRO/XP Vet Power Requirements

Table 2-9 Electrical Specifications for LOGIQ Book XP/XP PRO/XP Vet

Adapter Name	Voltage	Power	Tolerances	Current	Frequency
ADM-9020M-GE	100-240 VAC	108VA	±10%	1.08-0.45A	50-60HZ

2-2-2-2 Inrush Current

Inrush current is not a factor to consider due to the inrush current limiting properties of the power supplies.

Table 2-10 Inrush Current

Voltage	Inrush Current	
	Console Only	Console with all peripherals
100V	0.38A	0.41A
240V	0.20A	0.21A

2-2-2-3 Site Circuit Breaker

It is recommended that the branch circuit breaker for the machine be readily accessible.

2-2-2-4 Site Power Outlets

A dedicated AC power outlet must be within reach of the unit without extension cords. Other adequate outlets for the external peripherals, medical and test equipment needed to support this unit must also be present within 1 m (3.2 ft.) of the unit. Electrical installation must meet all current local, state, and national electrical codes.

2-2-2-5 Unit Power Plug

If the unit arrives without a power plug, or with the wrong plug, you must contact your GE dealer or the installation engineer must supply what is locally required.

2-2-2-6 Power Stability Requirements

Voltage drop-out

Max 10 ms.

Power Transients

(All applications)

Less than 25% of nominal peak voltage for less than 1 millisecond for any type of transient, including line frequency, synchronous, asynchronous, or aperiodic transients.

2-2-3 EMI Limitations

Ultrasound machines are susceptible to Electromagnetic Interference (EMI) from radio frequencies, magnetic fields, and transient in the air wiring. They also generate EMI. The LOGIQ Book XP/XP PRO/XP Vet complies with limits as stated on the EMC label. However there is no guarantee that interface will not occur in a particular installation.

Possible EMI sources should be identified before the unit is installed.

Electrical and electronic equipment may produce EMI unintentionally as the result of defect.

These sources include:

- medical lasers,
- scanners,
- cauterizing guns,
- computers,
- monitors,
- fans,
- gel warmers,
- microwave ovens,
- light dimmers,
- portable phones.

The presence of a broadcast station or broadcast van may also cause interference.

See [Table 2-11](#) for EMI Prevention tips.

Table 2-11 EMI Prevention/abatement

EMI Rule	Details
Be aware of RF sources	Keep the unit at least 5 meters or 15 feet away from other EMI sources. Special shielding may be required to eliminate interference problems caused by high frequency, high powered radio or video broadcast signals.
Ground the unit	Poor grounding is the most likely reason a unit will have noisy images. Check grounding of the power cord and power outlet.
Replace all screws, RF gaskets, covers, cores	After you finish repairing or updating the system, replace all covers and tighten all screws. Any cable with an external connection requires a magnet wrap at each end. Install the shield over the front of card cage. Loose or missing covers or RF gaskets allow radio frequencies to interfere with the ultrasound signals.
Replace broken RF gaskets	If more than 20% or a pair of the fingers on an RF gasket are broken, replace the gasket. Do not turn on the unit until any loose metallic part is removed.
Do not place labels where RF gaskets touch metal	Never place a label where RF gaskets meet the unit. Otherwise, the gap created will permit RF leakage. Or, if a label has been found in such a position, move the label.
Use GE specified harnesses and peripherals	The interconnect cables are grounded and require ferrite beads and other shielding. Also, cable length, material, and routing are all important; do not change from what is specified.
Take care with cellular phones	Cellular phones may transmit a 5 V/m signal; that could cause image artifacts.
Properly dress peripheral cables	Do not allow cables to lie across the top of the card cage or hang out of the peripheral bays. Loop the excess length for peripheral cables inside the peripheral bays. Attach the monitor cables to the frame.

2-2-4 Scan Probe Environmental Requirements

Operation: 10° to 40° C

Storage: -10° to 60° C

*NOTE: Temperature in degrees C. Conversion to Degrees F = (Degrees C * (9/5) + 32).*



NOTICE SYSTEMS AND ELECTRONIC PROBES ARE DESIGNED FOR STORAGE TEMPERATURES OF -10 TO + 60 degrees C. WHEN EXPOSED TO LARGE TEMPERATURE VARIATIONS, THE PRODUCT SHOULD BE KEPT IN ROOM TEMPERATURE FOR 10 HOURS BEFORE USE.

Section 2-3 Facility Needs

2-3-1 Recommended Ultrasound Room Layout

2-3-1-1 Purchaser Responsibilities

The work and materials needed to prepare the site is the responsibility of the purchaser. Delay, confusion, and waste of manpower can be avoided by completing pre installation work before delivery. User the Pre Installation checklist to verify that all needed steps have been taken, Purchaser reasonability includes:

- Procuring the materials required.
- Completing the preparations before delivery of the ultrasound system.
- Paying the costs for any alternations and modifications not specifically provided in the sales contract.

NOTE: *All electrical installation that are preliminary to the positioning of the equipment at the site prepared for the equipment must be performed by licensed electrical contractors. Other connections between pieces of electrical equipment, products involved (and the accompanying electrical installations) are highly sophisticated and special engineering competence is required. All electrical work on these product must comply with the requirements of applicable electrical codes. The purchaser of GE equipment must only utilize qualified personnel to perform electrical servicing on the equipment.*

The desire to use a non-listed or customer provided product or to place an approved product further from the system than the interface kit allows presents challenges to the installation team. To avoid delays during installation, such variances should be made known to the individuals or group performing the installation at the earliest possible date (preferable prior to purchase).

The ultrasound suite must be clean prior to delivery of the machine. Carpet is not recommended because it collects dust and creates static. Potential sources of EMI (electromagnetic interference) should also be investigated before delivery. Dirt, static, and EMI can negatively impact system.

2-3-2 Required Features

NOTE: *GE Medical Systems requires a dedicated power and ground for the proper operation of its Ultrasound equipment. This dedicated power shall originate at the last distribution panel before the system.*

Sites with a mains power system with defined Neutral and Live:

The dedicated line shall consist of one phase, a neutral (not shared with any other circuit), and a full size ground wire from the distribution panel to the Ultrasound outlet.

Sites with a mains power system without a defined Neutral:

The dedicated line shall consist of one phase (two lines), not shared with any other circuit, and a full size ground wire from the distribution panel to the Ultrasound outlet.

Please note that image artifacts can occur, if at any time within the facility, the ground from the main facility's incoming power source to the Ultrasound unit is only a conduit.

- Dedicated single branch power outlet of adequate amperage meeting all local and national codes which is located less than 2.5 m (8 ft.) from the unit's proposed location
- Door opening is at least 76 cm (30 in) wide
- Proposed location for unit is at least 0.2m (0.67 ft.) from the wall for cooling
- Power outlet and place for any external peripheral are within 2 m (6.5 ft.) of each other with peripheral within 1 m of the unit to connect cables.
- Power outlets for other medical equipment and gel warmer
- Power outlets for test equipment and modem within 1 m (3.2 ft.) of unit
- Clean and protected space to store transducers (in their cases or on a rack)
- Material to safely clean probes (done with a plastic container, never metal)

2-3-3 Desirable Features

- Door is at least 92 cm (3 ft.) wide
- Circuit breaker for dedicated power outlet is easily accessible
- Sink with hot and cold water
- Receptacle for bio-hazardous waste, like used probe sheaths
- Emergency oxygen supply
- Storage for linens and equipment
- Nearby waiting room, lavatory, and dressing room
- Dual level lighting (bright and dim)
- Lockable cabinet ordered by GE for its software and proprietary manuals.

2-3-3-1 Recommended and Alternate Ultrasound Room Layout

Recommended standard floor plan and a minimal floor plan for ultrasound equipment:

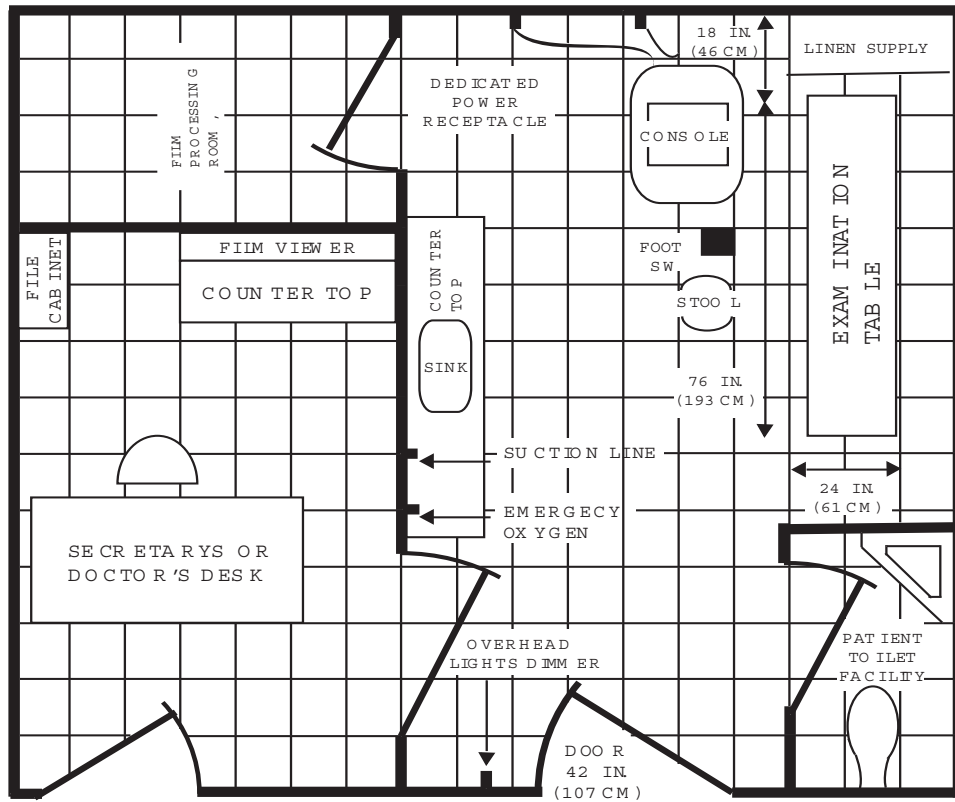

A 14 by 17 foot Recommended Floor Plan

Scale : Each square equals one square foot

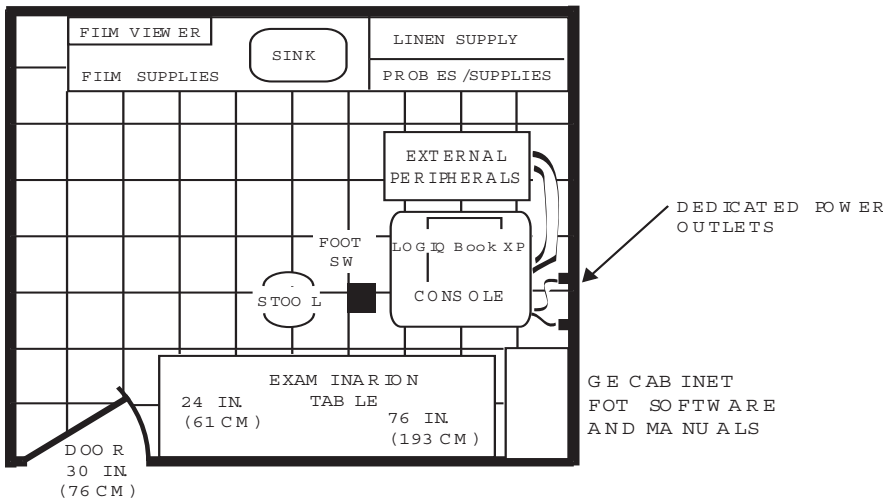

An 8 by 10 foot Minimal Floor Plan

Figure 2-1 RECOMMENDED ULTRASOUND ROOM LAYOUT

2-3-4 Networking Pre-installation Requirements

2-3-4-1 Stand Alone Scanner (without Network Connection)

None.

2-3-4-2 Scanner Connected to Hospital's Network

Supported networks:

Wireless LAN

2-3-4-3 Purpose of DICOM* Network Function

DICOM* services provide the operator with clinically useful features for moving images and patient information over a hospital network. Examples of DICOM* services include the transfer of images to workstations for viewing or transferring images to remote printers. As an added benefit, transferring images in this manner frees up the monitor and peripherals, enabling viewing to be done while scanning continues. With DICOM*, images can be archived, stored, and retrieved faster, easier, and at a lower cost.

2-3-4-4 DICOM* Option Pre-installation Requirements

To configure the LOGIQ Book XP/XP PRO/XP Vet to work with other network connections, the site's network administrator must provide some necessary information.

Information must include:

- A host name, local port number, AE Title, IP address and Net Mask for the LOGIQ Book XP/XP PRO/XP Vet.
- The IP addresses for the default gateway and other routers at the site for ROUTING INFORMATION.
- The host name, IP address, port and AE Title for each device the site wants connected to the LOGIQ Book XP/XP PRO/XP Vet for DICOM* APPLICATION INFORMATION. A field for the make (manufacturer) and the revision of the device, is also included. This information may be useful for solving errors.



NOTICE * This function is not available on Pro American Version.

2-3-4-4 DICOM* Option Pre-installation Requirements (cont'd)

LOGIQ Book Host Name Local Port IP Address . . .

AE Title Net Mask . . .

ROUTING INFORMATION

	Destination IP Addresses				GATEWAY IP Addresses				
					Default				
ROUTER1	<input type="text"/>	<input type="text"/>	<input type="text"/>	<input type="text"/>	<input type="text"/>	<input type="text"/>	<input type="text"/>	<input type="text"/>	<input type="text"/>
ROUTER2	<input type="text"/>	<input type="text"/>	<input type="text"/>	<input type="text"/>	<input type="text"/>	<input type="text"/>	<input type="text"/>	<input type="text"/>	<input type="text"/>
ROUTER3	<input type="text"/>	<input type="text"/>	<input type="text"/>	<input type="text"/>	<input type="text"/>	<input type="text"/>	<input type="text"/>	<input type="text"/>	<input type="text"/>

DICOM APPLICATION INFORMATION

	NAME	MAKE/REVISION	AE TITLE	IP ADDRESSES	PORT
Store 1	<input type="text"/>	<input type="text"/>	<input type="text"/>	<input type="text"/> . <input type="text"/> . <input type="text"/> . <input type="text"/> . <input type="text"/>	<input type="text"/>
Store 2	<input type="text"/>	<input type="text"/>	<input type="text"/>	<input type="text"/> . <input type="text"/> . <input type="text"/> . <input type="text"/> . <input type="text"/>	<input type="text"/>
Store 3	<input type="text"/>	<input type="text"/>	<input type="text"/>	<input type="text"/> . <input type="text"/> . <input type="text"/> . <input type="text"/> . <input type="text"/>	<input type="text"/>
Store 4	<input type="text"/>	<input type="text"/>	<input type="text"/>	<input type="text"/> . <input type="text"/> . <input type="text"/> . <input type="text"/> . <input type="text"/>	<input type="text"/>
Store 5	<input type="text"/>	<input type="text"/>	<input type="text"/>	<input type="text"/> . <input type="text"/> . <input type="text"/> . <input type="text"/> . <input type="text"/>	<input type="text"/>
Store 6	<input type="text"/>	<input type="text"/>	<input type="text"/>	<input type="text"/> . <input type="text"/> . <input type="text"/> . <input type="text"/> . <input type="text"/>	<input type="text"/>
Worklist	<input type="text"/>	<input type="text"/>	<input type="text"/>	<input type="text"/> . <input type="text"/> . <input type="text"/> . <input type="text"/> . <input type="text"/>	<input type="text"/>
Storage Commit	<input type="text"/>	<input type="text"/>	<input type="text"/>	<input type="text"/> . <input type="text"/> . <input type="text"/> . <input type="text"/> . <input type="text"/>	<input type="text"/>
MPPS	<input type="text"/>	<input type="text"/>	<input type="text"/>	<input type="text"/> . <input type="text"/> . <input type="text"/> . <input type="text"/> . <input type="text"/>	<input type="text"/>

Figure 2-2 Worksheet for DICOM Network Information

Chapter 3

Installation

Section 3-1 Overview

3-1-1 Purpose of Chapter 3

This chapter contains information needed to install the unit. Included are references to a procedure that describes how to receive and unpack the equipment and how to file a damage or loss claim. How to prepare the facility and unit of the actual installation, and how to check and test the unit, probes, and external peripherals for electrical safety are included in this procedure. Also included in this section are guidelines for transporting the unit to a new site.

Table 3-12 Contents in Chapter 3

Section	Description	Page Number
3-1	Overview	3-1
3-2	Receiving and Unpacking the Equipment	3-4
3-3	Packing the Equipment	3-7
3-4	Preparing for Installation	3-8
3-5	Completing the Installation	3-9
3-6	System Configuration	3-12
3-7	Software/Option Configuration	3-26
3-8	Connectivity Installation Worksheet	3-27
3-9	Loading Base Image Software	3-28
3-10	Upgrading Application Software	3-30
3-11	Paperwork	3-40

3-1-2 Average Installation Time

Table 3-13 Average Installation Time

Description	Average Installation Time	Comments
Unpacking the scanner	20 minutes	
Scanner wo/options	30 minutes	Dependent on the configuration that is required
DICOM* Option	30 minutes	Dependent on the amount of configuration

 **NOTICE** * This function is not available on Pro American Version.

The LOGIQ Book XP/XP PRO/XP Vet installation and functional checkout will take approximately one hour. LOGIQ Book XP/XP PRO/XP Vet consoles with optional equipment may take slightly longer.

3-1-3 Installation Warnings

- 1.) There are no operator serviceable components. To prevent shock, do not remove any covers or panels. Should problems or malfunctions occur, unplug the power cord. Only qualified service personnel should carry out servicing.

NOTE: For information regarding packing labels, refer to LABELS ON PACKAGE.

- 2.) After being transported, the unit may be very cold or hot. If this is the case, allow the unit to acclimate before you turn it on. It requires one hour for each 2.5°C increment it's temperature is below 10°C or above 40°C.







 **DANGER** Equipment damage possibility. Turning the system on without acclimation after arriving at site may cause the system to be damaged.

Table 3-14 Time for Settlement

°C	60	55	50	45	40	35	30	25	20	15	10	5	0	-5	-10	-15	-20	-25	-30	-35	-40
°F	140	131	122	113	104	95	86	77	68	59	50	41	32	23	14	5	-4	-13	-22	-31	-40
hrs	8	6	4	2	0	0	0	0	0	0	0	2	4	6	8	10	12	14	16	18	20

3-1-4 Safety Reminders

-  **DANGER** **WHEN USING ANY TEST INSTRUMENT THAT IS CAPABLE OF OPENING THE AC GROUND LINE (I.E., METER'S GROUND SWITCH IS OPEN), DON'T TOUCH THE UNIT!**
-  **CAUTION** If the unit is very cold or hot, do not turn on its power until it has had a chance to acclimate to its operating environment.
-  **DANGER** To prevent electrical shock, connect the unit to a properly grounded power outlet. Do not use a three to two prong adapter. This defeats safety grounding.
-  **DANGER** Do not operate this unit unless all board covers are securely in place.
-  **DANGER** **OPERATOR MANUAL(S)**
The User Manual(s) should be fully read and understood before operating the LOGIQ Book XP/XP PRO/XP Vet and kept near the unit for quick reference.
-  **DANGER** **ACOUSTIC OUTPUT HAZARD**
Although the ultrasound energy transmitted from the LOGIQ Book XP/XP PRO/XP Vet probe is within FDA limits, avoid unnecessary exposure. Ultrasound energy can produce heat and mechanical damage

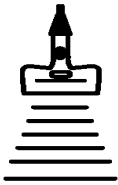

Section 3-2 Receiving and Unpacking the Equipment

When a new system arrives, check that any components are not damaged and are not in short supply. If shipping damage or shortage occurs, contact the address shown in Chapter 1.

- 1.) Cut the four PLASTIC BANDS.
- 2.) Cut the adhesive tape and open top covers of paper carton.

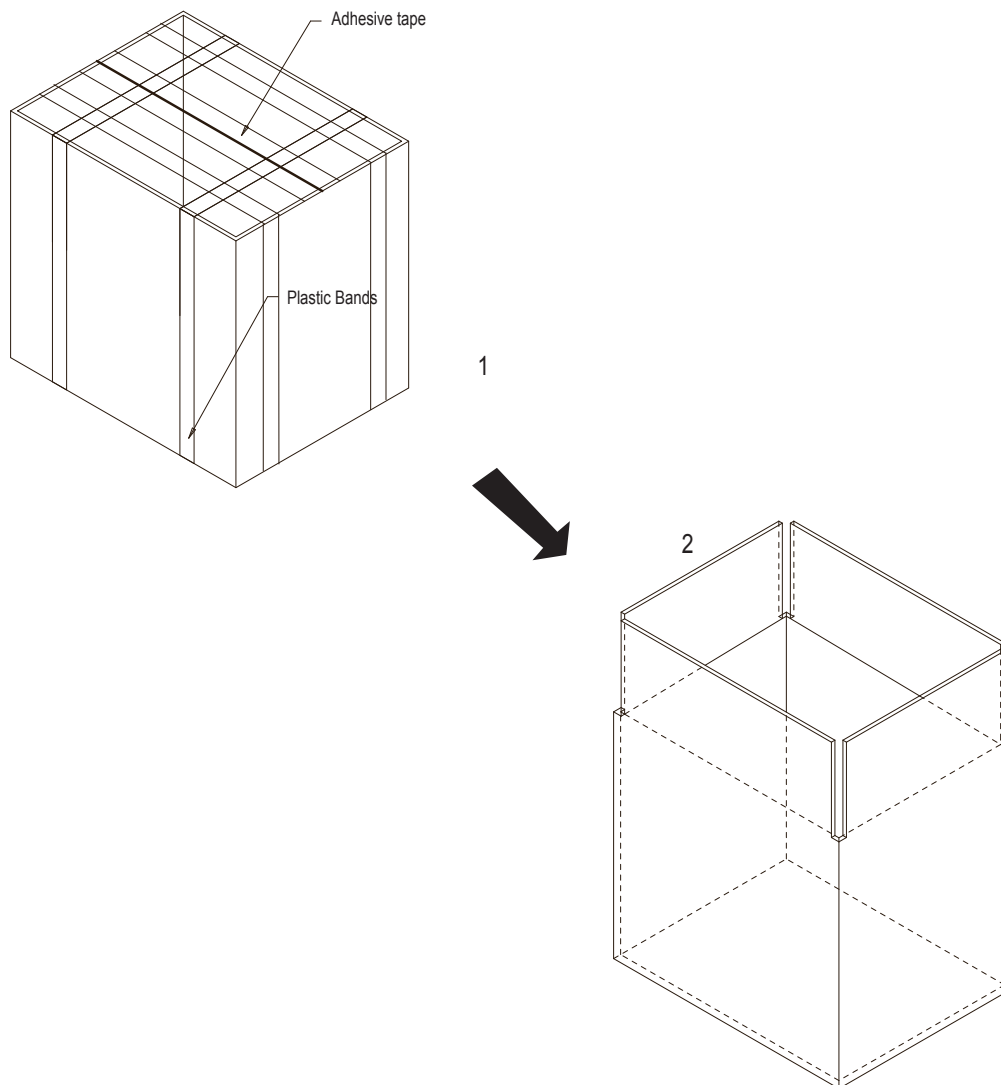

Figure 3-3 Open top covers of paper carton.

Section 3-2 Receiving and Unpacking the Equipment (cont'd)

- 3.) Take out the Paper pad.
- 4.) Take out console together with 2 interleavers.
- 5.) Take out the interleavers beside Accessories Package.
- 6.) Take out Accessories Package..

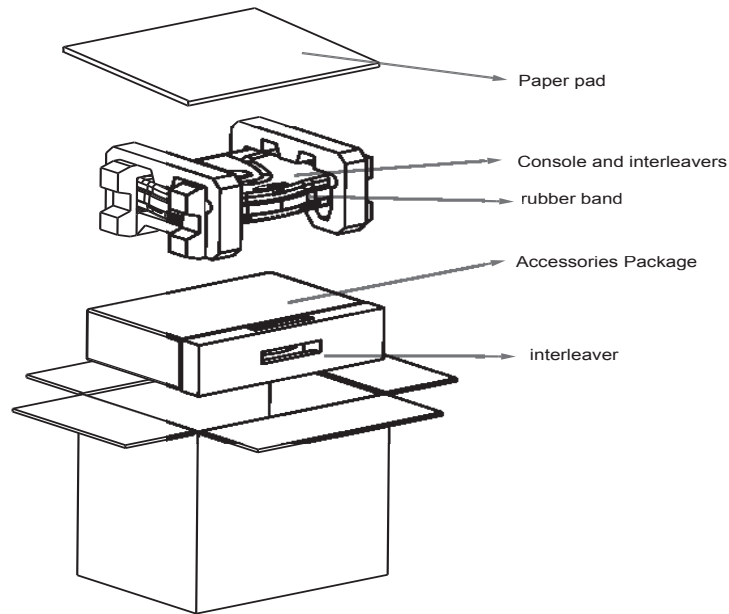

Figure 3-4 Unpacking the equipment



CAUTION Do not lift the unit by the rubber band. Equipment damage may result.

Section 3-2 Receiving and Unpacking the Equipment (cont'd)

- 7.) Remove 2 interleavers.
- 8.) Remove plastic bag.

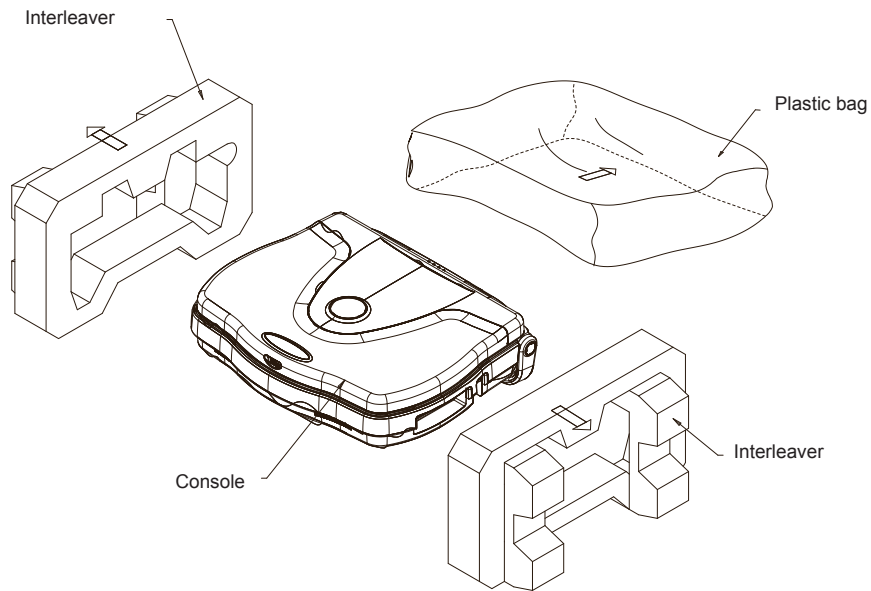

Figure 3-5 Removing interleavers and plastic bag

Section 3-2 Receiving and Unpacking the Equipment (cont'd)

NOTE: Check the shipping container for special instructions. Verify that the container is intact. In some cases a secondary container may be used. If so, ask the carrier for unpacking instructions.

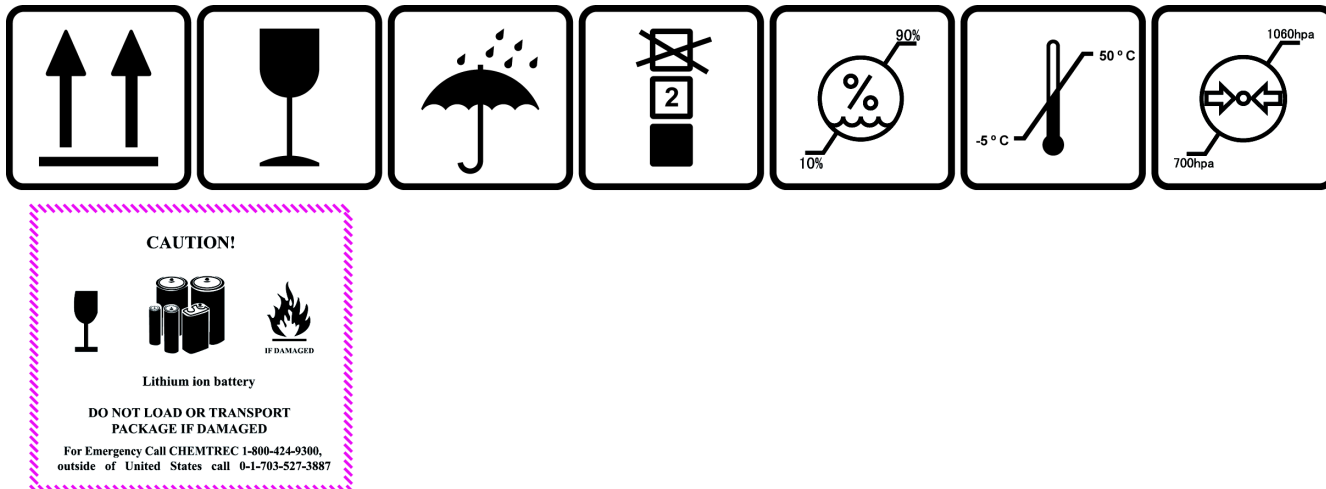

Figure 3-6 Labels on Package

CAUTION Please carefully unpack the system, and do not dispose the package of LOGIQ Book XP/XP PRO/XP Vet, so that it can be reused for service.

3-2-1 Moving into Position

CAUTION Do not lift the unit by the rubber band. Use handle to move system.

CAUTION Equipment Damage Possibility. Lifting the console by holding covers may damage the covers. Do not lift the console by holding any covers.

In general, a single adult can move the LOGIQ Book XP/XP PRO/XP Vet. Before moving, store all loose parts in original accessory box or in back pack. Return probes to original box.

Section 3-3 Packing the Equipment

Please pack LOGIQ Book XP/XP PRO/XP Vet in the reverse order of unpacking.

Section 3-4 Preparing for Installation

3-4-1 Verify Customer Order

Compare items received by the customer to that which is listed on the delivery order. Report any items that are missing, back ordered or damaged.

3-4-2 Physical Inspection

3-4-2-1 System Voltage Settings

- Verify that the scanner is set to the correct voltage. The Voltage settings for the LOGIQ Book XP/XP PRO/XP Vet Scanner is found on a label located on the AC adapter.
- 220-240VAC(China); 100-120VAC(USA/Japan); 220-240VAC(Europe, Latin America)



WARNING *Connecting a LOGIQ Book XP/XP PRO/XP Vet scanner to the wrong voltage level will most likely destroy the scanner.*

3-4-3 EMI Protection

This Unit has been designed to minimize the effects of Electro Magnetic Interference (EMI). Many of the covers, shields, and screws are provided primarily to protect the system from image artifacts caused by this interference. For this reason, it is imperative that all covers and hardware are installed and secured before the unit is put into operation.

Section 3-5 Completing the Installation

3-5-1 Power On / Boot Up

NOTE: After turning off a system, wait at least ten seconds before turning it on again. The system may not be able to boot if power is recycled too quickly.

3-5-1-1 Scanner Power On

Lower the handle. Plug the AC adapter output connector into the system DC input port (located on the system's rear panel) with the arrow side upward. Plug the AC adapter power cord into a grounded, protective earth outlet.

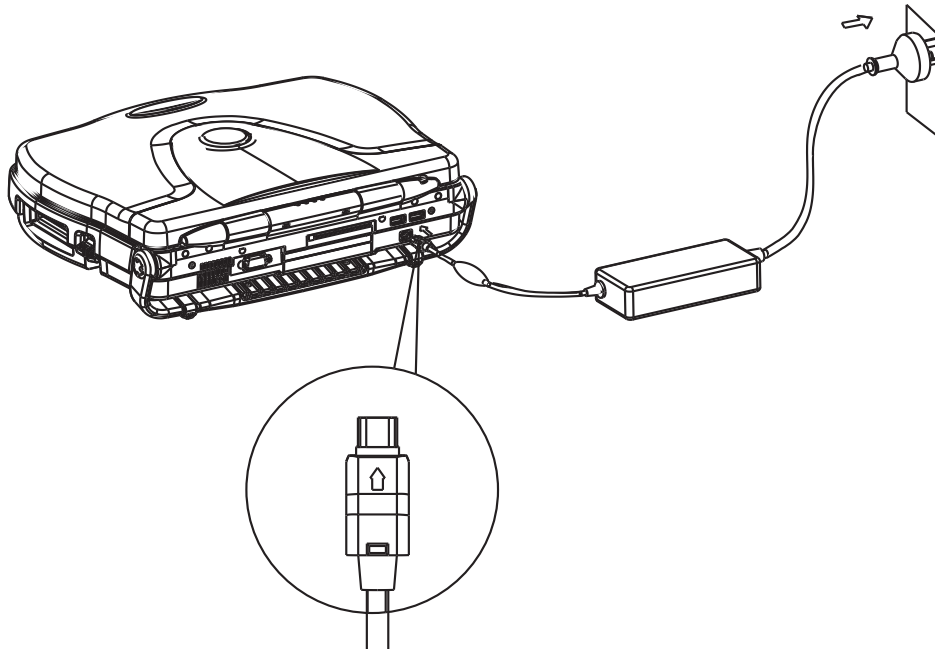

Figure 3-7 connect AC adapter

When power is applied to the scanner, power is distributed to the Cooling Unit, Control Panel, LCD, Peripherals and the Back-end Processor.



CAUTION The system should rest on the handle to allow an air gap to prevent overheating.

3-5-1-2 Turn on the system

Press the **Power On/Off** switch at the front of the system once.

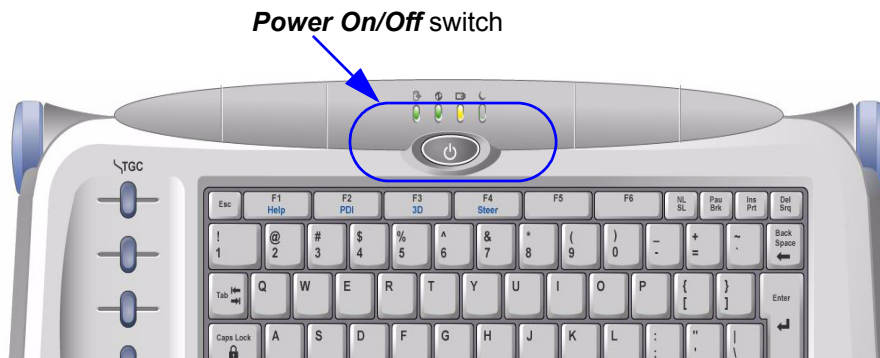

Figure 3-8 Power On/Off Switch

When the **Power On/Off** switch on the Control Panel is pressed once, the Back-end Processor starts and the software code is distributed to initiate the scanner.

No status messages are displayed during this process.

3-5-2 Power Off/ Shutdown

NOTE: After turning off a system, wait at least ten seconds before turning it on again. The system may not be able to boot if power is recycled too quickly.

3-5-2-1 Back-end Processor Power Down

To power down the system:

- 1.) Press the **Power On/Off** switch at the front of the system once.
- 2.) The System-Exit window is displayed.

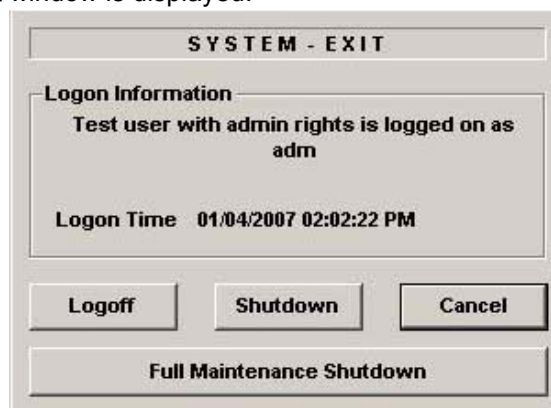

Figure 3-9 System Exit Window

- 3.) Using the Trackball or Select key, select Shutdown.
- 4.) The shutdown process takes a few seconds and is complete when the power status LED is turned off.
- 5.) Disconnect the probes. Clean or disinfect all probes as necessary. Store them in their shipping cases to avoid damage.
- 6.) Close LCD cover.

3-5-2-2 Scanner Shutdown

Disconnect the Mains Power Cable if necessary. *For example:* Relocating the scanner.

3-5-3 Transducer Connection

- 1.) Carefully open the system LCD display, plug the probe connector into the probe port, then lock the probe latch upward.

NOTE: Please ensure that the probe latch is in an unlocked position before you connect the probe to the system.



Figure 3-10 Connect the probe

NOTE: It is not necessary to turn OFF power to connect or disconnect a probe.

Section 3-6 System Configuration

3-6-1 System Specifications

3-6-1-1 Physical Dimensions

The physical dimensions of the LOGIQ Book XP/XP PRO/XP Vet console are summarized in [Figure 3-11](#) on page 3-12 .

Table 3-15 Physical Dimensions of LOGIQ Book XP/XP PRO/XP Vet

Height	Width	Depth	Unit
78-99.5	350	280-320	mm
3.07-3.92	13.78	11-12.6	inches

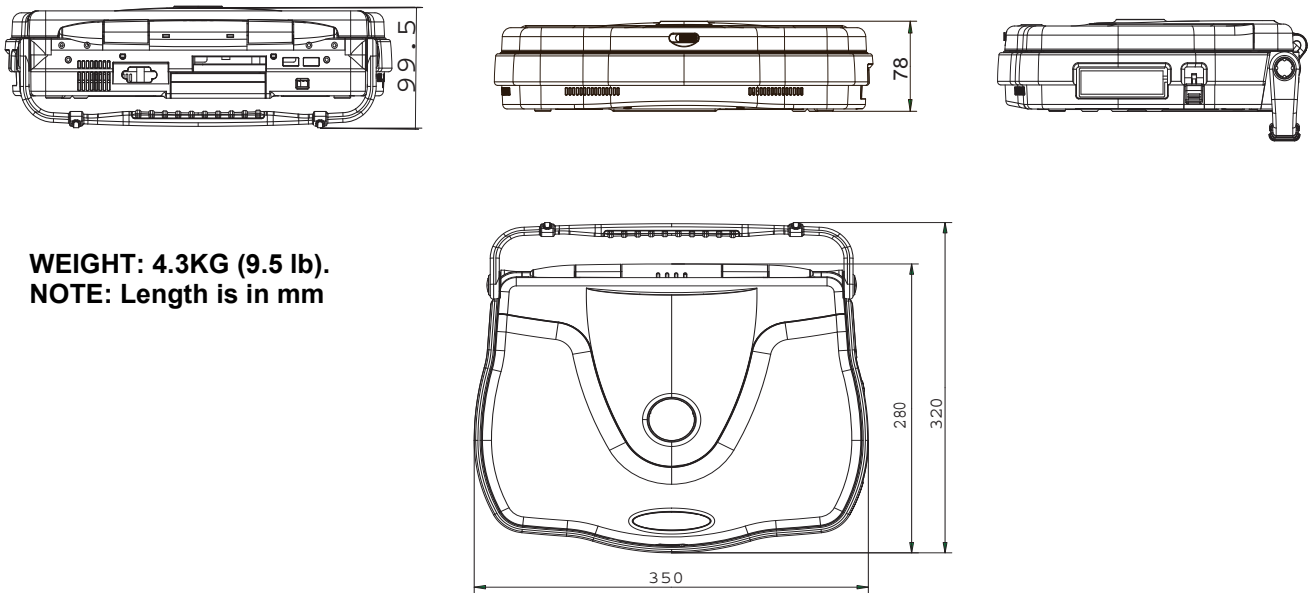

WEIGHT: 4.3KG (9.5 lb).
NOTE: Length is in mm

Figure 3-11 Overall Dimensions

3-6-2 Electrical Specifications

Table 3-16 Electrical Specifications for LOGIQ Book XP/XP PRO/XP Vet

Adapter	Voltage	Tolerances	Current	Frequency
ADM-9020M-GE	100-240 VAC	+/-10%	1.08-0.45 A	50/60Hz

3-6-3 Approved peripherals

Table 3-17 Approved peripherals

Device	Manufacturer	Model	Interface
B/W Printer	SONY	UP-D897MD	USB
B/W Printer	Mitsubishi	P95D	USB
Digital Color Printer	SONY	UP-D23MD	USB
Digital Color Printer	SONY	UP-D25MD	USB
Deskjet Color Printer	HP	HP470	USB
Officejet Color Printer	HP	HP K5400	USB
Officejet Color Printer	HP	HP K8600	USB
Officejet Color Printer	HP	HP 100 Mobile	USB
USB DVD-RW	LITEON	LITEON DX-20A4P	USB
USB DVD-RW	LITEON	LITEON Model eHAU 120	USB
USB DVD-RW	LITEON	LITEON Model eHAU 324	USB
USB DVD-RW	Plextor	PX-L890UE	USB
USB DVD-RW	LITEON	LITEON eSAU108 DVDRW	USB
USB DVD-RW	LITEON	LITEON eUAU108 DVDRW	USB
Wireless LAN Adapter (Not available on LOGIQ Book XP PRO)	Cisco	LDK10250	PCMCIA
Network Adapter (Not available on LOGIQ Book XP PRO)	Netgear	P/N:FA511	PCMCIA
USB Lamp	KENSINGTON	FlyLight	USB
VCR	Sony	SVO-9500MD/MDP	
Video Adapter	Focus	Tview Micro-NTSC/PAL	USB & SVGA
Footswitch	Whanam	FSU2001	USB
Footswitch	Whanam	FSU1000	USB
USB Memory	Sandisk	Sandisk 2G	USB
USB Memory	Sandisk	Sandisk 4G	USB
USB HUB	PENGHONG	PH-USB500	USB
USB HUB	PENGHONG	HE 420GE	USB
ECG	NORAV	ECG-USB1	USB

NOTE: See each option installation instructions for installation and connection procedures.

 **WARNING** Wire LAN card(FA511) must be worked with patient isolation box (P/N: EP200132), for details, please refer to option manual.

3-6-3-1 Reference other peripherals and options

- Footswitch

3-6-4 Connecting Cables

WARNING Equipment damage possibility. Be sure to use the following recommended connecting cables to connect recording devices and a network with LOGIQ Book XP/XP PRO/XP Vet console.

Table 3-18 List of Connecting Cables

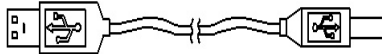
Name	Part No.	Figure	NOTE
USB Cable	5135661		For USB Printer & USB CD-RW

3-6-5 Peripherals/Accessories Connector Panel

LOGIQ Book XP/XP PRO/XP Vet peripherals and accessories can be properly connected using the rear connector panel.

3-6-5-1 Rear Panel Connector

Located on the rear panel are video input and output connectors, audio input and output, camera expose connectors, footswitch connector, power connector, and control connections for printer, and service tools.

3-6-5-1 Rear Panel Connector (cont'd)

This section indicates the pin assignment for each connector.

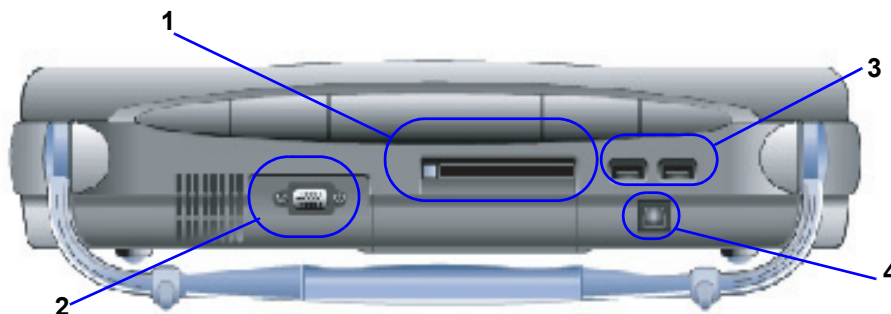

Figure 3-12 Rear Connector Panel

- 1.) PCMCIA Port for PC Card
- 2.) SVGA Output (CRT monitor option is not supported)
- 3.) Two interchangeable USB Port (Digital Printer, CD-RW and/or Footswitch, etc)
- 4.) Port for DC input (AC Adapter)



NOTICE The USB devices should be connected to LOGIQ Book XP/XP PRO/XP Vet first, power on USB devices before turning LOGIQ Book XP/XP PRO/XP Vet to work.

NOTE: After User insert the PC Card into the PCMCIA Port, a “Beep” of buzzer will be heard, which means the Card works properly, otherwise, please pull out the Card and insert again.

NOTE: Each outer (case) ground line of peripheral/accessory connectors are protectively grounded. Signal ground lines are not isolated.

3-6-5-1 Rear Panel Connector (cont'd)

1. Pin Assignment of DC/DC input

Connector: 3 Pin, Female

Table 3-19 Pin Assignments of DC/DC input

Pin No.	Signal	Pin No.	Signal
1	+	3	-
2	NC		

2. Pin Assignment of USB

Table 3-20 Pin assignment of USB1

Pin No.	Signal	Pin No.	Signal
1	+5VDC	3	DATA+
2	DATA-	4	GND

Table 3-21 Pin assignment of USB2

Pin No.	Signal	Pin No.	Signal
1	+5VDC	3	DATA+
2	DATA-	4	GND

3. Pin assignment of RS232C for external VGA

Connector: D-SUB, 15Pin, Female

Table 3-22 Pin Assignments of RS232C for External VGA

Pin No.	Signal	Pin No.	Signal
1	RED	9	N/A
2	GREEN	10	SGND
3	BLUE	11	N/A
4	N/A	12	N/A
5	GND	13	HSYNC
6	RGND	14	VSYNC
7	GGND	15	N/A
8	BGND	16	

3-6-5-1 Rear Panel Connector (cont'd)

4. Pin Assignment of PCMC

Table 3-23 Pin Assignments of PCMCIA

Pin No.	Signal	Pin No.	Signal
1	DGND	35	DGND
2	BCDATA3	36	BCD1#
3	BCDATA4	37	BCDATA11
4	BCDATA5	38	BCDATA12
5	BCDATA6	39	BCDATA13
6	BCDATA7	40	BCDATA14
7	BCE1#	41	BCDATA15
8	BCADR10	42	BCE2#
9	BOE#	43	BVS1#
10	BCADR11	44	BIORD#
11	BCADR9	45	BIOWR#
12	BCADR8	46	BCADR17
13	BCADR13	47	BCADR18
14	BCADR14	48	BCADR19
15	BWE_C#	49	BCADR20
16	BRDY_IREO#	50	BCADR21
17	PPCMVCCB	51	PPCMVCCB
18	PPCMVPPB	52	PPCMVPPB
19	BCADR15	53	BCADR22
20	BCADR16	54	BCADR23
21	BCADR12	55	BCADR24
22	BCADR7	56	BCADR25
23	BCADR6	57	BVC2#
24	BCADR5	58	BRESET
25	BCADR4	59	BWAIT#
26	BCADR3	60	BINPACK#
27	BCADR2	61	BREG#
28	BCADR1	62	BBCD2
29	BCADR0	63	BBCD1

Table 3-23 Pin Assignments of PCMCIA

Pin No.	Signal	Pin No.	Signal
30	BCDATA0	64	BCDATA8
31	BCDATA1	65	BCDATA9
32	BCDATA2	66	BCDATA10
33	BIOCS16#	67	BCD2#
34	DGND	68	DGND

3-6-5-2 Connect peripherals

A.) Connect B/W printer to the system.

B/W Printer can be properly connected using USB Port1 or USB Port 2(Figure 3-13 on page 3-18).



Figure 3-13 Connect B/W printer to the system

3-6-5-2 Connect peripherals (cont'd)

B.) Connect UP-D23MD color printer to the system.

UP-D23MD Color Printer can be properly connected using USB Port 1 or USB Port 2 (Figure 3-14 on page 3-19).



Figure 3-14 Connect digital color printer to the system



NOTICE HP470 Deskjet Color Printer and HP K5400 Officejet Color Printer must connect with PIT (Printer Isolation Transformer) when being used.

3-6-5-2 Connect peripherals (cont'd)

C.) Connect CD-RW to the system.

CD-RW can be properly connected using USB Port1 or USB Port2.



Figure 3-15 Connect CD-RW to the system

Iomega CD-RW drive recommended media list

Media issues are common throughout the CD-RW drive industry. Because CD media vendors often change disc suppliers, quality levels may change due to manufacturing differences. This means that you may encounter CD creation problems with media that may have worked successfully before. Overall system configuration and other factors may also affect the success of creating a CD.

The following media types have been tested. Iomega highly recommends that you use the media types on this list when creating your CDs.

Not all brands of media have been tested and, therefore, you may encounter success with other brands not listed. This list will be updated as other media is tested and approved.

Table 3-24 Iomega CD-RW drive recommended media list

Brand Name	Type	Product Code	Speed
Acer	CDR80	Acer Media	40x-1x
Digital Research	CDR80	DRCDR3250	32x-1x
Fuji Photo Film	CDR74	CD-R74C	24x-1x
Fuji Photo Film	CDR74	CD-R650D	24x-1x
Fuji Photo Film	CDR80	CD-R700D	24x-1x
Hi-Val	CDR80	CDR80 16x	24x-1x
Imation	CDR80	CDR80 16x	24x-1x
Iomega Verbatim	CDR	CD-R74	32x-1x
Kodak	CDR	CDR Ultima	16x-1x
Kodak	CDR	CDR Gold Ultima	16x-1x

Table 3-24 Iomega CD-RW drive recommended media list

Brand Name	Type	Product Code	Speed
Mitsui	CDR	CDR74	32x-1x
Mitsui	CDR	CDR80	32x-1x
Mitsubishi Chemical	Ultra CDRW	-	24x
Mitsubishi Chemical	HS CDRW	RW74EU1	12x/10x/8x/4x
Mitsubishi Chemical	CDRW	RW74Q1	4x/2x
Mitsubishi Chemical	CDRW	RW74U1P	4x/2x
Ricoh	CDR74	Type 74R-SG	24x-1x
Ricoh	CDR74	Type 74-SFSGH2	24x-1x
Ricoh	CDR80	CD-R Type 80	24x-1x
Ricoh	HS CDRW	CDRW 74 10x	12x/10x/8x/4x
Ricoh	CDRW	74R-AZ2	4x/2x
Ricoh	CDRW	74R-AZ2M3	4x/2x
Ricoh	CDRW	74R-AZ2M4	4x/2x
Ricoh	CDRW	74R-AZ	2x
Ricoh	CDRW	74R-AZAM	2x
Samsung	CDR74	Premium CDR-74	32x-1x
Sentinel	CDR74	CDR74 Hyperspeed	16x-1x
TDK	48x	-	48x-1x
TDK	CDR74	CD-R74S	24x-1x
TDK	CDR74	CD-R74A	24x-1x
TDK	CDR80	CD-R80A	24x-1x
TDK	CDRW	CD-RW74	4x/2x
Verbatim	CDR	DataLifePlus CD-R 700	48x-1x
Verbatim	CDR	DataLifePlus CD-R 650	24x-1x
Verbatim		DataLifePlus CD-RW 650	4x/2x
Yamaha	CDRW	CD-RW74M4	4x/2x

3-6-5-2 Connect peripherals (cont'd)

D.) Connect Footswitch to the system.

Footswitch can be properly connected using USB Port1 or USB Port2.



Figure 3-16 Connect Footswitch to the system

E.) Connect Wireless LAN Card to the system. (Not available on LOGIQ Book XP PRO)

Wireless LAN Card can be properly connected using Signal Port for Card.

Wireless
LAN Card



Figure 3-17 Connect Wireless LAN Card to the system

F.) Connect the CRT to the system.

CRT can be properly connected using the SVGA output.

3-6-5-2 Connect peripherals (cont'd)

- G.) Connect the USB Lamp to the system. The USB Lamp can be properly connected using USB port 1 or 2.

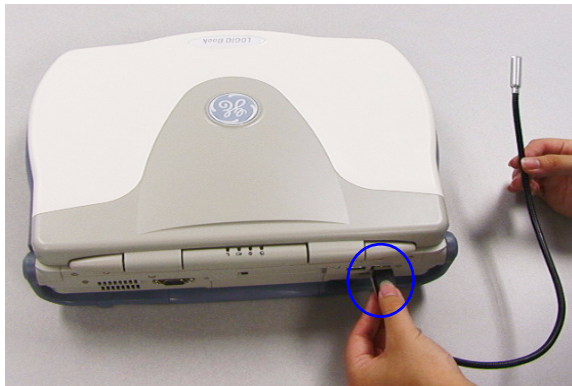

Figure 3-18 USB Lamp connection

- H.) Connect the Video Adapter and VCR to the system. The Video Adapter can be properly connected using SVGA output and USB port 1 or 2.

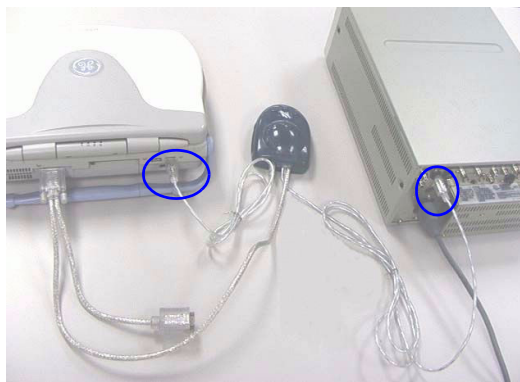

Figure 3-19 Video Adapter and VCR Connection

- I.) Connect the USB Memory to the system. The USB Memory can be properly connected using USB port 1 or 2.



Figure 3-20 USB Memory Connection

3-6-5-2 Connect peripherals (cont'd)

J.) Connect the ECG to the system. ECG can be properly connected using USB port 1 or 2.



Figure 3-21 ECG

NOTE: *Please refer to the operation manual of each peripheral for information needed by the user to operate the system safely.*

For detailed installation information, please refer to the LOGIQ Book XP/XP PRO/XP Vet Peripheral Installation Instruction manual.

3-6-6 Available Probes

See in specification in the LOGIQ Book XP/XP PRO/XP Vet User Reference Manual for Probes and intended use.

Table 3-25 List of Probes on LOGIQ Book XP/XP PRO

Probe Name	Material of Headshell	Area of Using	TYPE	Catalog Number	Part Number
3C-RS	NORYL	GENERAL PURPOSE	CONVEX	H40402LL	2290776
E8C-RS	VALOX	TRANSVAGINAL TRANSRECTAL	MICRO-CONVEX	H40402LN	2290777
8C-RS	VALOX	VETERINARY PEDIATRIC NEONATAL	MICRO-CONVEX	H40402LS	2354971
i12L-RS	ABS (GE)	INTRAOPERATIVE SMALL PARTS VASCULAR PEDIATRICS	LINEAR	H40402LW	2377942
8L-RS	VALOX	SMALL PARTS PERIPHERAL VASCULAR	LINEAR	H40402LT	2376127
3S-RS**	VALOX	CARDIOLOGY TRANSVAGINAL ABDOMEN	SECTOR	H4000PD	2355686
i739-RS*	NORYL	INTRAOPERATIVE SMALL PARTS PERIPHERAL VASCULAR	LINEAR	H40402LJ	2404995
T739-RS	NORYL	INTRAOPERATIVE SMALL PARTS PERIPHERAL VASCULAR	LINEAR	H40412LP	2404999



NOTICE * i739-RS are not available on LOGIQ Book XP PRO.



NOTICE ** Availability of 3S-RS depends on the configuration of the LOGIQ Book XP PRO

3-6-6 Available Probes (cont'd)

Table 3-26 List of Probes on LOGIQ Book XP Vet

Probe Name	Material of Headshell	Area of Using	TYPE	Catalog Number	Part Number
3C-RS	NORYL	GENERAL PURPOSE	CONVEX	H41562LJ	5134641
E8C-RS	VALOX	TRANSVAGINAL TRANSRECTAL	MICRO-CONVEX	H41562LL	5134643
8C-RS	VALOX	VETERINARY PEDIATRIC NEONATAL	MICRO-CONVEX	H41562LK	5134642
i12L-RS	ABS (GE)	INTRAOPERATIVE SMALL PARTS VASCULAR PEDIATRICS	LINEAR	H41562LN	5134645
8L-RS	VALOX	SMALL PARTS PERIPHERAL VASCULAR	LINEAR	H41562LM	5134644
3S-RS	VALOX	CARDIOLOGY TRANSVAGINAL ABDOMEN	SECTOR	H41562LR	5134647
i739-RS LC	NORYL	INTRAOPERATIVE SMALL PARTS PERIPHERAL VASCULAR	LINEAR	H41482LS	5136420
T739-RS	NORYL	INTRAOPERATIVE SMALL PARTS PERIPHERAL VASCULAR	LINEAR	H41562LP	5134646

**Section 3-7
Software/Option Configuration**

Refer to the LOGIQ Book XP/XP PRO/XP Vet Basic User Manual, Chapter 16, Customizing Your System for information on configuring items like Hospital, Department, Language, Units (of measure), Date, Time and Date Format.

For information on configuring Software Options, Refer to the LOGIQ Book XP/XP PRO/XP Vet Basic User Manual, Chapter 16, Customizing Your System.

For information on configuring DICOM* Connectivity, Refer to the LOGIQ Book XP/XP PRO/XP Vet Basic User Manual, Chapter 16, Customizing Your System.



NOTICE * This function is is not available on Pro American Version.

Section 3-8 Connectivity Installation Worksheet

Site System Information

Site: Floor: Comments:

Dept: Room:

LOGIQ SN: Type: REV:

CONTACT INFORMATION

Name	Title	Phone	E-Mail Address

TCP/IP Settings

Name - AE Title:

<p>IP Settings</p> <p>IP Address: <input type="text"/></p> <p>Subnet Mask: <input type="text"/></p> <p>Default Gateway: <input type="text"/></p>	<p>Remote Archive Setup</p> <p>Remote Archive IP: <input type="text"/></p> <p>Remote Archive Name: <input type="text"/></p>
---	--

Services (Destination Devices)

	Device Type	Manufacturer	Name	IP Address	Port	AE Title
1						
2						
3						
4						
5						
6						
7						
8						
9						
10						
11						
12						

Section 3-9 Loading Base Image Software

NOTE: While it is believed to be unnecessary, It would not hurt to disconnect the system from the network and remove all transducers.

- 1.) Insert the disk labeled “Base System Software Load Image” into the CDROM drive.
- 2.) Properly turn off the scanner by momentarily pressing the *Power On/Off* Switch. Select Shutdown from the System Exit menu. Wait for the *Power On/Off* Switch to turn amber.
- 3.) If the system will not shutdown normally, hold down the *Power On/Off* Switch until the light turns from green to amber.

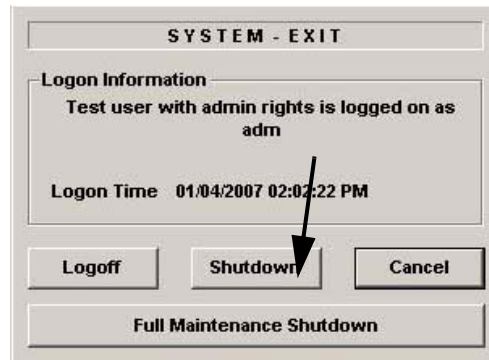

Figure 3-22 Shutdown Dialog Box

- 4.) Turn on the scanner. system will detect the CDRW automatically as shown in [Figure 3-23 on page 3-28](#) .



Figure 3-23 System Update

- 5.) Press any key on the Keyboard to continue the steps.
- 6.) Press any key to continue when below message display as shown in [Figure 3-24 on page 3-29](#) .

Section 3-9 Loading Base Image Software (cont'd)

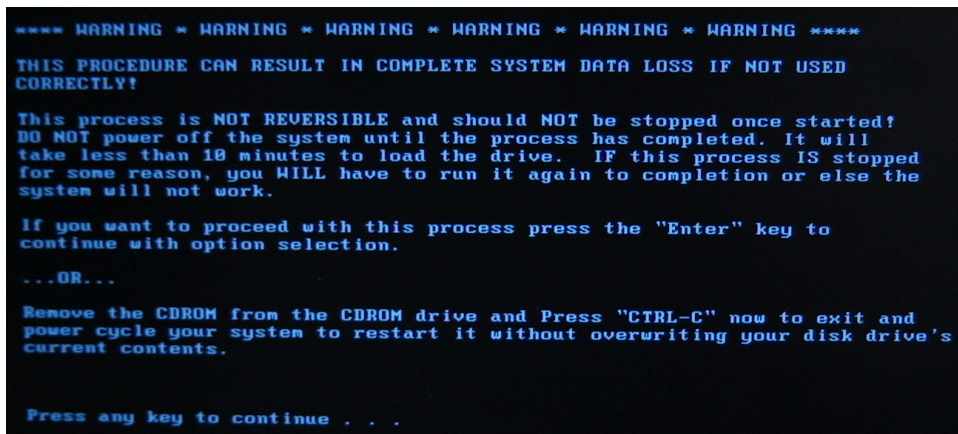

Figure 3-24 Update message

7.) System CD will be loaded as shown in [Figure 3-25 on page 3-29](#) .

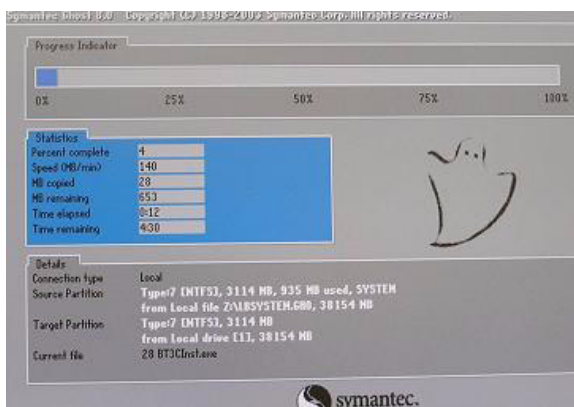

Figure 3-25 System CD loading

8.) After finish updating system CD, take out "System Software CD" from CD-RW, prepare to upgrade "Application Software". Refer to [Figure 3-26 on page 3-29](#)

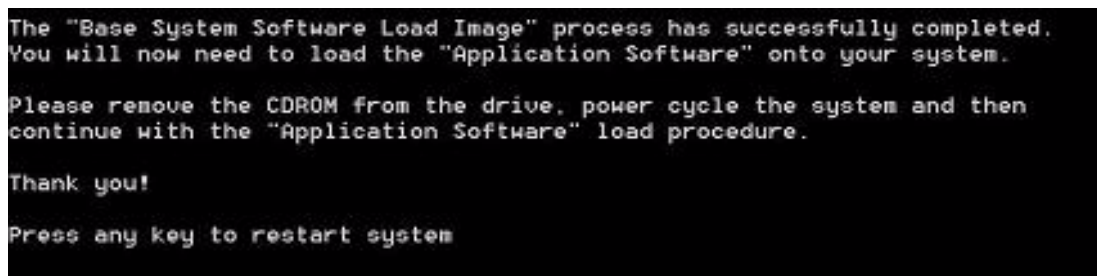



Figure 3-26

Section 3-10 Upgrading Application Software

 **WARNING** *While the software install procedure is designed to preserve data, you should save any patient data, images, system setups to a CD-RW or hardcopy.*

- 1.) Disconnect the system from the network.
- 2.) Place the "Application Software" CD-ROM into the CD-ROM drive.
- 3.) Power Down the scanner.
- 4.) Power up the scanner. Wait for a dialog box like the one in [Figure 3-27 on page 3-30](#) .

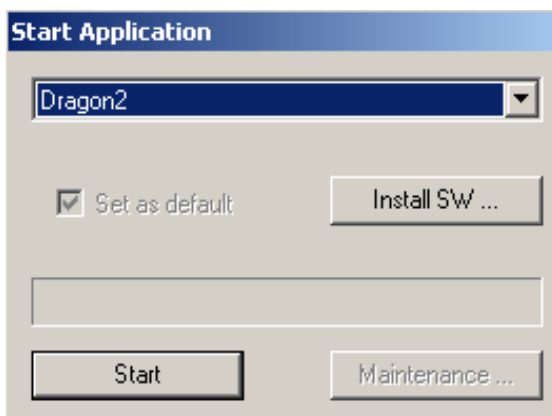

Figure 3-27 Start Application Window

- 5.) Select INSTALL SW
- 6.) There will be two dialog boxes popping up warning you that you are about to install new software as shown in [Figure 3-28 on page 3-30](#) . In both cases click OK.

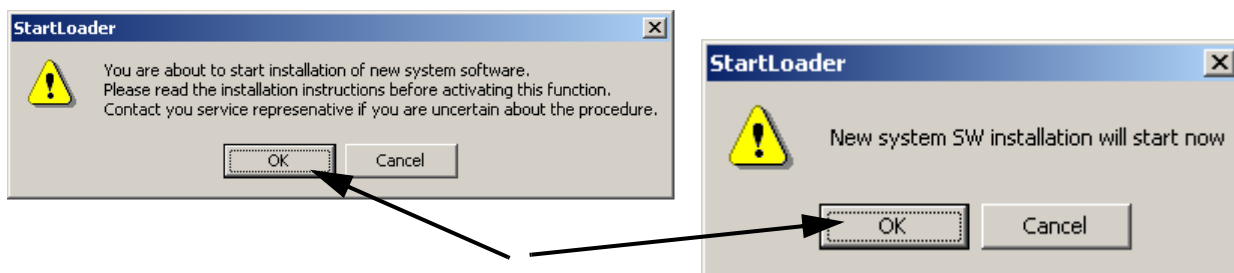

Figure 3-28 Start Loader Dialog Boxes

- 7.) Now you just have to wait till the Software loads (Approximately for 10 minutes).
- 8.) When the process has completed, the window will turn dark and you will see the following message in [Figure 3-29 on page 3-31](#) .

Section 3-10 Upgrading Application Software (cont'd)

* The system will shutdown in 5 seconds *

Figure 3-29 Software Load Complete

- 9.) When it completes loading the system will reboot.
- 10.) Remove the CD from the drive.

If possible, while the system is rebooting remove the CD from the drive. If you didn't do that don't worry you will get a dialog box like the one shown in [Figure 3-30 on page 3-31](#) .

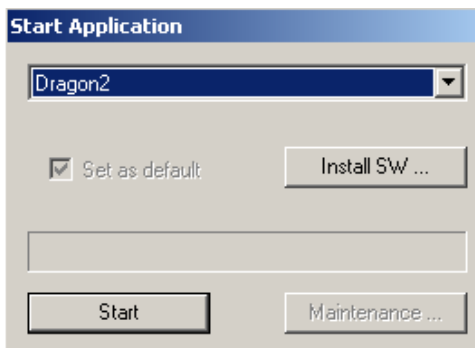

Figure 3-30 Start Software

- 11.) REMOVE the Applications CD
- 12.) From the Start Applications dialog box, select START.
- 13.) Select UPGRADE button to upgrade the FPGA while the following message box appears by pressing the unmarked key of the trackball.

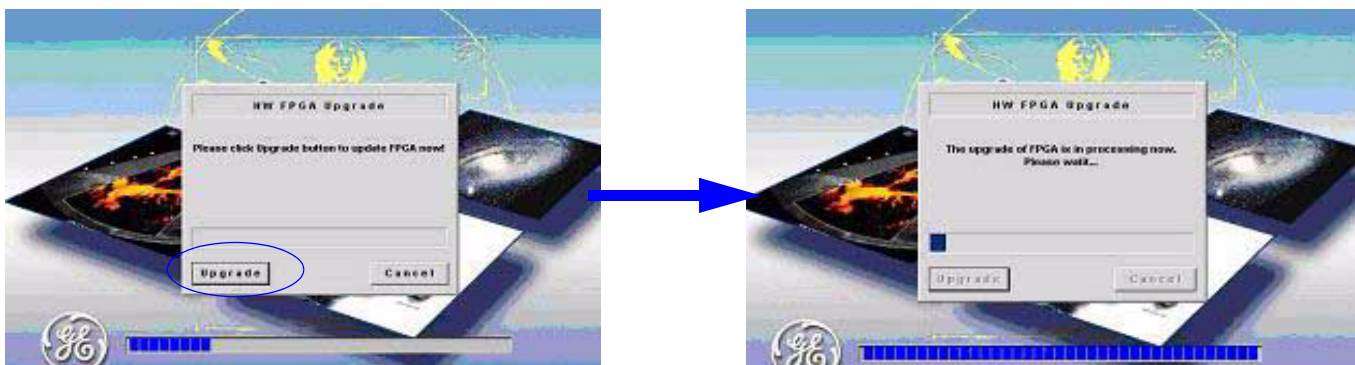

Figure 3-31 Upgrade FPGA

Section 3-10 Upgrading Application Software (cont'd)

14.) Click on the SHUT DOWN button to shut down the system after FPGA upgrade completing.

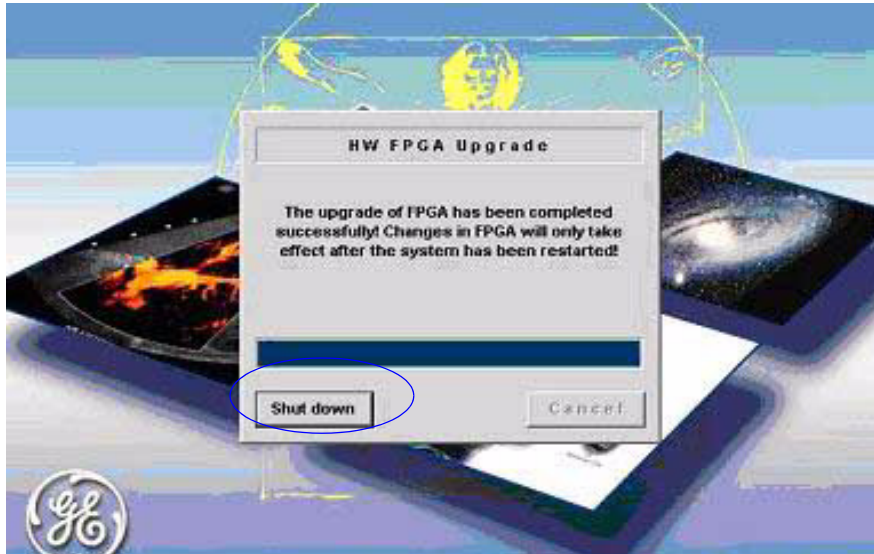

Figure 3-32 FPGA Upgrade

3-10-1 Functional Check-out

- 1.) Power on LOGIQ Book XP/XP PRO/XP Vet scanner and wait until system booting to main screen.
- 2.) Press UTILITY key on control panel.
- 3.) Choose the ABOUT button on the right.

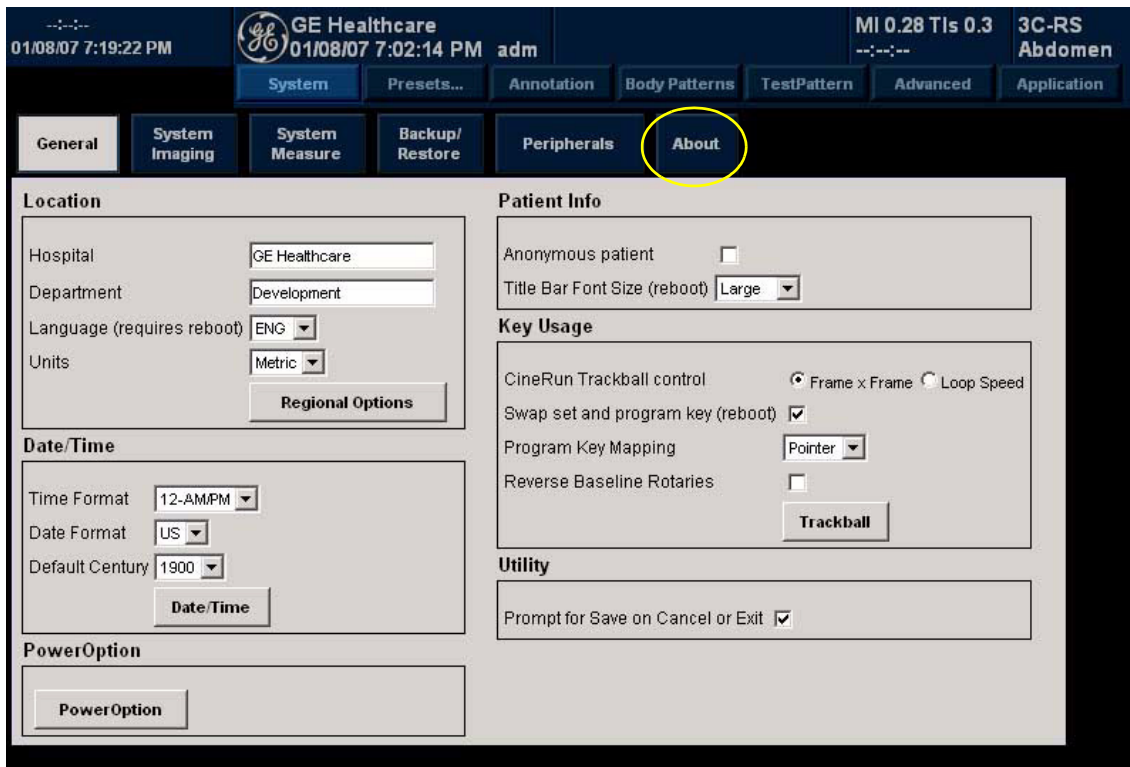

Figure 3-33 General sheet

- 4.) Check whether "Software version" is the right version for use.



Figure 3-34 Software Version Information

NOTE: The software version information displayed in [Figure 3-34 on page 3-33](#) does not necessarily reflect the software version you install on your ultrasound system. The real software version will display on your ultrasound system after you have completed loading the system software.

3-10-2 Option Key Update

NOTE: After the system software loading completion, please input option key and check the option strings to ensure that the options are activated and working.

NOTE: Option key is required to be input when the system is powered on after software loading completion.

- 1.) Power on the system.
- 2.) Input series number of the system and select "OK".
- 3.) Input option key according to SW Option Key label.
- 4.) Press "OK" and the system enters scanning mode.
- 5.) Refer to the process as below to verify if the options are activated and working.

Select **Utility** -> **Advanced** -> **Admin** -> **System Admin**, then check "option" list. If the option is enable or permanent, it means the option function is available; if the option is disabled, it means the function is invalid.

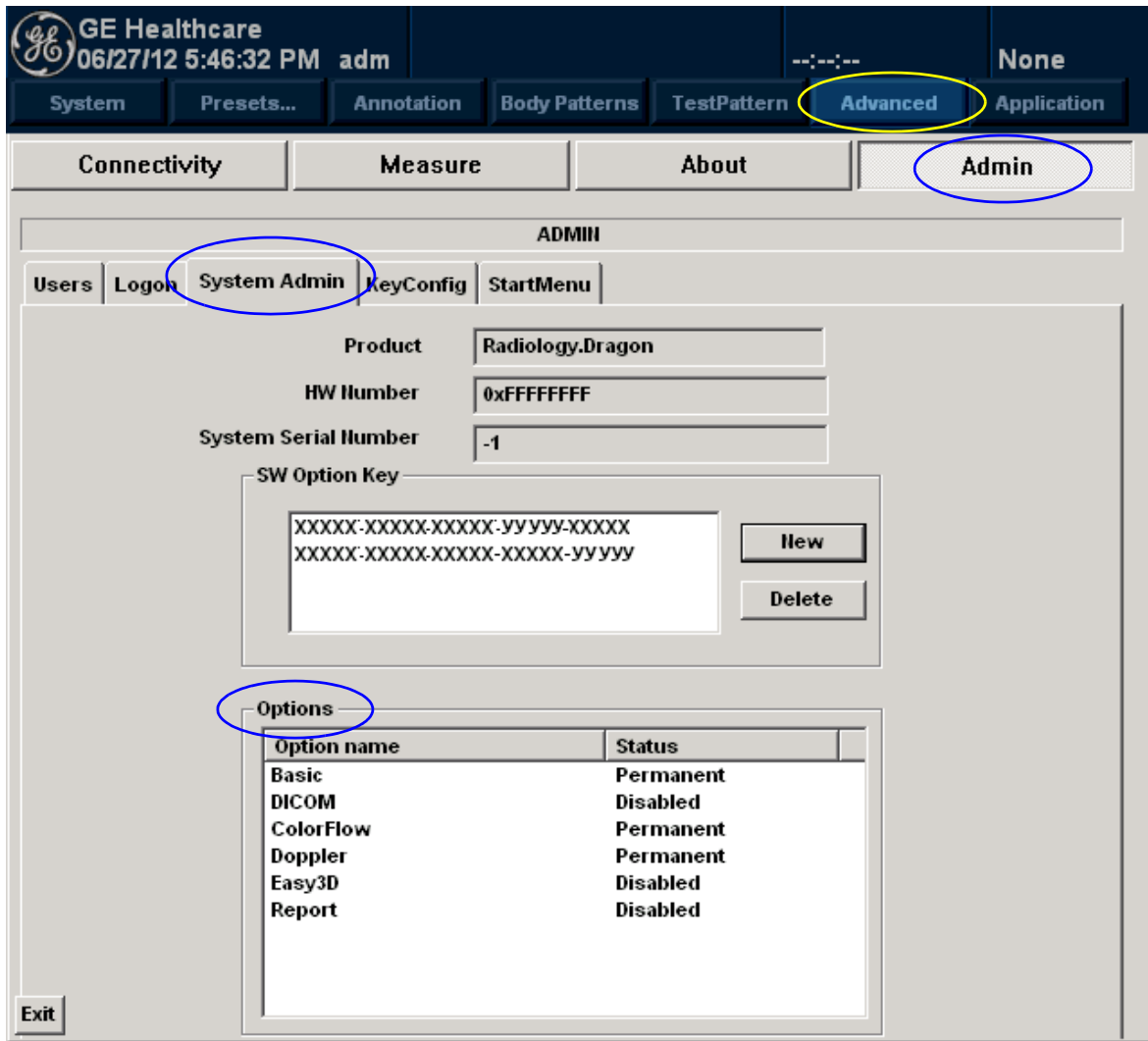

Figure 3-35 Option key screen

3-10-2 Option Key Update (cont'd)

- 6.) Some of the options are in disabled status. That means the function of these options is not available. To activate these options, the user need to add new option key. Please select "New".

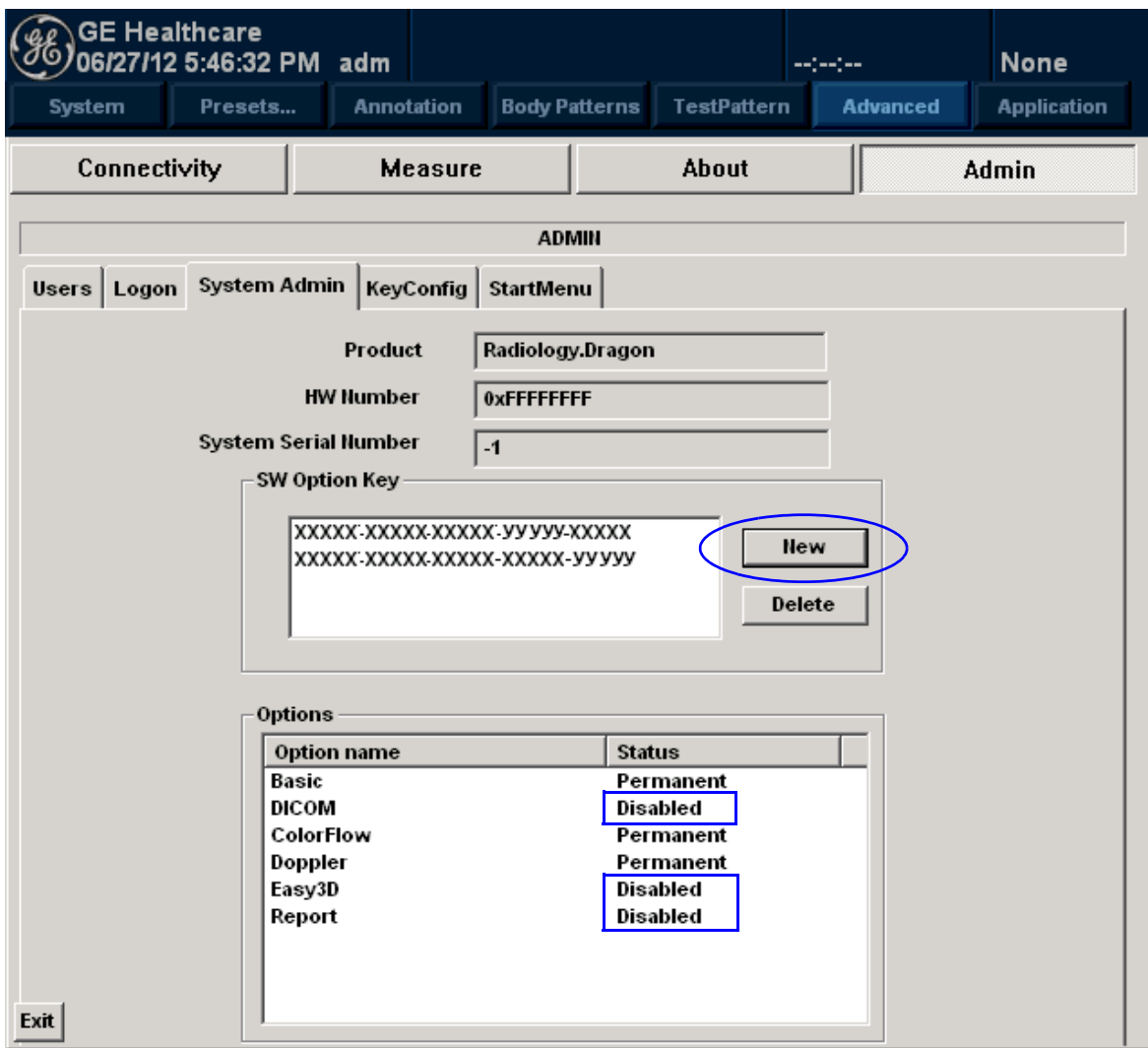

Figure 3-36 Add new option key

- 7.) The system pops up a dialogue box for the user to input option key. Input option key according to SW Option Key label. Select "OK".

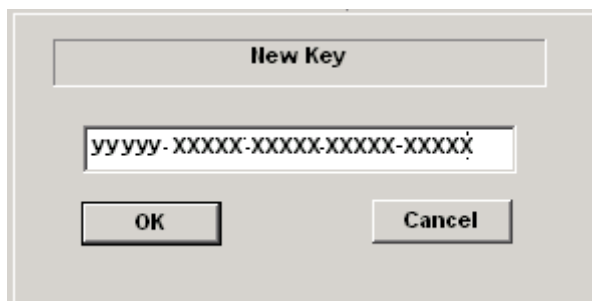

Figure 3-37 Input new option key

3-10-2 Option Key Update (cont'd)

- 8.) The option key is displayed in the **SW Option Key** list. The status of the options become **Valid**. That means the function of these options is available.

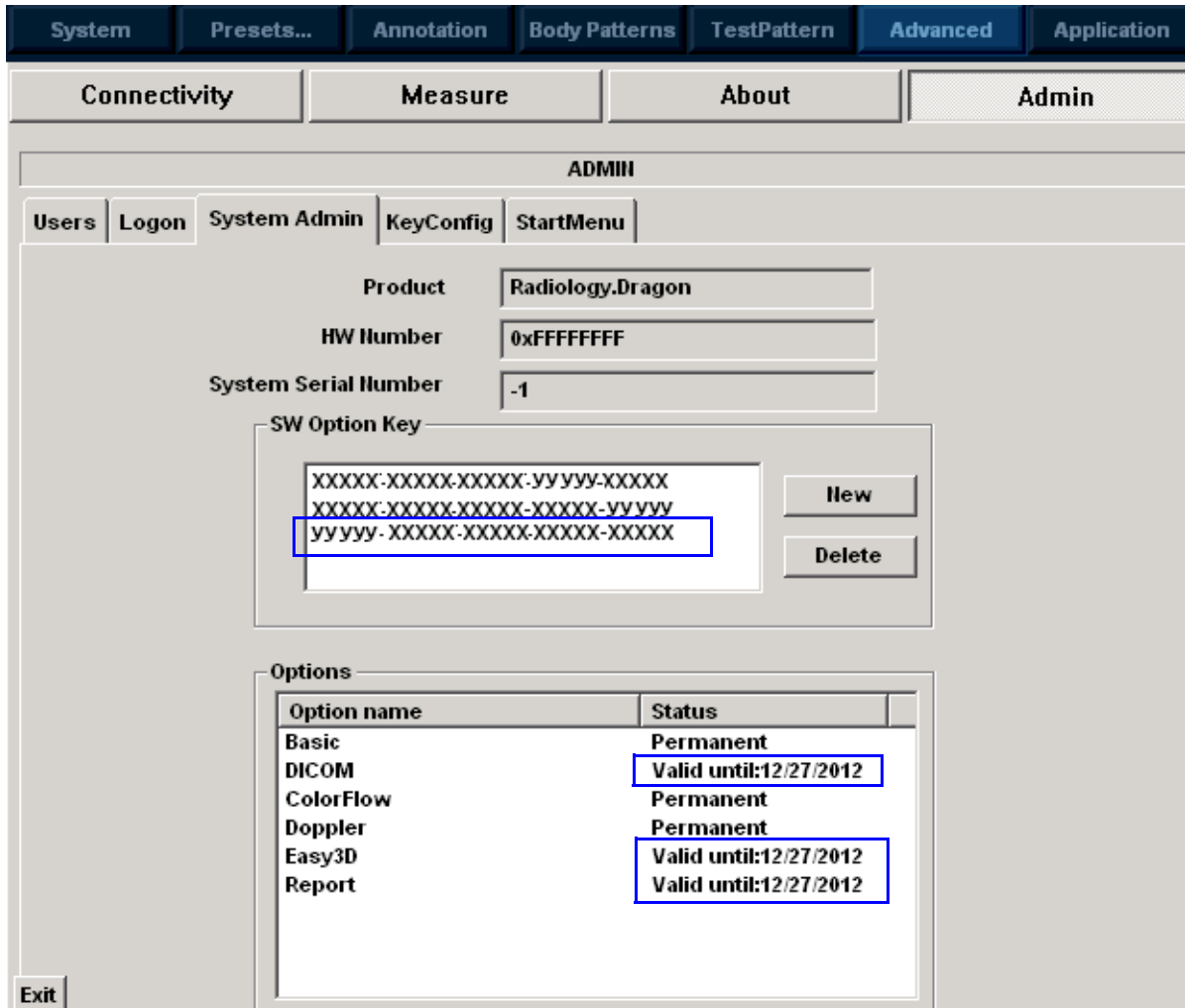
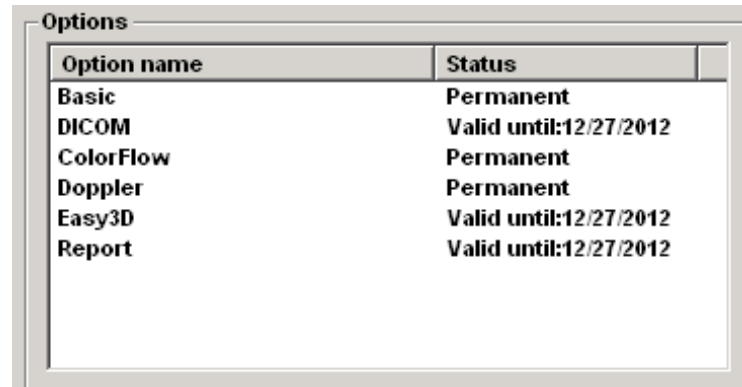

Figure 3-38 Valid new option

3-10-2 Option Key Update (cont'd)

The status of activated Options is described in two methods:

- **Valid until: (date)**. This status means the option is working only until the displayed date. After the date, the function of this option becomes disabled. If the options need to be activated again, the user need to apply for the option key and input it to activate the options.
- **Permanent**. This status means the option is working without a date limitation.



Option name	Status
Basic	Permanent
DICOM	Valid until:12/27/2012
ColorFlow	Permanent
Doppler	Permanent
Easy3D	Valid until:12/27/2012
Report	Valid until:12/27/2012

Figure 3-39 Valid option status

3-10-3 Probe Recognition

NOTE: After the system software loading completion, please check to ensure that the system can recognize the probes.

Plug in the probe. In scanning mode, the probe information is displayed on the **right top** location of the screen. For the probe specification for intended use on LOGIQ Book XP/XP PRO/XP Vet, please refer to [3-6-6 on page 3- 25](#).

Plug in at least one of each type of the probes and check if each of the probes is recognized and the probe information is displayed correctly.



Figure 3-40 Probe identification

3-10-4 All the Peripheral Devices Work Properly

Please check to ensure that all the peripheral devices work properly.

For the instruction of peripheral devices check, please refer to [Section 4-5 on page 3- 32](#).

3-10-5 Reinstall DICOM Devices

Reinstall any DICOM devices used by the customers and check to ensure these DICOM devices work properly.

The instruction about installing DICOM devices is not incorporated in this manual. To access the instruction about installing DICOM devices please refer to another manual **Basic User Manual**. Please use the latest revision of this document.

Section 3-11 Paperwork

NOTE: During and after installation, the documentation (i.e. User Manuals, Installation Manuals...) for the peripheral units must be kept as part of the original system documentation. This will ensure that all relevant safety and user information is available during the operation and service of the complete system.

3-11-1 Product Locator Installation

NOTE: The Product Locator Installation Card shown may not be same as the provided Product Locator card.

		GE Medical Systems Product Locator File P.O. Box 414 Milwaukee, WI 53201-0414		General Electric CGR Product Locator Adm. - DSE/SM 283 Route de la Miniere 78530 Buc, FRANCE		Yokogawa Medical Systems Ltd. GEMSA Service Administration 4-7-127 Asahigaoka Hino-shi Tokyo 191, JAPAN	
DESCRIPTION		FDA	MODEL		REV	SERIAL	
SYSTEM LTD.		OCP		BS	ORD	EMPLOYEE NO.	
		DISTRICT		ROOM		DATE (MO - DA - YR)	
INSTALLATION		CUSTOMER NO.					
		DESTINATION NAME AND ADDRESS					
46-303268 Rev 5		ZIP CODE					

Figure 3-41 Product Locator Installation Card

3-11-2 User Manual(s)

User Check that the correct User Manual(s) for the system and software revision, is included with the installation. Specific language versions of the User Manual may also be available. Check with your GE Sales Representative for availability.

Chapter 4

Functional Checks

Section 4-1 Overview

4-1-1 Purpose for Chapter 4

This chapter provides procedures for quickly checking major functions of the LOGIQ Book XP/XP PRO/XP Vet console, diagnostics by using the built-in service software, and power supply adjustments.

Table 4-27 Contents in chapter 4

Section	Description	Page Number
4-1	Overview	4-1
4-2	Required Equipment	4-1
4-3	General Procedure	4-2
4-4	Software Configuration Checks	4-32
4-5	Peripheral Checks	4-32

Section 4-2 Required Equipment

To perform these tests, you'll need any of the sector, linear, or convex transducers.
(normally you should check all the transducers used on the system)

Section 4-3 General Procedure

 **CAUTION SYSTEM REQUIRES ALL COVERS**
Operate this unit only when all board covers and frame panels are securely in place. The covers are required for safe operation, good system performance and cooling purposes.

 **NOTICE** Lockout/Tagout Requirements (For USA only)
Follow OSHA Lockout/Tagout requirements by ensuring you are in total control of the Power Cable on the system.



4-3-1 Power On/Boot Up

After AC/DC is connected correctly to the scanner, the power is applied to the scanner. When the Control panel **Power On/Off** key is pressed once, the System starts.

4-3-1-1 Scanner Power On

Lower the handle. Plug the AC adapter output connector into the system DC input port (located on the system's rear panel) with the arrow side upward. Plug the AC adapter power cord into a grounded, protective earth outlet.

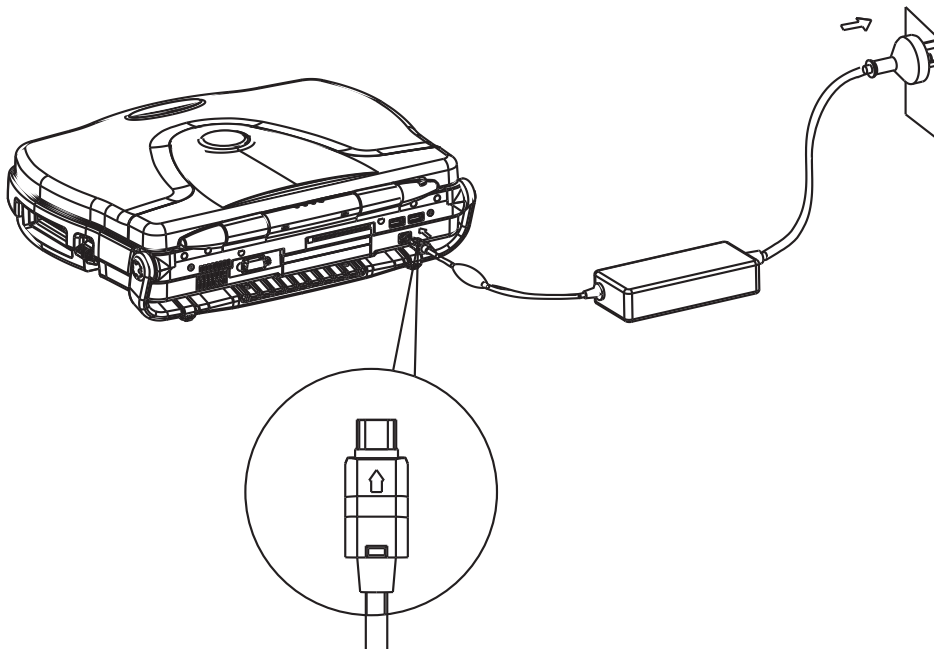

Figure 4-42 connect AC adapter

Scanner Power On (cont'd)

When power is applied to the scanner, power is distributed to the Cooling Unit, Control Panel, LCD, Peripherals and the Back-end Processor.

4-3-1-2 Turn on the system

Press the **Power On/Off** switch at the front of the system once.

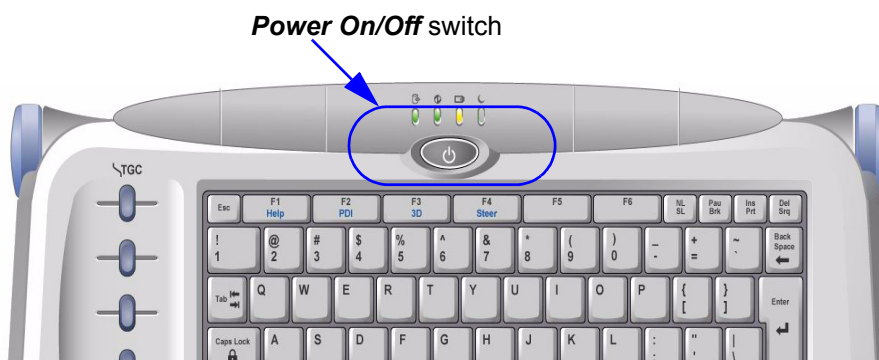

Figure 4-43 Power On/Off Switch

When the **Power On/Off** switch on the Control Panel is pressed once, the Back-end Processor starts and the software code is distributed to initiate the scanner.

No status messages are displayed during this process.

4-3-2 Power Off/ Shutdown

NOTE: After turning off a system, wait at least ten seconds before turning it on again. The system may not be able to boot if power is recycled too quickly.

4-3-2-1 Back-end Processor Power Down

To power down the system:

- 1.) Press the **Power On/Off** switch at the front of the system once.
- 2.) The System-Exit window is displayed.



Figure 4-44 System Exit Window

- 3.) Using the Trackball or Select key, select Shutdown.

Back-end Processor Power Down (cont'd)

- 4.) The shutdown process takes a few seconds and the power off sequence is complete when the power status LED is turned off.
- 5.) Disconnect the probes. Clean or disinfect all probes as necessary. Store them in their shipping cases to avoid damage.
- 6.) Close LCD cover.

4-3-2-2 Scanner Shutdown

Disconnect the Mains Power Cable is necessary. *For example:* Relocating the scanner.



CAUTION DO NOT unplug and/or transport the unit until after the power off sequence has been completed. Failure to do so may result in corrupted patient files.

4-3-3 Archiving and Loading Presets

NOTE: Always save presets before any software reload. This ensures the presets loaded after the software reload are as up-to-date as possible.

All user presets except changes to Summary, Anatomy, and Biometry pages, can be saved on an CD-R disk for reloading on the system.

 **NOTICE** Presets should NOT be saved on the same CD-R disk as images. The Archive Menu lists the images but does NOT list the presets stored on a CD-R disk.

4-3-3-1 Archiving Presets to an CD-R disk

- 1.) Insert an empty (blank) CD-R disk into the CD-RW.
- 2.) Access to the Utility Menu, and select Backup/Restore. The Backup sheet will be shown on the monitor.

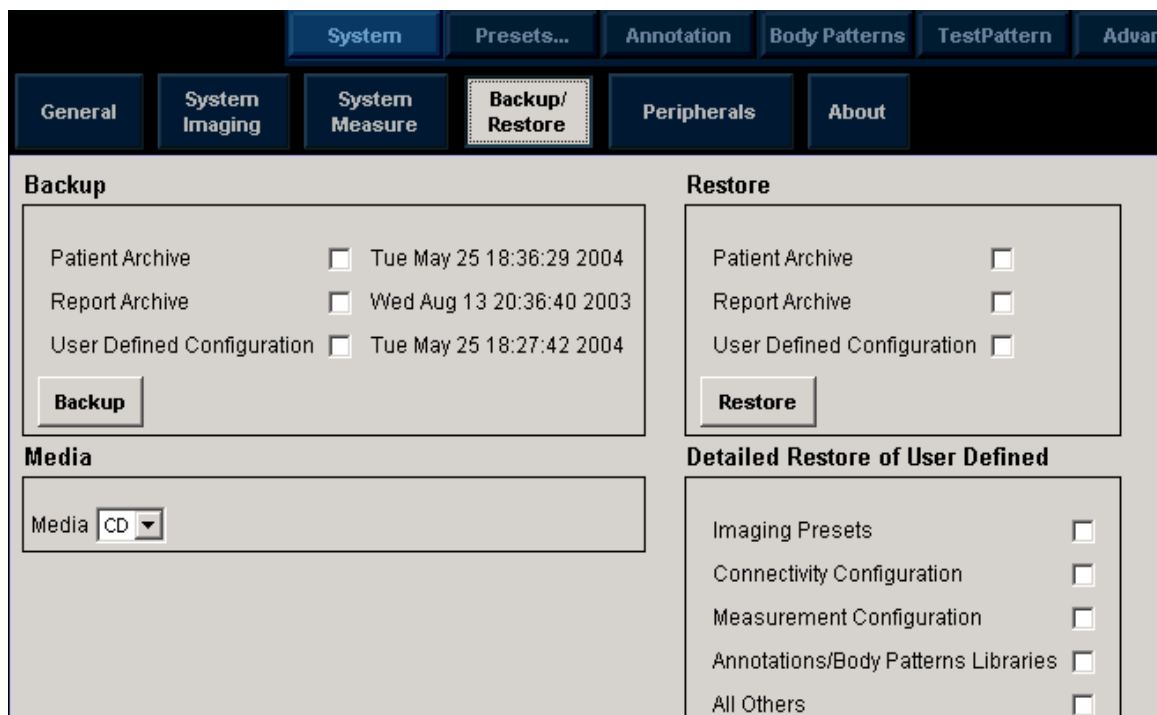

Figure 4-45 Backup Sheet

- 3.) Select the item to back up either from Resource Files.
- 4.) Enter backup destination or browse through the disk to locate the destination.
- 5.) Select Backup now. The backup status for each item is displayed on the Result column.

4-3-3-2 Loading Presets from an CD-R disk

- 1.) Insert the CD-R disk with the archived Presets into the CD-RW.
- 2.) Access to the Utility Menu, and select Backup/Restore. The Restore sheet will be shown on the LCD display. (see [Figure 4-45 on page 4-5](#))
- 3.) Select the item to restore either from Resource Files.
- 4.) Enter restore destination or browse through the disk to locate the destination.
- 5.) Select Restore. The restore status for each item is displayed on the Result column.

4-3-4 Adjusting the Display Monitor

4-3-4-1 Brightness

To adjust the brightness:

Adjust the Brightness Slide pots, located on the right of side of the LCD, see [Figure 4-46 on page 4-6](#) .



Figure 4-46 Brightness Slide pots

Record the final brightness setting and leave this information with the system.

4-3-5 Lockout/Tagout Requirements (For USA Only)

Follow OSHA Lockout/Tagout requirements (USA) or local Lockout/Tagout requirements by ensuring you are in total control of the AC power plug at all times during the service process.

To apply Lockout/Tagout:

- 1.) Plan and prepare for shutdown.
- 2.) Shutdown the equipment.
- 3.) Isolate the equipment.
- 4.) Apply Lockout/Tagout Devices.
- 5.) Remove battery.
- 6.) Control all stored and residual energy.
- 7.) Verify isolation.

All potentially hazardous stored or residual energy is relieved.

 **NOTICE** Energy Control and Power Lockout for LOGIQ Book XP/XP PRO/XP Vet

WHEN SERVICING PARTS OF THE SYSTEM WHERE THERE IS EXPOSURE TO VOLTAGE GREATER THAN 30 VOLTS:

1. TURN OFF THE SCANNER.
2. UNPLUG THE SYSTEM.
3. MAINTAIN CONTROL OF THE SYSTEM POWER PLUG.
4. WAIT FOR AT LEAST 20 SECONDS FOR CAPACITORS TO DISCHARGE AS THERE ARE NO TEST POINTS TO VERIFY ISOLATION. THE AMBER LIGHT ON THE OP PANEL ON/OFF BUTTON WILL TURN OFF.
5. REMOVE THE SYSTEM BATTERY.



4-3-6 System Features

4-3-6-1 Control Panel



Figure 4-47 Control Panel Tour

- 1.) TGC
- 2.) New Patient
- 3.) End Exam
- 4.) Mode/Gain/Auto Keys
- 5.) Preset Key
- 6.) Imaging/Measurement Keys
- 7.) Depth
- 8.) Reverse
- 9.) Image Keys
- 10.) Print Keys
- 11.) Freeze
- 12.) Keyboard

4-3-6-2 LOGIQ Book XP/XP PRO/XP Vet SoftMenu Key Tour

In general, there are three types of softMenu keys: Paddle Switch, Push Button and two-button key.



Figure 4-48 SoftMenu Key Tour

- 1.) The Paddle Switch is used to access the Sub SoftMenu.
- 2.) The Push Button Softkey is used to toggle between line one and line two.
- 3.) The up/down Two-button Softkeys are used to increase/decrease quantities.

4-3-6-3 Monitor Display

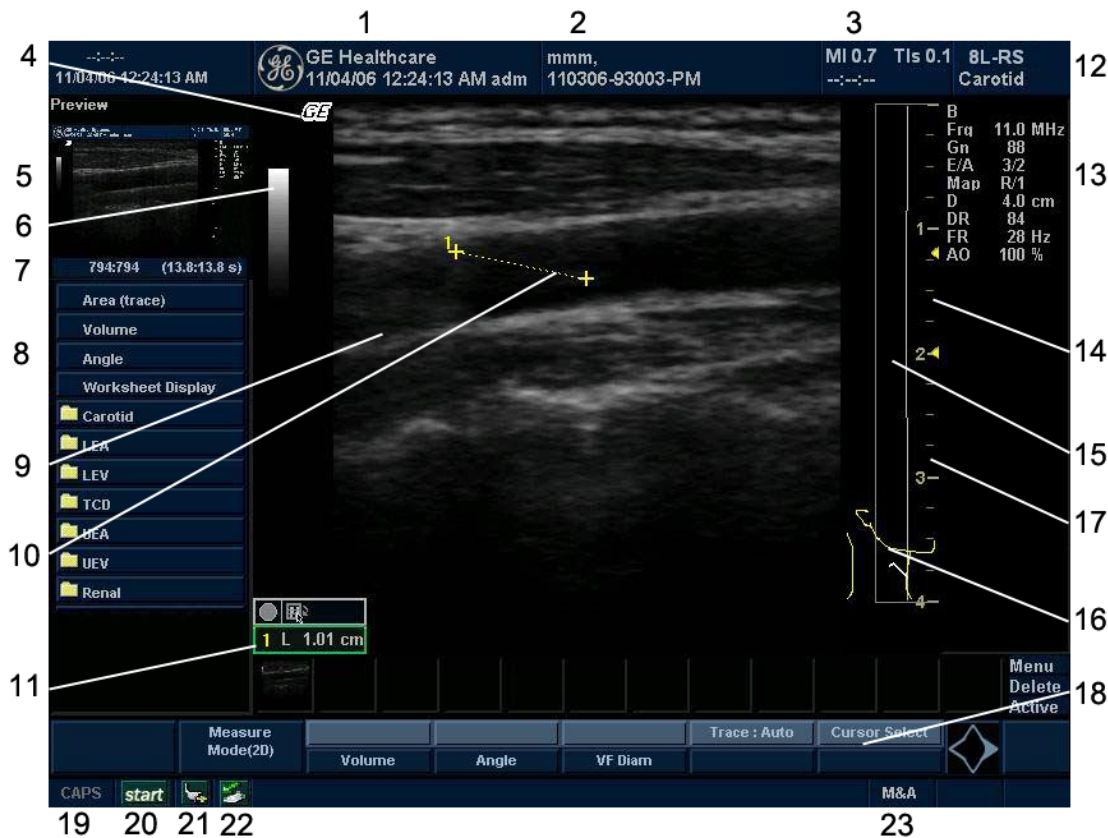

Figure 4-49 Monitor Display Tour

Table 4-28 Monitor Display Features

1. Institution/Hospital Name, Date, Time, Operator Identification, system status (real-time of frozen).	13. Imaging Parameters by Mode (current mode highlighted).
2. Patient Name, Patient Identification.	14. Focal Zone.
3. Acoustic Output Readout,	15. TGC (not shown on the image).
4. GE Symbol: Probe Orientation Marker. Coincides with a probe orientation marking on the probe.	16. Body Pattern.
5. Image Preview.	17. Depth Scale.
6. Gray/Color Bar.	18. SoftMenu
7. Cine Gauge.	19. Caps Lock: On/Off.
8. Measurement Summary Window.	20. Start Menu icon.
9. Image.	21. Battery icon.
10. Measurement.	22. Card icon.
11. Results Window.	23. Trackball Functionality Status: Scroll, M&A (Measurement and Analysis), Position, Size, Scan Area Width and Tilt.
12. Probe Identifier. Exam Study.	

4-3-7 B Mode Checks

4-3-7-1 Preparations

- 1.) Connect one of the probes listed in 3-6-6 "Available Probes" on page 3-25, in Chapter 3 Installation to the System probe connector.
- 2.) Turn ON the scanner (if it isn't turned on already)

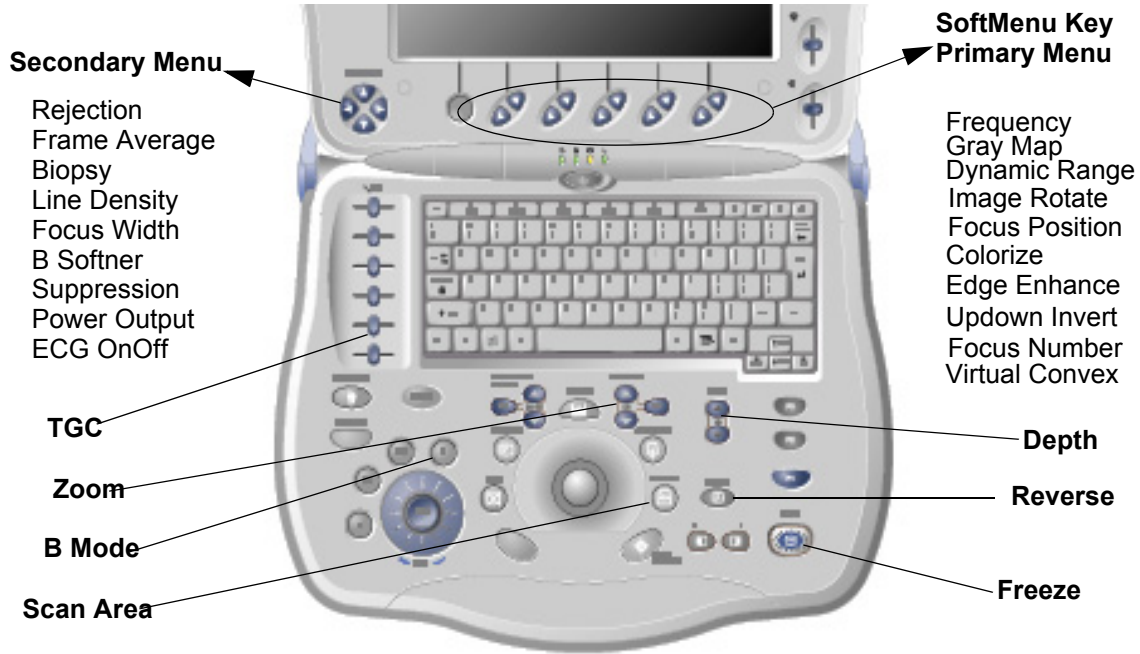

Figure 4-50 Controls available in B Mode

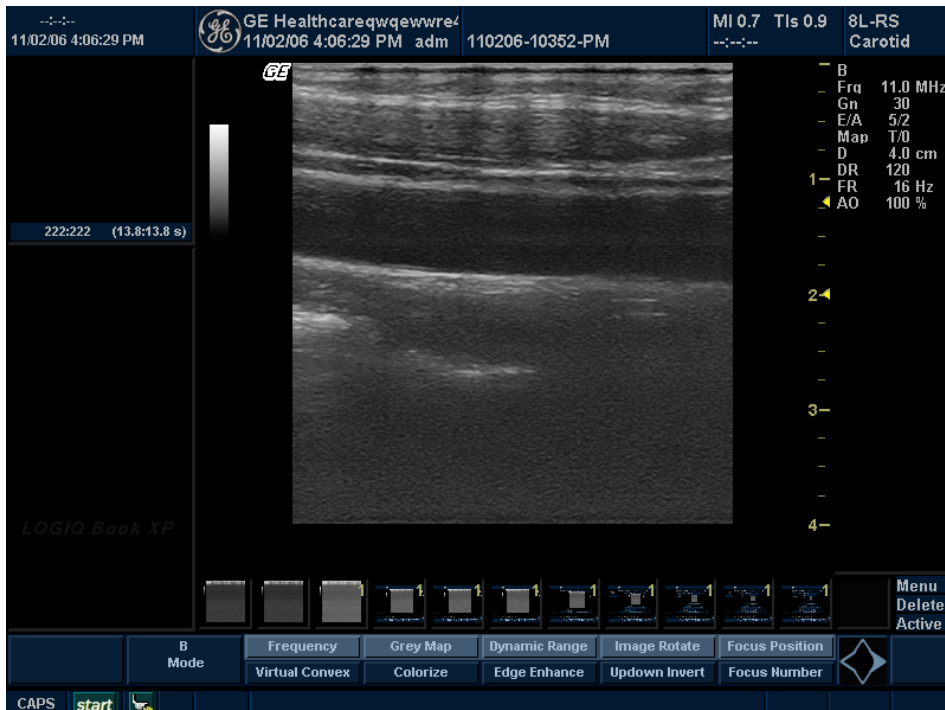

Figure 4-51 B Mode Screen Picture Example

4-3-7-2 B Mode OP Panel Controls

Table 4-29 B Mode Control Panel Controls

Step	Task	Expected Result(s)
1	Press B Mode key	B Mode Starts
2	Adjust Depth	Adjust the field of view. Increasing the depth may view larger/deeper structures rates, and decreasing the depth may view near the skin line. Press Up/Down Button to increase/decrease. Depth displays on the monitor in cm.
3	Adjust Gain	Controls the amount of echo information displayed in an image. Turn B Mode dial to the left/right to increase/decrease Gain. Gain displays on the monitor in G (dB).
4	Adjust Focus	Increases the number of focal zones or moves the focal zone(s) to tighten up the beam for specific area. Press the control to toggle between Focus Position and Focus Number. Press Up/Down Button to move or adjust the focal numbers.
5	Activate Auto Optimize	Optimize the image based upon a specified region of interest or anatomy. Press the Center Button in the Gain Dial to toggle the ATO/ACE On and Off.
7	Adjust Time Gain Compensation (TGC)	Amplifies the returning signals to correct for the attenuation caused by tissues at increasing depth. TGC slide pots spaced proportional to the depth. Move the slide pots to the left/right to decrease/increase TGC. A TGC curve appears on the display.
8	Adjust Scan Area	Widen or narrow the size of the sector angle to maximize the image's region of interest (ROI). Press Scan Area and move the Trackball to narrow/widen the angle.
9	Adjust Zoom	Changes the location of the focal point(s). A triangular focus marker indicates the depth of the focal point.
10	Zoom Clear	Clear Zoom to normal condition.
11	Reverse	Toggles the left/right orientation of the scan image.

4-3-7-3 B Mode Softmenu Key

Table 4-30 B Mode Softmenu Key

Step	Task	Expected Result(s)
1	Adjust Rejection	Selects a level below which echoes will not be amplified (an echo must have a certain minimum amplitude before it will be processed).
2	Activate Colorize	Enables gray scale image colorization. To deactivate, reselect a Gray Map.
3	Adjust Edge Enhance	Edge Enhance brings out subtle tissue differences and boundaries by enhancing the gray scale differences corresponding to the edges of structures. Adjustments to M Mode's edge enhancement affects the M Mode only.
4	Activate Gray Map	Determines how the echo intensity levels received are presented as shades of gray.
5	Adjust Frequency	Multi Frequency mode lets you downshift to the probe's next lower frequency or shift up to a higher frequency.
6	Adjust Frame Average	Temporal filter that averages frames together. This has the effect of presenting a smoother, softer image.
7	Adjust Rotation	Rotates the image by selecting the value from the pop-up menu.
9	Adjust Line Density	Optimizes B Mode frame rate or spatial resolution for the best possible image.
10	Power output	Optimizes image quality and allows user to reduce beam intensity. 10% increments between 0-100%. Values greater than 0.1 are displayed.
11	Dynamic Range	Dynamic Range controls how echo intensities are converted to shades of gray, thereby increasing the adjustable range of contrast.
12	Focus Number and Position	Increases the number of transmit focal zones or moves the focal zone(s) so that you can tighten up the beam for a specific area. A graphic caret corresponding to the focal zone position(s) appears on the right edge of the image.
13	ECG OnOff	On/Off ECG function

4-3-8 M Mode Controls

4-3-8-1 Preparations

- 1.) Connect one of the probes listed in 3-6-6 "Available Probes" on page 3-25, in Chapter 3 Installation to the System probe connector.
- 2.) Turn ON the scanner (if it isn't turned on already).



Figure 4-52 Controls available in M Mode



Figure 4-53 M Mode Screen Picture Example

4-3-8-2 M Mode OP Panel Controls**Table 4-31 M Mode OP Panel Controls**

Step	Task	Expected Result(s)
1	Press M Mode key	M Mode Starts
2	Adjust Gain	Controls the amount of echo information displayed in an image. Turn B Mode dial to the left/right to increase/decrease Gain. Gain displays on the monitor in G (dB).
3	Display M-Mode Cursor	Displays the M-Mode cursor on the B-Mode image. Press Cursor and Trackball to position M-Mode Cursor.

4-3-8-3 M Mode Softmenu Key

Table 4-32 M Mode Softmenu Key

Step	Task	Expected Result(s)
1	Adjust Rejection	Selects a level below which echoes will not be amplified (an echo must have a certain minimum amplitude before it will be processed).
2	Adjust Sweep Speed	Changes the speed at which the time line is swept. The following speed values are available, 1, 2, 3, 4, 6, 8, 12, 16.
3	Adjust Edge Enhance	Edge Enhance brings out subtle tissue differences and boundaries by enhancing the gray scale differences corresponding to the edges of structures. Adjustments to M Mode's edge enhancement affects the M Mode only.
4	Activate Gray Map	Determines how the echo intensity levels received are presented as shades of gray.
6	Activate Colorize	Enables gray scale image colorization. To deactivate, reselect a Gray Map.
7	Activate Full Timeline	Displays only timeline screen. Press the Full Timescreen to activate.
8	Select Display Format	Select the format to display B image and M image on the LCD. Press Display Format, and select from the pop up menu.
9	Adjust Dynamic Range	Dynamic Range controls how echo intensities are converted to shades of gray, thereby increasing the adjustable range of contrast.
10	Power output	Optimizes image quality and allows user to reduce beam intensity. 10% increments between 0-100%. Values greater than 0.1 are displayed.

4-3-9 Color Flow Mode Checks*

 **NOTICE** * This function is option on Vet and Pro American Version.

4-3-9-1 Preparations

- 1.) Connect one of the probes listed in [3-6-6 "Available Probes" on page 3-25](#), in Chapter 3 Installation to the System probe connector.
- 2.) Turn ON the scanner (if it isn't turned on already).



Figure 4-54 Controls available in Color Flow Mode

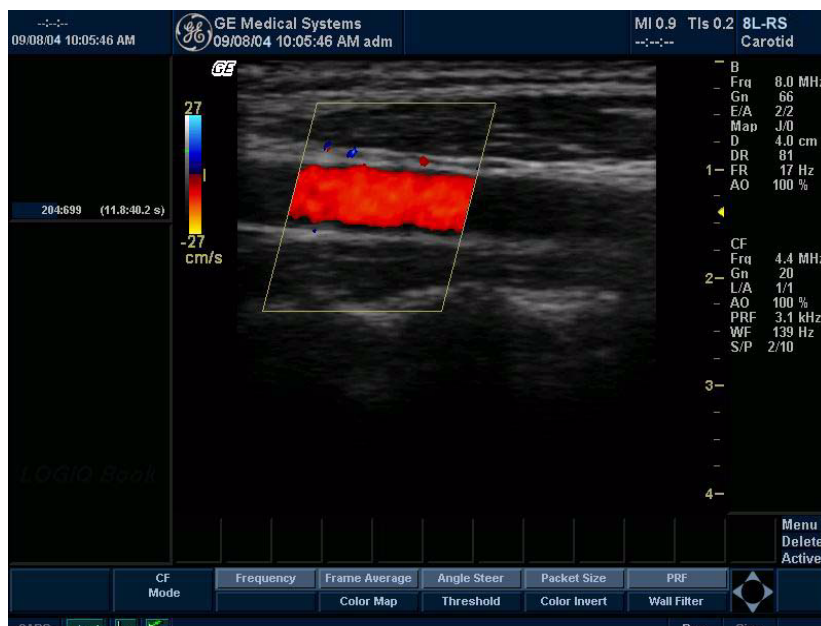

Figure 4-55 CFM Mode Screen Picture Example

4-3-9-2 Color Flow Mode OP Panel Controls

Table 4-33 Color Flow Mode OP Panel Controls

Step	Task	Expected Result(s)
1	Press CFM-Mode key	CFM Mode Starts
2	Adjust Gain	Amplifies the overall strength of the echoes processed in the Color Flow window. Turn the Gain dial (CFM Mode key) to the left/right to increase/decrease Gain.

4-3-9-3 Color Flow Mode Softmenu Key

Table 4-34 Color Flow Mode Softmenu Key

Step	Task	Expected Result(s)
1	Threshold	Threshold assigns the gray scale level at which color information stops.
2	Packet Size	Controls the number of samples gathered for a single color flow vector.
3	Select Color maps	Allows a specific color map to be selected. After a selection has been made, the color bar displays the resultant map.
4	Adjust Frequency	Enables the adjustment of the probe's operating frequency. Press Frequency and select desired value. The selected frequency is displayed in the status window.
5	Set Frame Average	Averages color frames. Press Frame Average up/down to smooth temporal averaging.
6	Color Invert	Views blood flow from a different perspective. Press Invert to reverse the color map.
7	Adjust Line Density	Trades frame rate for sensitivity and spatial resolution. If the frame rate is too slow, reduce the size of the region of interest, select a different line density setting, or reduce the packet size.
8	Activate Spatial Filter	
9	Activate ACE	Eliminates the motion artifacts. Press Ace to activate.
10	Adjust Quick angle	Slants the Color Flow region of interest or the Doppler line to obtain a better Doppler angle.
11	Move Baseline	Adjusts the baseline to accommodate faster or slower blood flows to eliminate aliasing.
12	Change PRF (Pulse Repetition Frequency)	Velocity scale determines pulse repetition frequency. If the sample volume gate range exceeds single gate PRF capability, the system automatically switches to high PRF mode. Multiple gates appear, and HPRF is indicated on the display.
13	Focus Position	Increases the number of transmit focal zones or moves the focal zone(s) so that you can tighten up the beam for a specific area. A graphic caret corresponding to the focal zone position(s) appears on the right edge of the image.
14	Capture	
15	Power output	Optimizes image quality and allows user to reduce beam intensity. 10% increments between 0-100%. Values greater than 0.1 are displayed.

Table 4-34 Color Flow Mode Softmenu Key

Step	Task	Expected Result(s)
16	Wall Filter	Wall Filter insulates the Doppler signal from excessive noise caused from vessel movement.

4-3-10 Doppler Mode Checks*

 **NOTICE** *This function is option on Vet and Pro American Version.

4-3-10-1 Preparations

- 1.) Connect one of the probes listed in [3-6-6 "Available Probes" on page 3-25](#), in Chapter 3 Installation to the System probe connector.
- 2.) Turn ON the scanner (if isn't turned on already).



Figure 4-56 Controls available in Doppler Mode



Figure 4-57 Doppler Mode Screen Picture Example

4-3-10-2 Doppler Mode OP Panel Controls

Table 4-35 Doppler Mode OP Panel Controls

Step	Task	Expected Result(s)
1	Press PW Mode key	PW Mode Starts
2	Adjust Gain	Amplifies the overall strength of the echoes processed in the Color Flow window. Turn the Gain dial (PW Mode key) to the left/right to increase/decrease Gain.
3	Display M/D-Mode Cursor	Displays the M/D-Mode cursor on the B-Mode image. Press Cursor and Trackball to position sample volume graphic. Click SV gate to adjust sample volume gate size.
4	B Pause	Toggle between simultaneous and update presentation while viewing Spectral Doppler. Press B Pause to toggle between simultaneous and update.

4-3-10-3 Doppler Mode OP Panel Controls

Table 4-36 Doppler Mode Softmenu Key

Step	Task	Expected Result(s)
1	Adjust Rejection	Selects a level below which echoes will not be amplified (an echo must have a certain minimum amplitude before it will be processed).
2	Adjust Sweep Speed	Changes the speed at which timeline is swept. Press Sweep Speed up/down to increase/decrease the value.
3	Activate Full Timeline	Displays only timeline screen. Press the Full Timescreen to activate.
4	Select Display Format	Display layout can be preset to have B-Mode and Time-motion side-by-side or over-under.
5	Adjust Frequency	Enables the adjustment of the probe's operating frequency. Press Frequency and select desired value. The selected frequency is displayed in the status window.
6	Trace Direction	
7	Invert	Vertically inverts the spectral trace without affecting the baseline position. Press invert to invert the spectral trace. The Plus and Minus signs on the velocity scale reverse when the spectrum is inverted.
8	Auto Calculation	
9	Modify Calcs	
10	Trace Method	
11	Activate Colorize	Colorize the gray scale image to enhance the eyes' discrimination capability. Press the Colorize, Trackball to cycle through available maps and press Set to select.
12	Activate Gray Map	Displays a map window adjacent to the image. Move the trackball to select the map. The image reflects the map as scrolled through the selections. Press Set to select.
13	Dynamic Range	Controls how echo intensities are converted to shades of gray. Click Dynamic Range to increase/decrease the value.
14	Adjust Angle Correct	Estimates the flow velocity in a direction at an angle to the Doppler vector by computing the angle between the Doppler vector and the flow to be measured.
15	Adjust Quick Angle	Estimates the flow velocity in a direction at an angle to the Doppler vector by computing the angle between the Doppler vector and the flow to be measured. Currently only support +/- 30, +/- 60 degree.
16	Move Baseline	Adjusts the baseline to accommodate faster or slower blood flows to eliminate aliasing.

Table 4-36 Doppler Mode Softmenu Key

Step	Task	Expected Result(s)
17	Change PRF (Pulse Repetition Frequencies) - (Wall Filter)	Velocity scale determines pulse repetition frequency. If the sample volume gate range exceeds single gate PRF capability, the system automatically switches to high PRF mode. Multiple gates appear, and HPRF is indicated on the display.
18	Trace Sensitivity	
19	Time Resolution	
20	Spectral Average	
21	Power output	Optimizes image quality and allows user to reduce beam intensity. 10% increments between 0-100%. Values greater than 0.1 are displayed.
22	SV Length	Sizes the sample volume gate.
23	Wall Filter	Wall Filter insulates the Doppler signal from excessive noise caused from vessel movement.

4-3-11 Basic Measurements

NOTE: The following instructions assume that you first scan the patient and then press **Freeze**.

4-3-11-1 Distance and Tissue Depth Measurements

- 1.) Press **MEASURE** once; an active caliper displays.
- 2.) To position the active caliper at the start point (distance) or the most anterior point (tissue depth), move the **TRACKBALL**.
- 3.) To fix the start point, press **Set**. The system fixes the first caliper and displays a second active caliper.
- 4.) To position the second active caliper at the end point (distance) or the most posterior point (tissue depth), move the **TRACKBALL**.
- 5.) To complete the measurement, press **SET**. The system displays the distance or tissue depth value in the measurement results window.

Before you complete a measurement:

To toggle between active calipers, press **MEASURE**.

To erase the second caliper and the current data measured and start the measurement again, press **CLEAR** once.

NOTE: To rotate through and activate previously fixed calipers, adjust **CURSOR SELECT**.

NOTE: After you complete the measurement, to erase all data that has been measured to this point, but not data entered onto worksheets, press **CLEAR**.

4-3-11-2 Circumference/Area (Ellipse) Measurement

- 1.) Press **MEASURE** once; an active caliper displays.
- 2.) To position the active caliper, move the **TRACKBALL**.
- 3.) To fix the start point, press **SET**. The system fixes the first caliper and displays a second active caliper.
- 4.) To position the second caliper, move the **TRACKBALL**.
- 5.) Adjust the **ELLIPSE**; an ellipse with an initial circle shape appears.

NOTE: Be careful not to press the Ellipse control as this activates the Body Pattern.

- 6.) To position the ellipse and to size the measured axes (move the calipers), move the **TRACKBALL**.
- 7.) To increase the size, adjust the **ELLIPSE** upward button. To decrease the size, adjust the **ELLIPSE** downward button.
- 8.) To toggle between active calipers, press **MEASURE**.
- 9.) To complete the measurement, press **SET**. The system displays the circumference and area in the measurement results window.

Before you complete a measurement:

- To erase the ellipse and the current data measured, press **CLEAR** once. The original caliper is displayed to restart the measurement.
- To exit the measurement function without completing the measurement, press **CLEAR** a second time.

4-3-11-3 Worksheets

Measurement/Calculation worksheets are available to display and edit measurements and calculations. There are generic worksheets as well as Application specific worksheets. The worksheets are selected from the Measurement Touch Panel.

4-3-11-4 Report* Pages

Measurements/Calculations that are included on the worksheet can also be displayed on Report Pages. Report Pages can be customized to meet the appropriate needs of the user.



NOTICE * This function is not available on Pro American Version.

4-3-12 Probe/Connectors Usage

4-3-12-1 Connecting a probe

- 1.) Place the probe's carrying case on a stable surface and open the case.
- 2.) Carefully remove the probe and unwrap the probe cable.
- 3.) **DO NOT** allow the probe head to hang free. Impact to the probe head could result in irreparable damage.
- 4.) Align the connector with the probe port and carefully push into place.
- 5.) Lock the probe latch upward.
- 6.) Carefully position the probe cord so it is free to move and is not resting on the floor.

4-3-12-2 Activating the probe

The probe activates in the currently-selected operating mode. The probe's default settings for the mode and selected exam are used automatically.

4-3-12-3 Deactivating the probe

When deactivating the probe, the probe is automatically placed in standby mode.

- 1.) Press the **Freeze** key.
- 2.) Gently wipe the excess gel from the face of the probe. (Refer to the Basic User Manual for complete probe cleaning instructions.)
- 3.) Carefully slide the probe around the right side of the keyboard, toward the probe holder. Ensure that the probe is placed gently in the probe holder.

4-3-12-4 Disconnecting the probe

Probes can be disconnected at any time. However, the probe should not be selected as the active probe.

- 1.) Unlock the probe latch downward.
- 2.) Pull the probe and connector straight out of the probe port.
- 3.) Carefully slide the probe and connector away from the probe port and around the right side of the keyboard.
- 4.) Ensure the cable is free.
- 5.) Be sure that the probe head is clean before placing the probe in its storage box.



WARNING *Take the following precautions with the probe cables: Do not bend. If you have purchased the cart option, be sure to keep probe cables free from the wheels.*



WARNING *Be careful not to trip on the probe cables if using the device without the optional cart.*

4-3-13 Using Cine

4-3-13-1 Activating CINE

Press **Freeze**, then roll the **Trackball** to activate CINE. To start CINE Loop playback, press Run/Stop. To stop CINE Loop playback, press Run/Stop.

4-3-13-2 Quickly Move to Start/End Frame

Press **First** to move to the first CINE frame; press **Last** to move to the last CINE frame.

4-3-13-3 Start Frame/End Frame

Press the **Start Frame** Two-Button Softkey to move to the beginning of the CINE Loop. Adjust the **Start Frame** up/down Two-Button Softkey upward to move forward through the CINE Loop. Adjust the Softkey downward to move backward through the CINE Loop.

Press the **End Frame** Two-Button Softkey to move to the end of the CINE Loop. Adjust the **End Frame** up/down Two-Button Softkey upward to move forward through the CINE Loop. Adjust the Softkey downward to move backward through the CINE Loop.

4-3-13-4 Adjusting the CINE Loop Playback Speed

Adjust the **Loop Speed** up/down Two-Button Softkey to increase/decrease the CINE Loop playback speed.

4-3-13-5 Moving through a CINE Loop Frame By Frame

Adjust the **Frame by Frame** up/down Two-Button Softkey to move through CINE memory one frame at a time.

4-3-14 Image Management (QG)

For Image Management functionality refer to the LOGIQ Book XP/XP PRO/XP Vet Quick Guide. It talks about several topics:

- Clipboard
- Printing Images
- Browsing and Managing an Exam's Stored Image
- Connectivity, and Dataflow Concept and Creation
- Starting an Exam
- Configuring Connectivity
- TCP/IP
- Services (Destinations)
- Buttons
- Views
- Verifying and Pinging a Device

4-3-15 Backup and Restore Database, Preset Configurations and Images

4-3-15-1 Formatting Media

- 1.) To format the backup media, CD-RW, select the UTILITY button on the Keyboard.
- 2.) Select CONNECTIVITY, then TOOLS. Properly label and Insert the backup media.
- 3.) Select the media type from the drop down menu.
- 4.) Enter the label for the media as shown in [Figure 4-58 on page 4-27](#) . It is best to use all capital letters with no spaces or punctuation marks. Press Format.

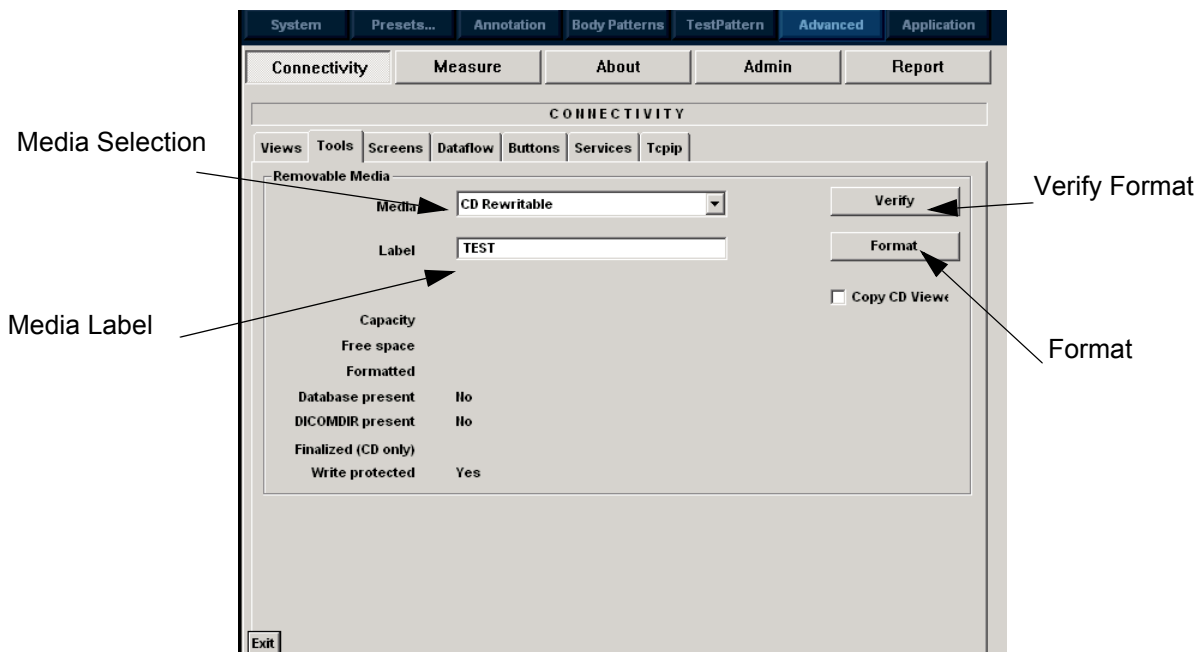

Figure 4-58 Format and Verify Media

- 5.) The Ultrasound system displays a pop-up menu, as shown in [Figure 4-59 on page 4-27](#) . When the formatting has been completed, press OK to continue.
- 6.) If desired, verify that the format was successful by returning to *Utility>Advanced>Connectivity>Tools* and selecting VERIFY as shown in [Figure 4-58 on page 4-27](#) .

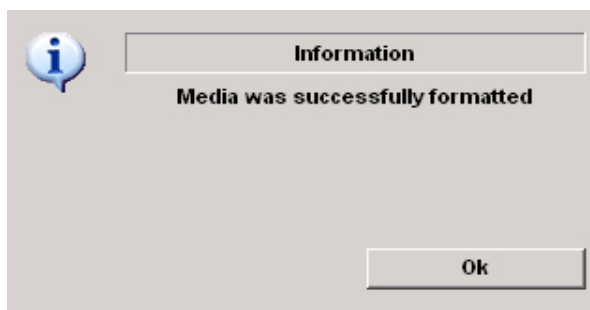

Figure 4-59 Format Successful Pop-up Menu

4-3-15-2 Backup System Presets and Configurations

NOTE: Always backup any preset configurations before a software reload. This ensures that if the presets need to be reloaded, after the software update, they will be the same ones the customer was using prior to service.

- 1.) Insert a formatted CD-R into the drive.
- 2.) On the Keyboard, press UTILITY.
- 3.) On the LCD display, press SYSTEM.
- 4.) On the LCD display, select BACKUP/RESTORE.

NOTE: If you are not logged in as GE Service or with administrator privileges, the Operator Login window is displayed. Log on with administrator privileges.

- 5.) In the Backup list, select Patient Archive, Report* Archive and User Defined Configuration.
- 6.) In the Media field, select CD-RW.
- 7.) Select BACKUP.

The system performs the backup. As it proceeds, status information is displayed on the Backup/Restore screen.



NOTICE * This function is not available on Pro American Version.

Check here to backup presets and configurations

Figure 4-60 Backup/Restore Menu

4-3-15-3 Restore System Presets and Configurations

CAUTION The restore procedure **overwrites** the existing database on the local hard drive. Make sure to insert the correct CD.

- 1.) Insert the Backup/Restore CD-R into the drive.
- 2.) On the Keyboard, press UTILITY.
- 3.) On the LCD display, press SYSTEM.
- 4.) On the LCD display, select BACKUP/RESTORE.

NOTE: *If you are not logged in with administrator privileges, the Operator Login window is displayed. Log on with administrator privileges.*

- 5.) In the Restore list, select Patient Archive, Report* Archive and User Defined Configuration.
- 6.) In the Media field, select the Backup/Restore CD-RW.
- 7.) Select RESTORE.

The system performs the restore. As it proceeds, status information is displayed on the Backup/Restore screen.

NOTICE * This function is not available on Pro American Version.

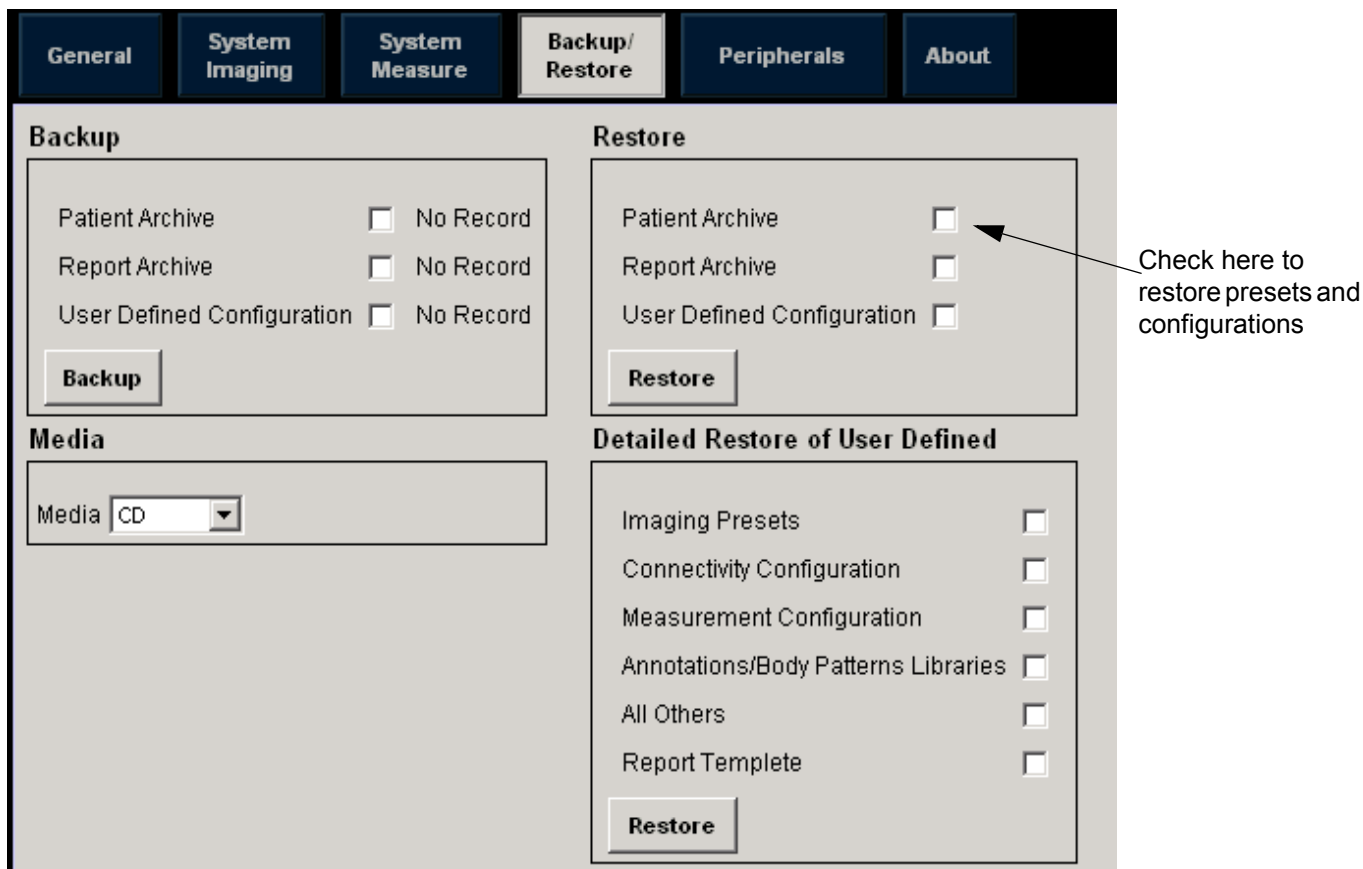

Figure 4-61 Backup/Restore Menu

4-3-15-4 Archiving Images

- 1.) Insert the archive media. To format the archive media, CD-RW, select the Utility button on the Keyboard.
- 2.) Select Connectivity, then Tools.
- 3.) Format the CD-RW. Verify the format if desired.
- 4.) Images will be moved from the hard drive by date. Therefore, the best way is to label media by date.

NOTE: *Images will be moved from the hard drive by date. Therefore, the best way to label media is by date. When images are moved to the archive media, they will be deleted from the system hard drive. However, the patient database (backed up earlier) maintains pointers to the location of the images on the archive media.*

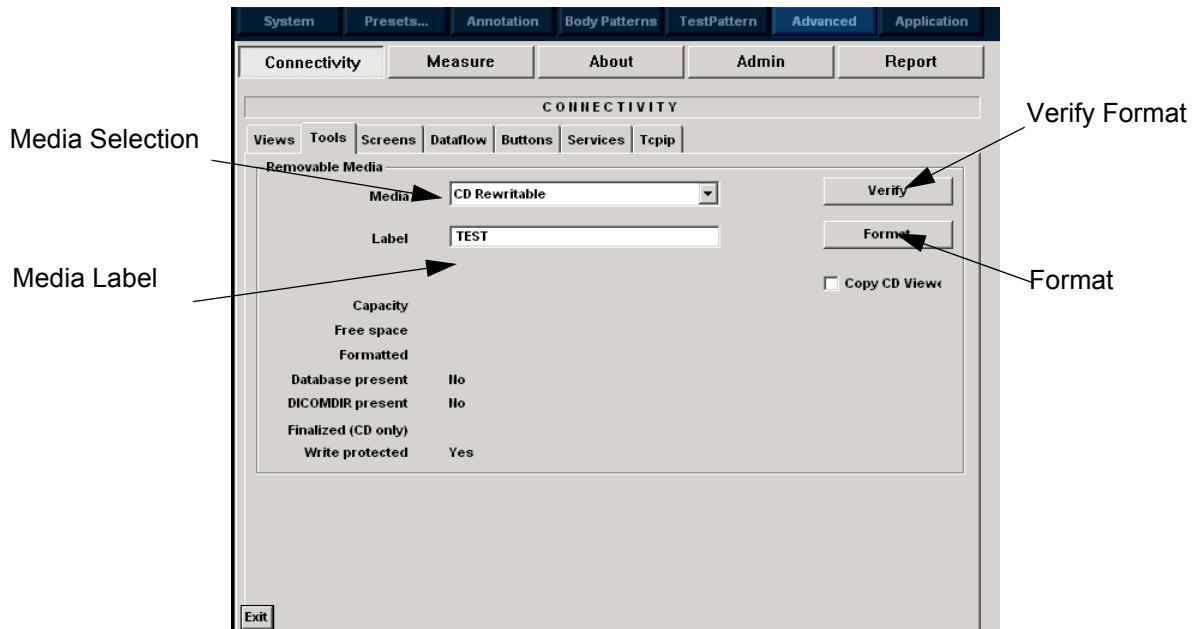

Figure 4-62 Format CD-ROM Screen

- 5.) Press PA TIENT and set the Dataflow to store images directly to CD-RW.
- 6.) From the patient screen, press MO R E, then select Move Images. The Move Images pop-up appears.

4-3-15-4 Archiving Images (cont'd)

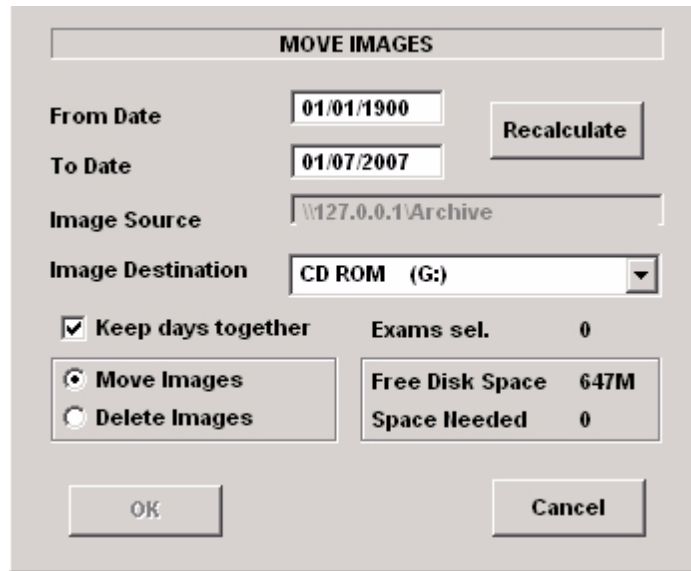

Figure 4-63 Image Archive Move Pop-up Menu

- 7.) Fill in the *From Date* and *To Date*. Specify to *Keep days together*.
- 8.) Press RECALCULATE.
- 9.) Press OK. An in-progress message appears. The archive operation is complete when you receive the message shown in [Figure 4-64 on page 4-31](#) .

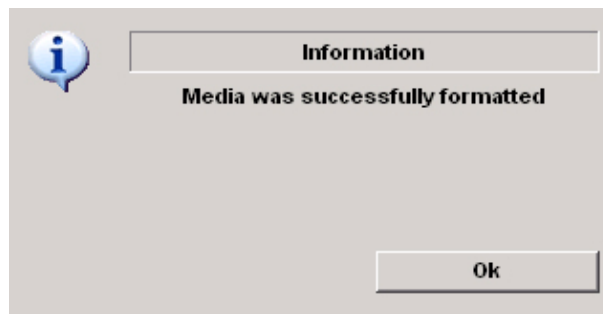

Figure 4-64 Archive Operation Complete Message

- 10.) Repeat the image move steps until all images have been archived. All databases, presets and images should now be saved to removable media.

Section 4-4 Software Configuration Checks

Table 4-37 Software Configuration Checks

Step	Task to do	Expected Result(s)
1.	Check Date and Time setting	Date and Time are correct
2.	Check that Location (Hospital Name) is correct	Location Name is correct
3.	Check Language settings	Desired Language is displayed
4.	Check assignment of Printer Keys	The default function for Print1-3 Key is P1 (store image); P2 (print); P3 (capture screen). Print1-3 Key can also be assigned as desired by the customer
5.	Check that all of the customer's options are set up correct	All authorized functions are enabled

Section 4-5 Peripheral Checks

Check that peripherals work as described below:

Table 4-38 Peripheral Checks

Step	Task to do	Expected Result(s)
1.	Press (FREEZE)	Stop image acquisition.
2.	Press (PRINT 2) on the Control Panel	The image displayed on the screen is printed on B&W printer.
3.	Connect with Footswitch on USB port and press once.	To start image acquisition (the same function as (FREEZE) key).

Chapter 5

Components and Functions (Theory)

Section 5-1 Overview

This chapter explains LOGIQ Book XP/XP PRO/XP Vet's system concepts, component arrangement, and subsystem function. It also describes the Power Distribution System (PDS) and probes.

Table 5-39 Contents in Chapter 5

Section	Description	Page Number
5-1	Overview	5-1
5-2	Block Diagrams and Theory	5-2
5-3	PWA (Printed Wire Assembly) Assy Diagrams	5-10
5-4	Power Diagrams	5-18
5-5	Common Service Platform	5-23

Section 5-2 Block Diagrams and Theory

5-2-1 Block Diagram

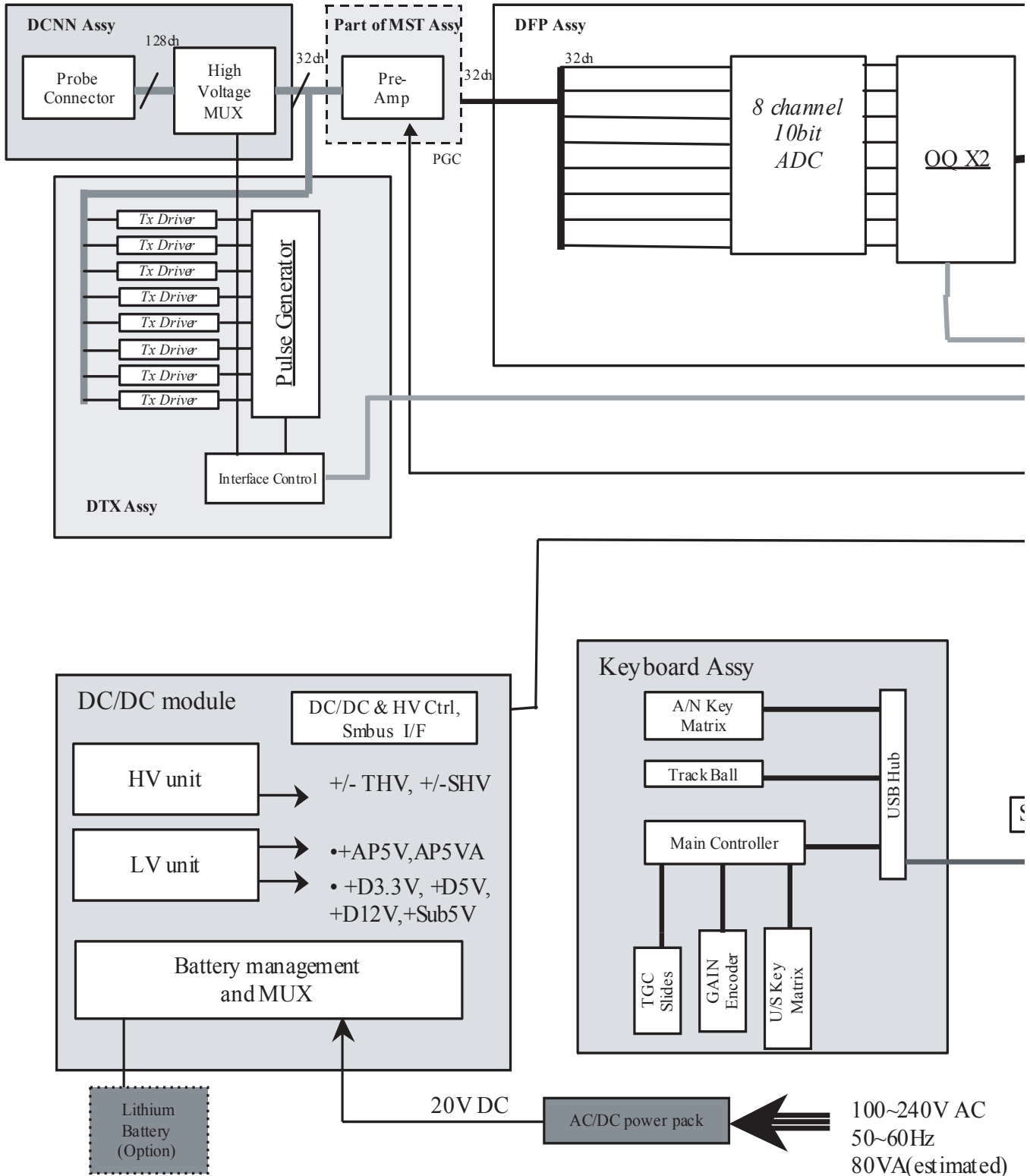

Figure 5-65 LOGIQ Book XP/XP PRO/XP Vet System Block Diagram

Block Diagram (cont'd)

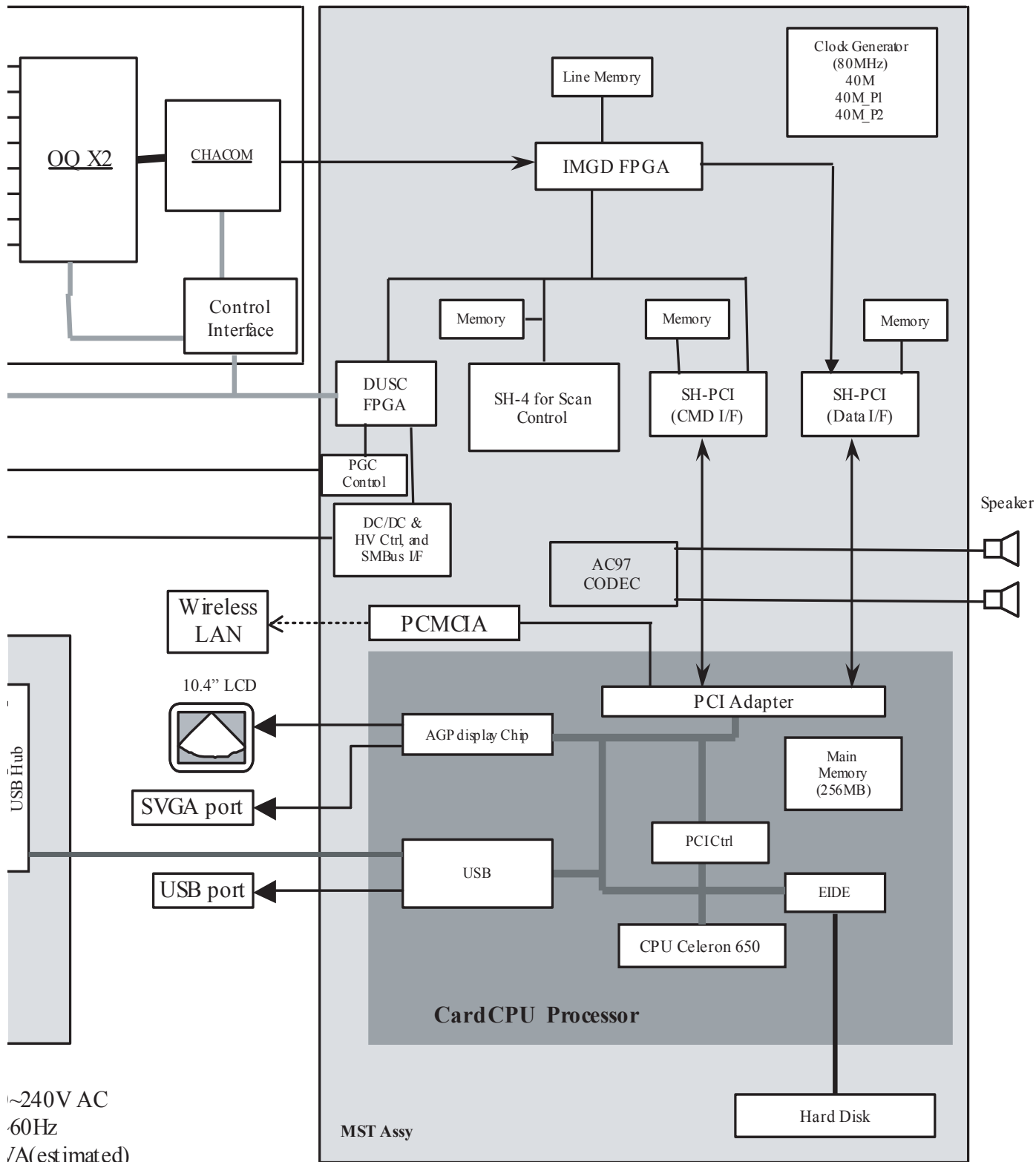

Figure 5-66 LOGIQ Book XP/XP PRO/XP Vet System Block Diagram (cont'd)

Block Diagram (cont'd)

- Pre Amp: Preamplifier
- OQX2: Beamforming ASIC
- CHACOM: B/M/CFM*/DOP* mode signal processor ASIC
- SH-PCI: PCI bridge located between SH4 and PCI bus
- HV unit: High voltage unit
- LV unit: Low voltage unit
- DC/DC & HV Ctrl, SMBUS I/F: DC/DC high voltage control smart bus interface
- IMGD FPGA: Image data processing FPGA
- DUSC FPGA: LOGIQ Book XP/XP PRO/XP Vet Ultrasound controlling FPGA

5-2-2 General Information

- LOGIQ Book XP/XP PRO/XP Vet is a linear array ultrasound imaging scanner.
- The system can be used for:
 - 2D Black and White imaging
 - 2D Color Flow*
 - M-Mode Black and White imaging
 - Color M-Mode
 - Doppler*
 - A number of combinations of the above
- LOGIQ Book XP/XP PRO/XP Vet is a digital beam forming system that can handle up to 128 element linear probes.
- Signal flow from the Probe Connector Panel to the Front End, to the Mid Processors and Back End Processor and finally to the LCD and peripherals.
- System configuration is stored on a hard disk and all necessary software is loaded from the hard disk on power up.



NOTICE * Color Flow and Doppler mode are options on Vet and Pro American Version.

5-2-3 Front End

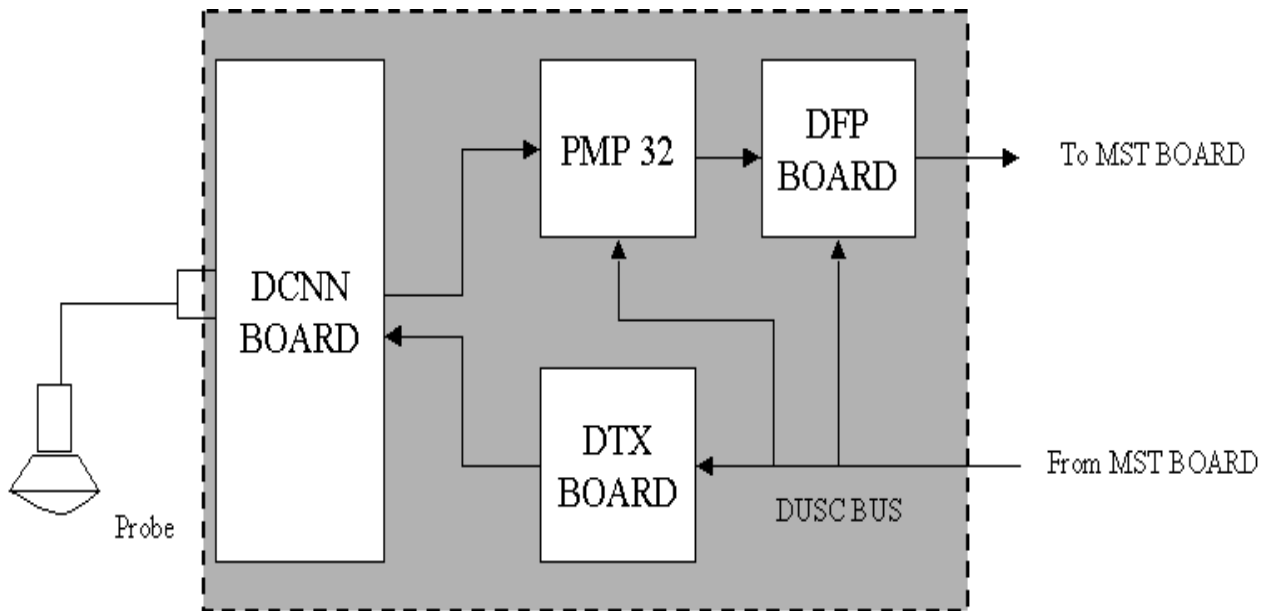

Figure 5-67 The Front End

The front end generates the strong transmit bursts, transmitted by the probes as ultrasound into the body. It also receives weak ultrasound echoes from blood cells and body structure, amplifies the signals and converts them to a 18bit digital signal.

The digital representation of the signal is presented to the mid processor section.

- PMP (PreAmplifier): The preamplifier amplifies 32 echo signals. The reception signals are sent to DFP.
- DFP (LB XP/XP PRO/XP Vet Front Processor): Convert the analog echo signal to digital.
- DTX (LB XP/XP PRO/XP Vet Transmission Board): This has 32 channel bipolar drivers.
- DCNN (LB XP/XP PRO/XP Vet Connection Board): This has 16 HV switch and 1 probe connector.

5-2-4 The Back End

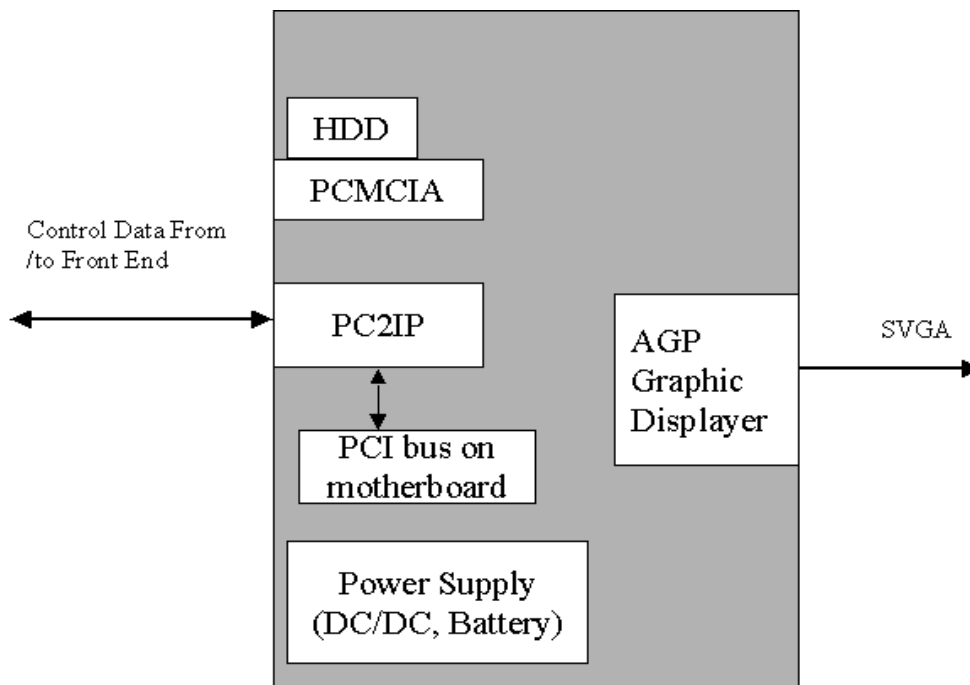

Figure 5-68 The back end

The Back End Processor grabs the data from the Image Port, stores it in a memory, performs scan conversion to pixel domain and drives the system LCD displayer.

Storing Devices:

Hard Disk Drive (HDD) (On the Back End Processor board)

PCMCIA memory card

5-2-5 Top Console

The Top Console includes a Standby/On switch, a keyboard, different controls for manipulating the picture quality, controls for use in Measure & Analyze (M&A), and loudspeakers for stereo sound output (used during Doppler* scanning).



NOTICE * This function is not available on Pro American Version.

5-2-6 External I/O

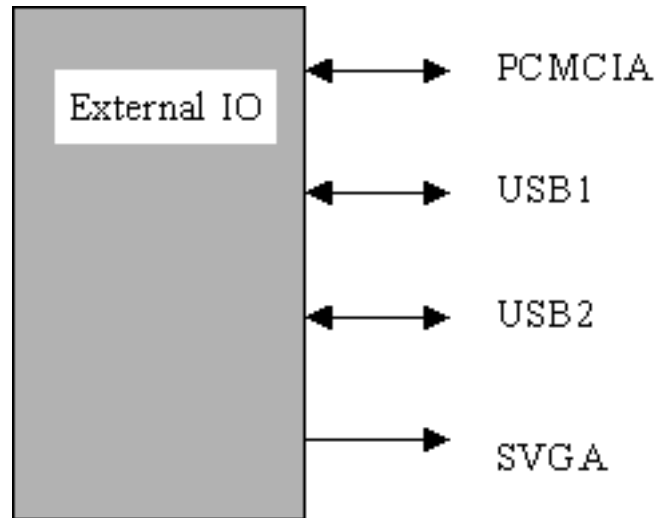

Figure 5-69 External I/O module overview

External I/O:

The external I/O is the interface between the scanner and all external items. Examples: wireless network, USB interface medical grade printer and external medical grade SVGA displayer.

5-2-7 Peripherals

CD-RW, and a Black & White Video Printer can be connected to the external I/O.

5-2-8 Wiring

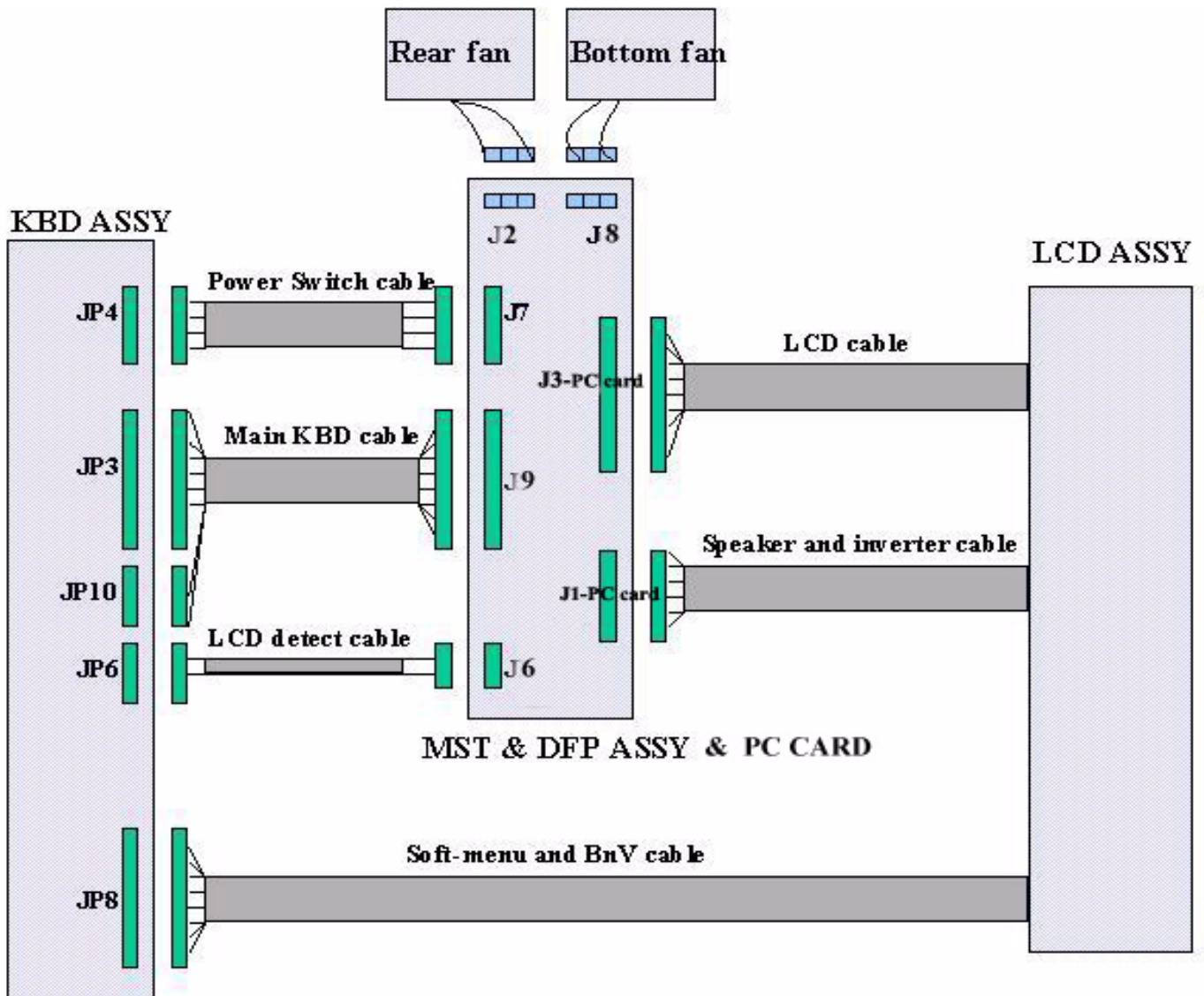

Figure 5-70 Wiring Diagram

- TGC: Time Gain Control
- A/N key: Alphabet and number key
- HDD: Harddisk
- DCNN: LB XP/XP PRO/XP Vet Connection board
- DTX: LB XP/XP PRO/XP Vet Transmit board
- DFP: LB XP/XP PRO/XP Vet Front end processing board
- MST: LB XP/XP PRO/XP Vet Master board
- PWR SW: Power Switch
- FPC: Flexible Print Circuit board
- PCMCIA card interface

Section 5-3 PWA (Printed Wire Assembly) Assy Diagrams

5-3-1 MST

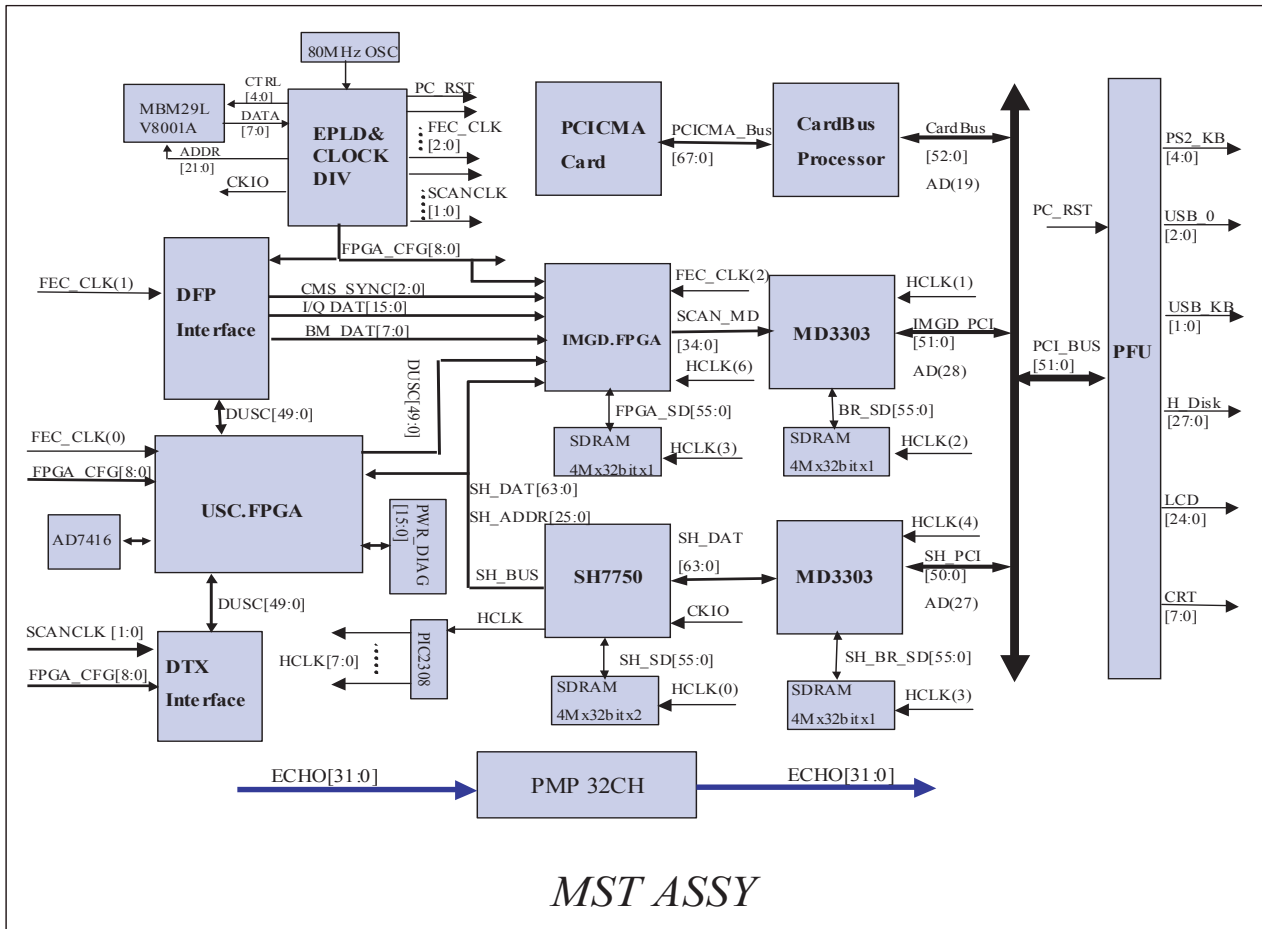

Figure 5-71 MST Block Diagram

- Flash: Flash memory
- EPLD: Programmable logic device
- SH4: Front controlling CPU
- Card_bus: PCI bridge located between PCMCIA card and PCI bus
- PWR_DIAG: Power diagnostic circuit
- PFU: Card CPU unit (700MHz)

5-3-1-1 Description

This diagram describes the MST board. It controls the front end of LOGIQ Book XP/XP PRO/XP Vet and also communicate with PC system through PCI interface.

The main function:

- Generate clock signal and distributing each clock signal.
- Generate DUSC bus cycle.
- Power diagnostics: HV, LV.
- Transmit image raw data (B/CFM*/DOP*) to PC after assembling packet including header information.

5-3-2 DFP

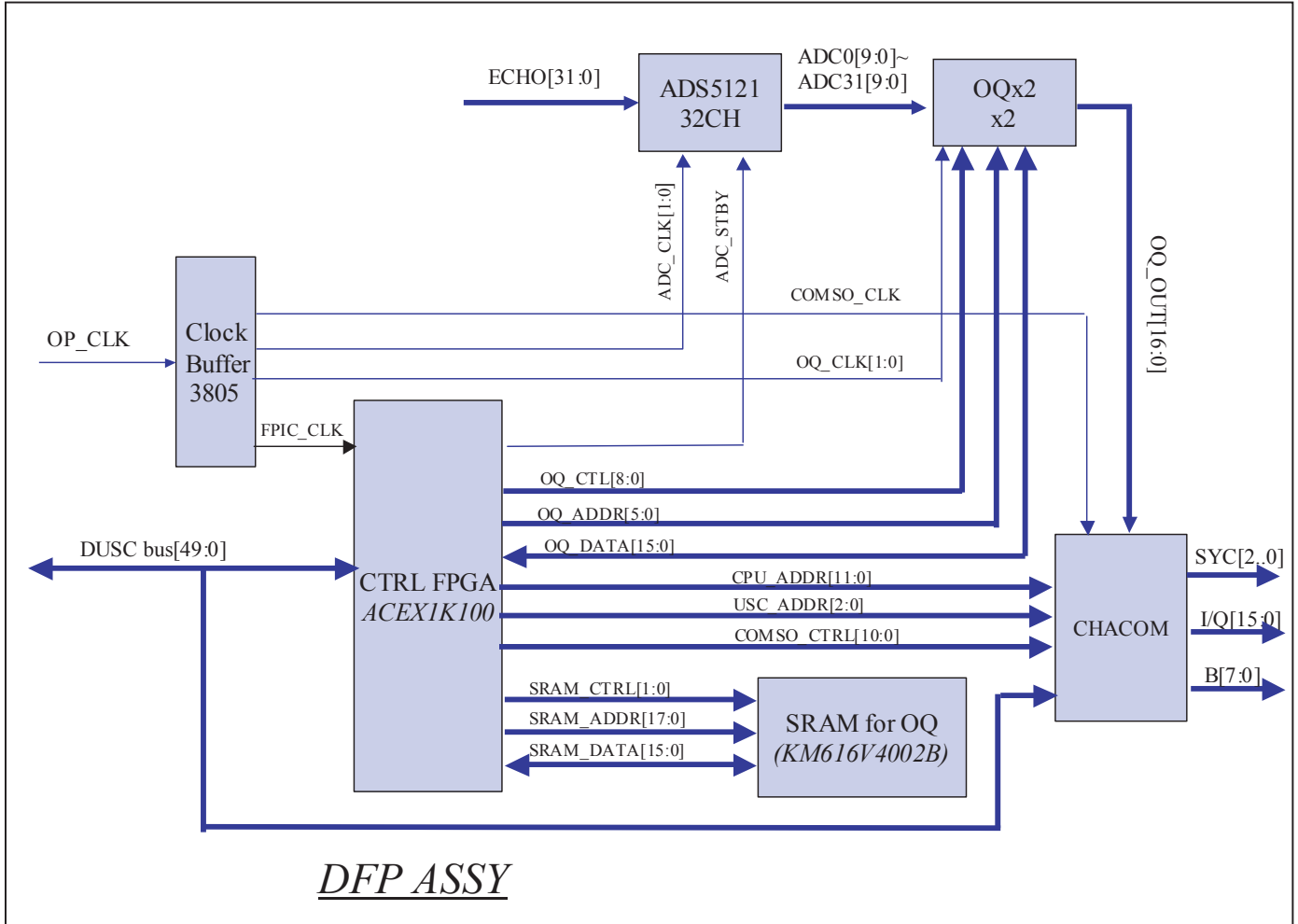

Figure 5-72 DFP Block Diagram

- DFP: LOGIQ Book XP/XP PRO/XP Vet Front End Processor board
- ADC: Analog/Digital converter
- OQX2: Beamform ASIC
- CHACOM: B/M/CFM*/Dop* signal processor ASIC
- FPIC FPGA: Front Process interface control



NOTICE * CF and Doppler mode are options on Vet and Pro American Version.

5-3-2-1 Description

This diagram describes the DFP (Front Process) board. It resides below MST board (located at the bottom layer).

The main function:

- Convertor 32 channels echo which is from preamp to digital signal.
- Focus the received RF signals by digital beamforming technology.
- Control CHACOM to acquire optimum image data.

5-3-3 DTX

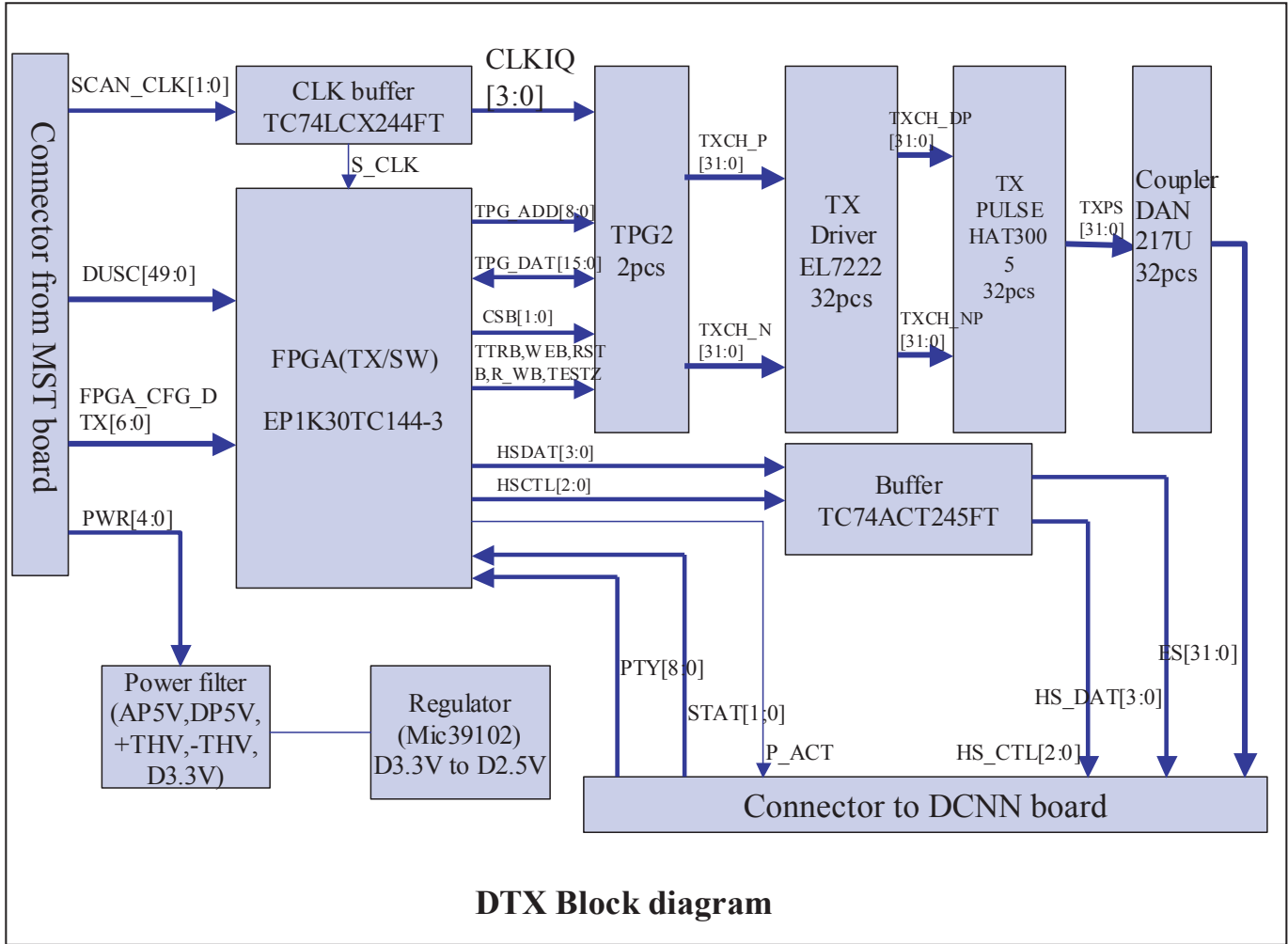

Figure 5-73 DTX Block Diagram

- DTX: LB XP/XP PRO/XP Vet Transmit board
- TPG2: Transmit Pulse Generator
- DCNN: LB XP/XP/XP Vet PRO Connection board
- MST: LB XP/XP PRO/XP Vet Master board
- TXMX FPGA: Transmit and MUX controlling FPGA

5-3-3-1 Description

This diagram describes LOGIQ Book XP/XP PRO/XP Vet DTX board, it resides between MST board and DCNN board.

The main function:

- Generate the transmit pulse.
- Drive the Tx pulse with high voltage.

5-3-4 DCNN

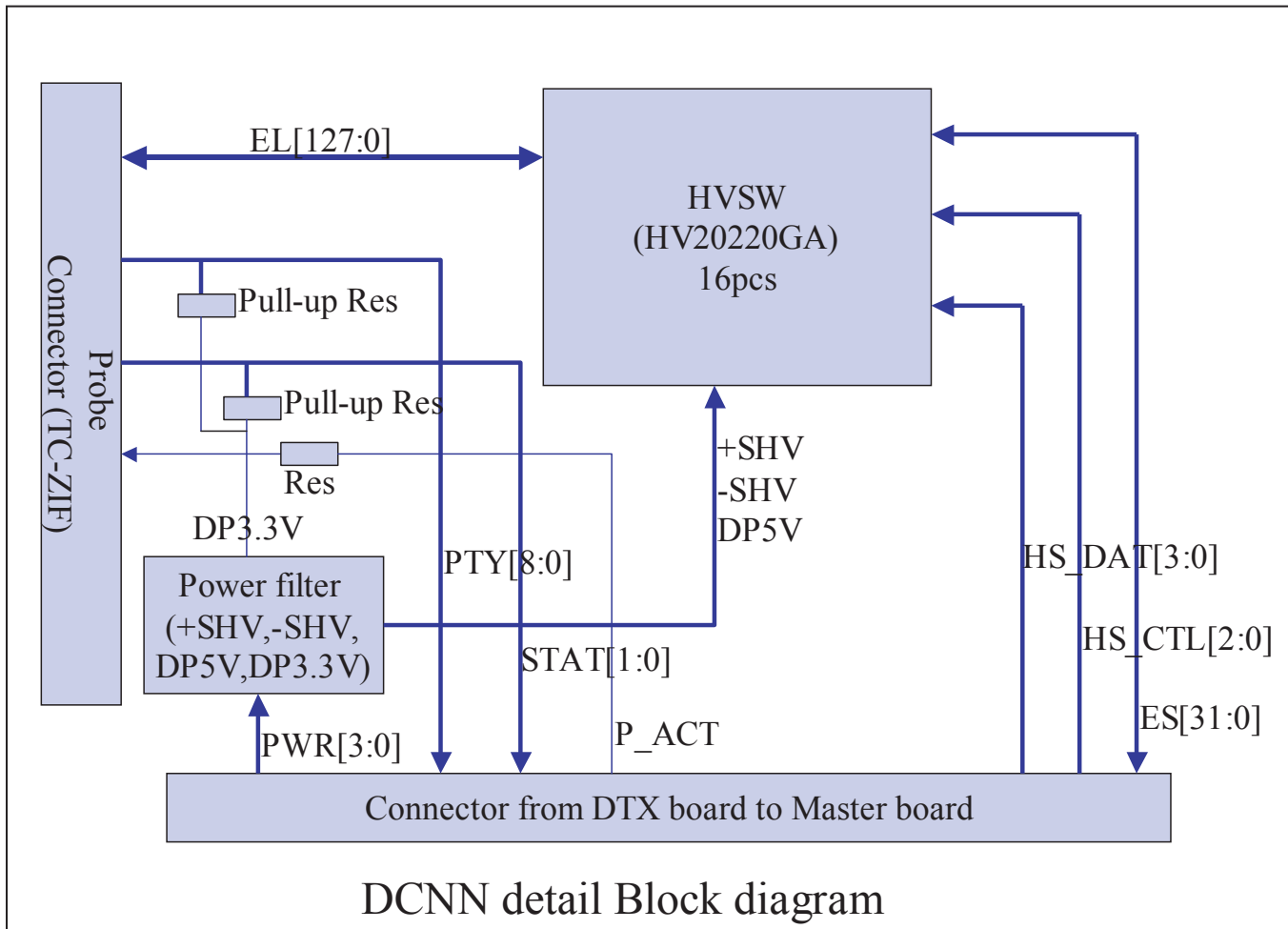

Figure 5-74 DCNN Block Diagram

- DCNN: LB XP/XP PRO/XP Vet Connection board
- HV SW: High Voltage Switch
- DTX: LB XP/XP PRO/XP Vet Transmit board

5-3-4-1 Description

This diagram describe LOGIQ Book XP/XP PRO/XP Vet probe connection board. The board resides besides DFP, MST and DTX board.

The main function:

- Make the interface connection between the probe and internal ultrasound system.
- The high voltage switches on this board approach the beam scanning.

5-3-5 Keyboard

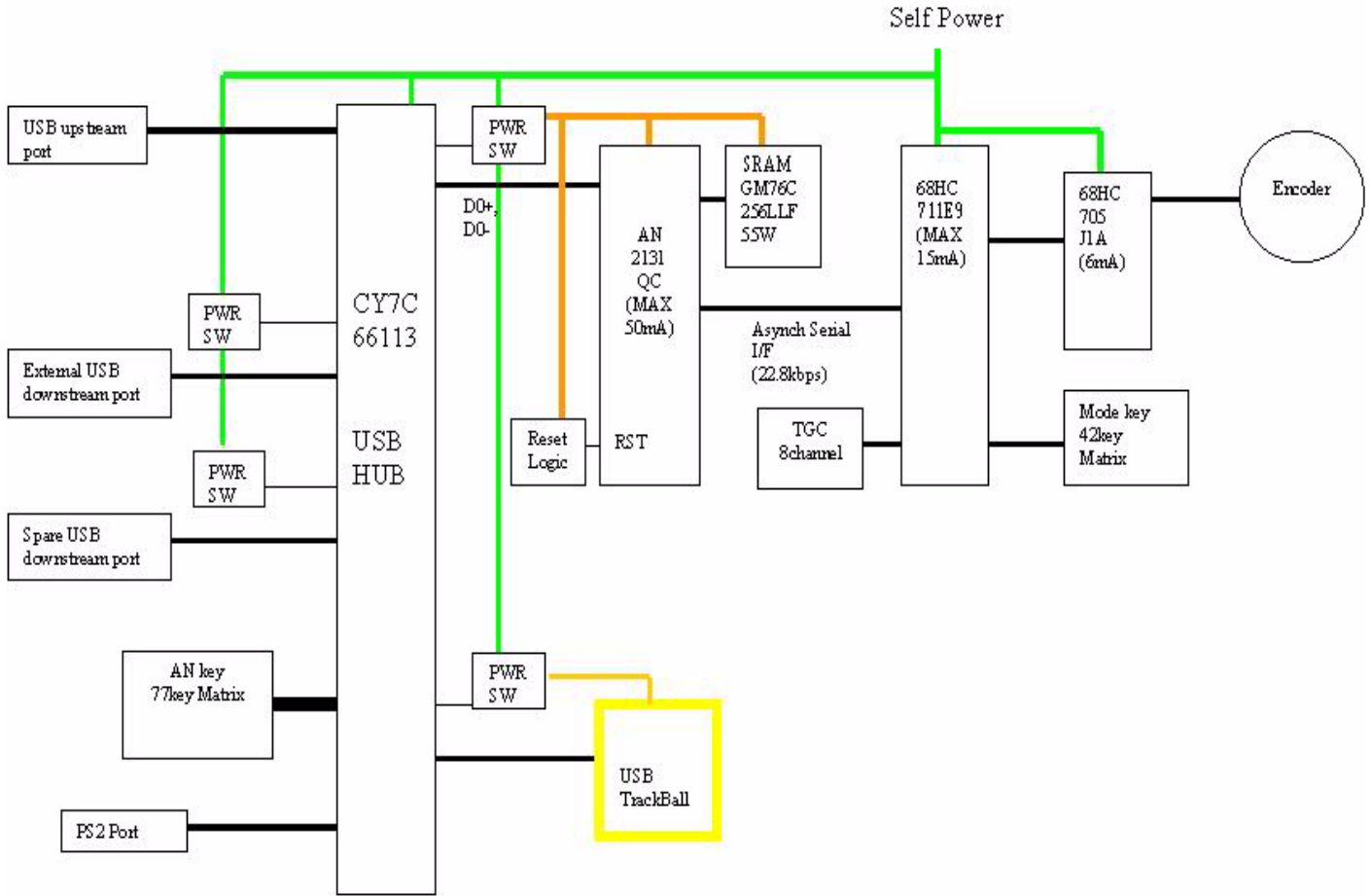

Figure 5-75 Keyboard Block Diagram

5-3-5-1 Scan Control Board LEDs

Table 5-40 LED Indications

Function Module	LED Location	LED Color	LED Function
Control panel	1st from left	Green	HDD activity
	2nd	Green	Main Power activity
	3rd	Green/Orange	Green indicates battery charging. Orange indicates battery is low
	4rd	Off	Unused
MST	DS3	Red	3.3V power
	DS1	Red	SH4 status: HH: Reset HL: Standby LH: Sleep LL: Normal operation
	DS2	Red	
DFP	DS1	Red	Unused
DTX	DS1	Red	Unused

Section 5-4 Power Diagrams

5-4-1 Overview

The AC Power assy's main tasks are to isolate and output to the DC/DC unit which is inside the system console. The input of AC power pack will be the AC outlet and it's universal, the range is AC 90V-264V, 47-63Hz. And no main power switch located on this power pack.

5-4-2 AC Power

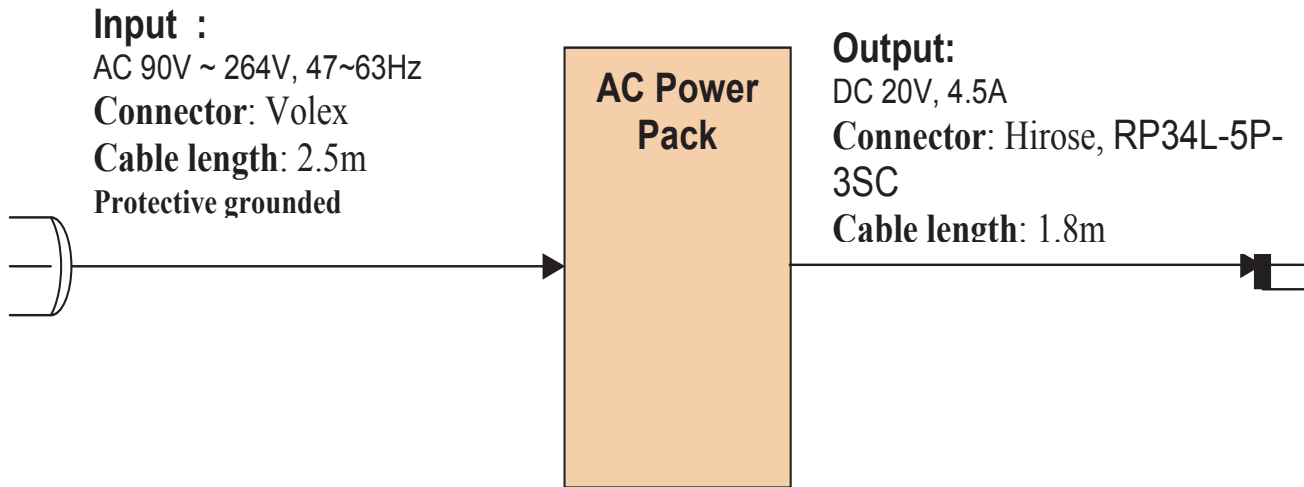

Figure 5-76 AC Power Distribution Block Diagram

The mains cord has plugs in one side end. A male plug connects to the mains outlet on site.

The mains voltage is routed to the AC power pack through a Circuit Breaker located on the site.

The Circuit Breaker is of the auto fuse type, if for some reason the current grows to high, the switch will automatically break the power.

From the Main Circuit Breaker, the AC power is routed via an Inrush Current Limiter to a internal outlet connector for the Mains Transformer.

5-4-3 DC Power (Low Voltage)

The DC/DC power supply unit will use the output of AC pack or the battery as input, to generate various voltage, such as +3.3V, +5V, -5V, +12V, +THV, -THV, +SHV and -SHV, which are necessary for the system.

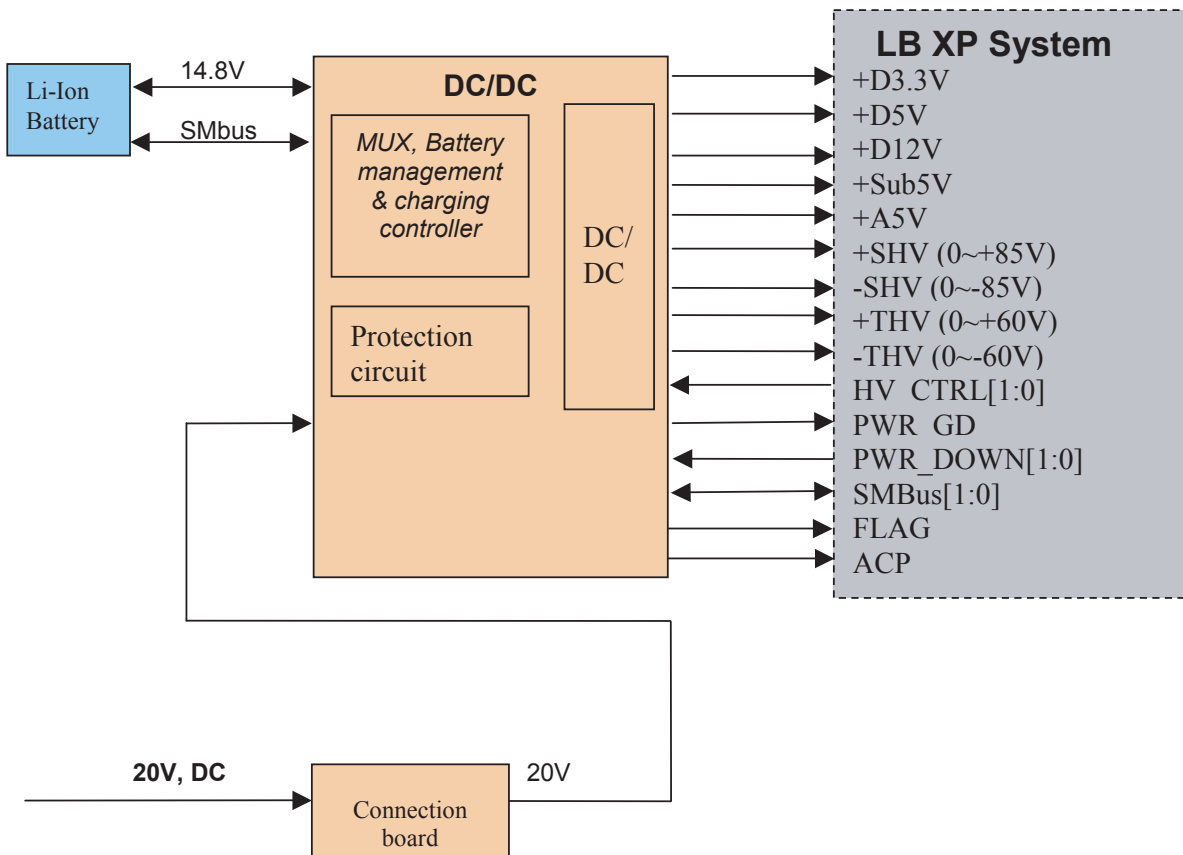

Figure 5-77 DC Power Distribution Block Diagram

DC Output Capacity:

- +3.3V, 5.5A
- +D5V, 1.4A
- +A5V, 1.9A
- +12V, 1.4A
- SUB5V, 0.1A
- +SHV, 0.2W
- -SHV, 0.2W
- +THV, 4W
- -THV, 4W

5-4-4 Battery charging

The charging circuit is lithium-Ion battery charge and discharge controller. This block can switch the power between the battery and the output of AC Pack. If the output of AC Pack is available, the power input of DC/DC Unit should be from the AC Pack and the battery will be charged if it's not full. This block will be also in charge of the battery charging monitor to avoid the battery over heat and over charging, charging will be shut off automatically if battery is charged fully. The battery will discharge to provide the power to the system when out of AC power pack output or AC line.

5-4-5 Rear Panel

Block Diagram

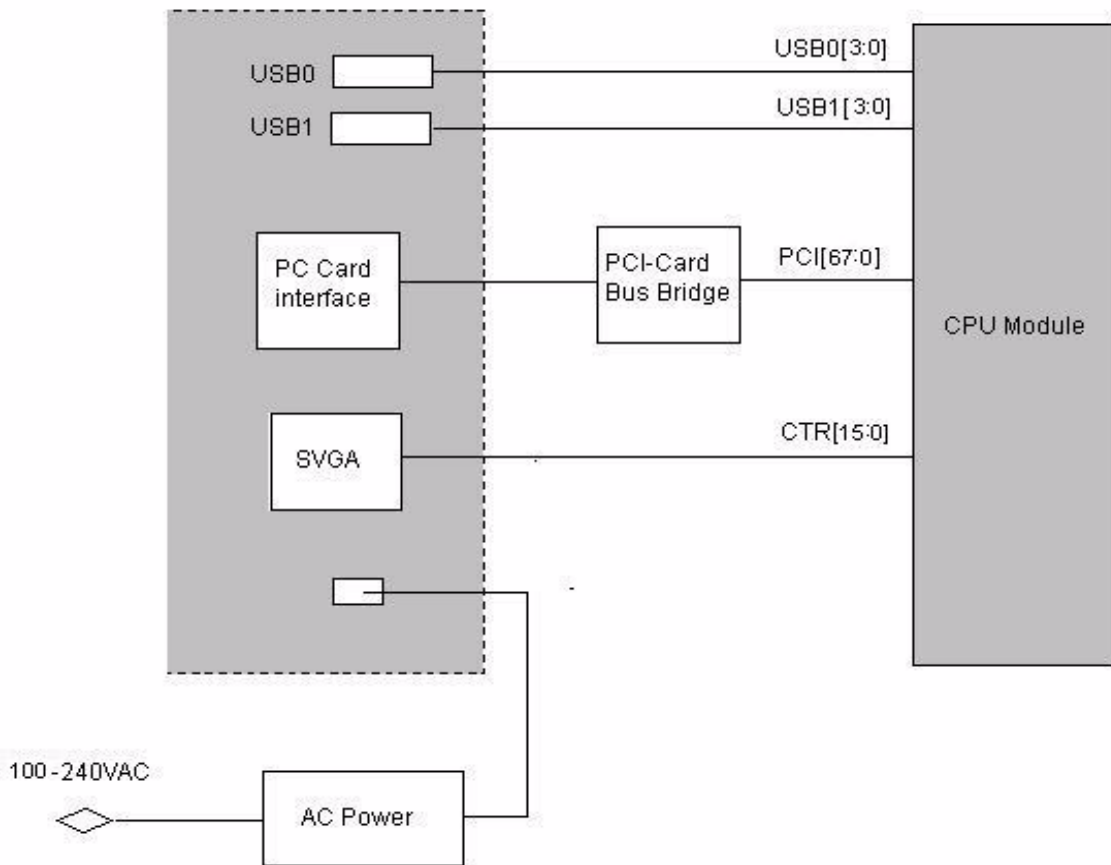

Figure 5-78 Rear Panel Block Diagram

DC power input and some signals interface are located on rear panel. The range of DC input is 20V, 3.5A. And the USB, PC card interface can be used to connect peripheral device. SVGA interface can be used to connect an additional monitor.

5-4-6 Air Flow Distribution

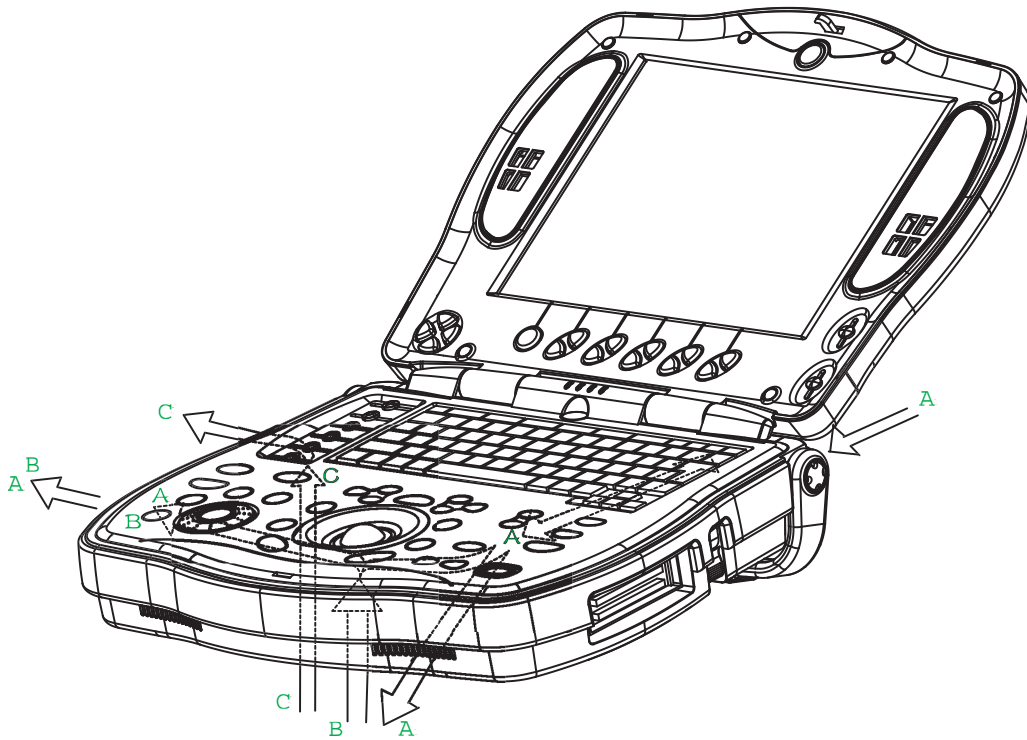

Figure 5-79 Air Flow Inside the Scanner

The three air flow passes allow the scanner to be cooled down as shown in the figure above.

- Pass A (Rear Fan> MST, DFP Assy> Bottom front/Bottom left) for MST, DFP Assy cooling.
- Pass B (Bottom> Bottom Fan> DCDC> Bottom left) for DCDC cooling.
- Pass C (Bottom> CPU Fan> Bottom left) for CPU cooling.

5-4-7 Fans

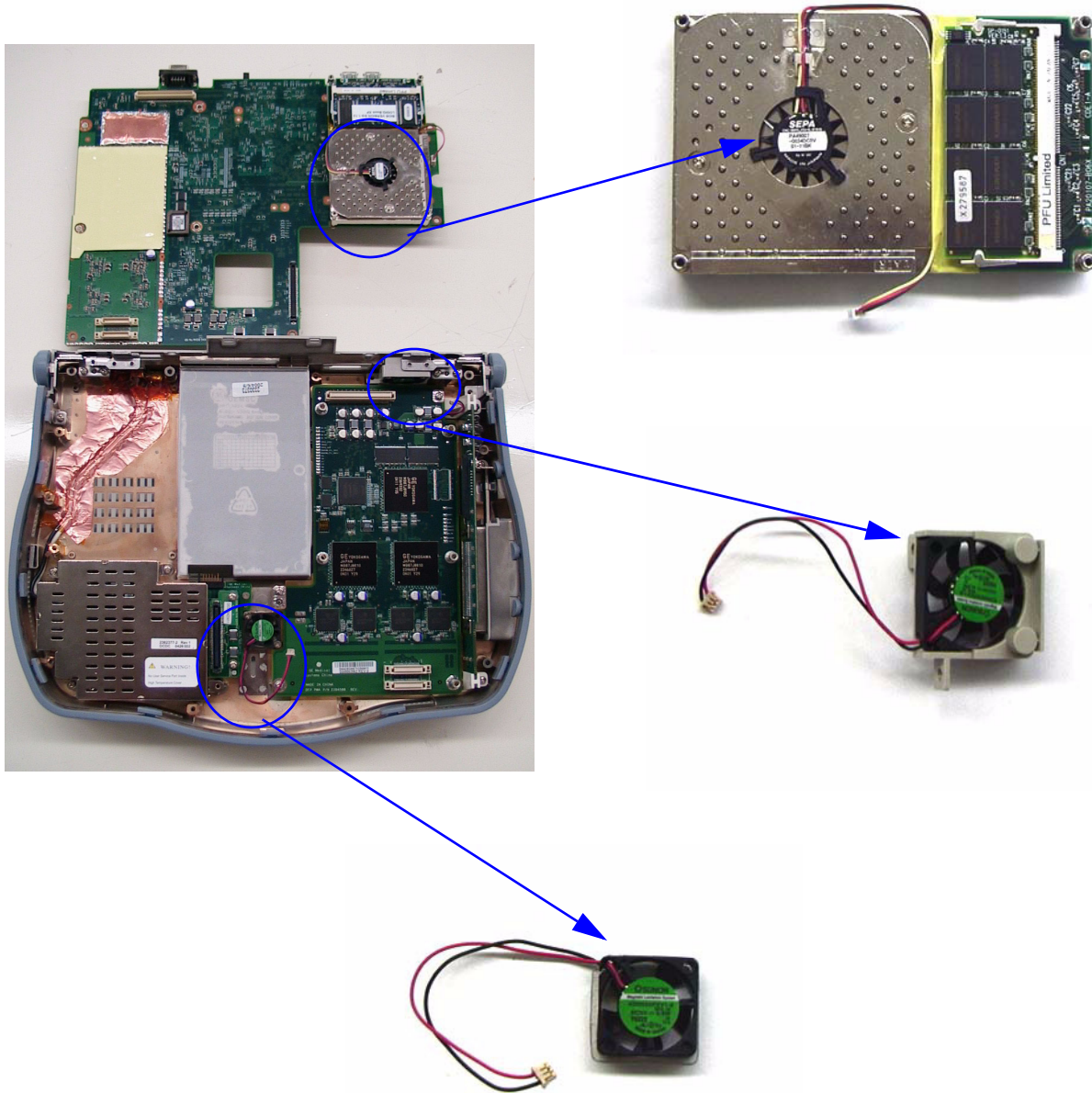

Figure 5-80 Fans

The scanner contains the eight fans at the following positions for producing an air flow.

- One fan: Inside the CPU for air flow pass C
- One fan: On the Rear for air flow pass A
- One fan: On the Bottom for air flow pass B

Section 5-5 Common Service Platform

5-5-1 Introduction

The Service Platform contains a set of software modules that are common to all PC backend ultrasound and cardiology systems. The Common Service Platform will increase service productivity and reduce training and service costs.

5-5-2 Global Service User Interface (GSUI)

5-5-2-1 Internationalization

The user interface provided by the service platform is designed for GE personnel and as such is in English only. There is no multi-lingual capability built into the Service Interface.

5-5-2-2 Service Login

Select Service Platform from Start menu.

This menu links the user to the service login screen.

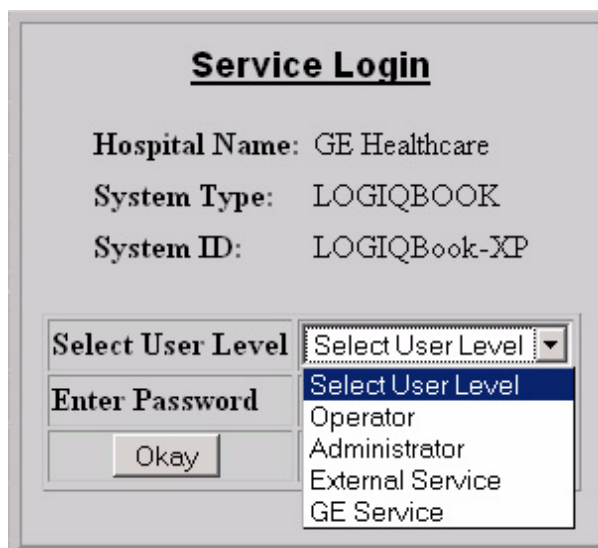

Figure 5-81 Service Login Screen

5-5-2-3 Access / Security

The service interface has different access and security user levels. Each user is only granted access to the tools that are authorized for their use.

5-5-2 Global Service User Interface (GSUI) (cont'd)

Table 5-41 Service Login User Levels

User Level	Access Authorization	Password
Operator	Authorized access to specified diagnostics, error logs and utilities. Same acquisition diagnostic tests as GE Service.	uls
Administrator		uls
External Service		gogems

Every access request, whether successful or not, will be logged into a service access log that is viewable to authorized users.

5-5-2-4 The usage for security cable

The ultrasound system equipped with Kensington security slot which is compatible with a Kensington security cable, refer to [Figure 5-82 on page 24](#) .



Figure 5-82

How to prevent unauthorized removal of the ultrasound system?

- 1.) Wrap the cable around the immovable object, refer to [Figure 5-83 on page 24](#) ;
- 2.) Make sure and rotate the key to the right (unlocked position);
- 3.) Insert the lock into the Kensington security slot in the system side cover, refer to [Figure 5-83](#);
- 4.) Rotate the key to the left (locked position).
- 5.) For more information, visit www.kensington.com.



Figure 5-83

5-5-3 Service Home Page

The navigation bar at the top of the screen allows the user to select from several tools and utilities.

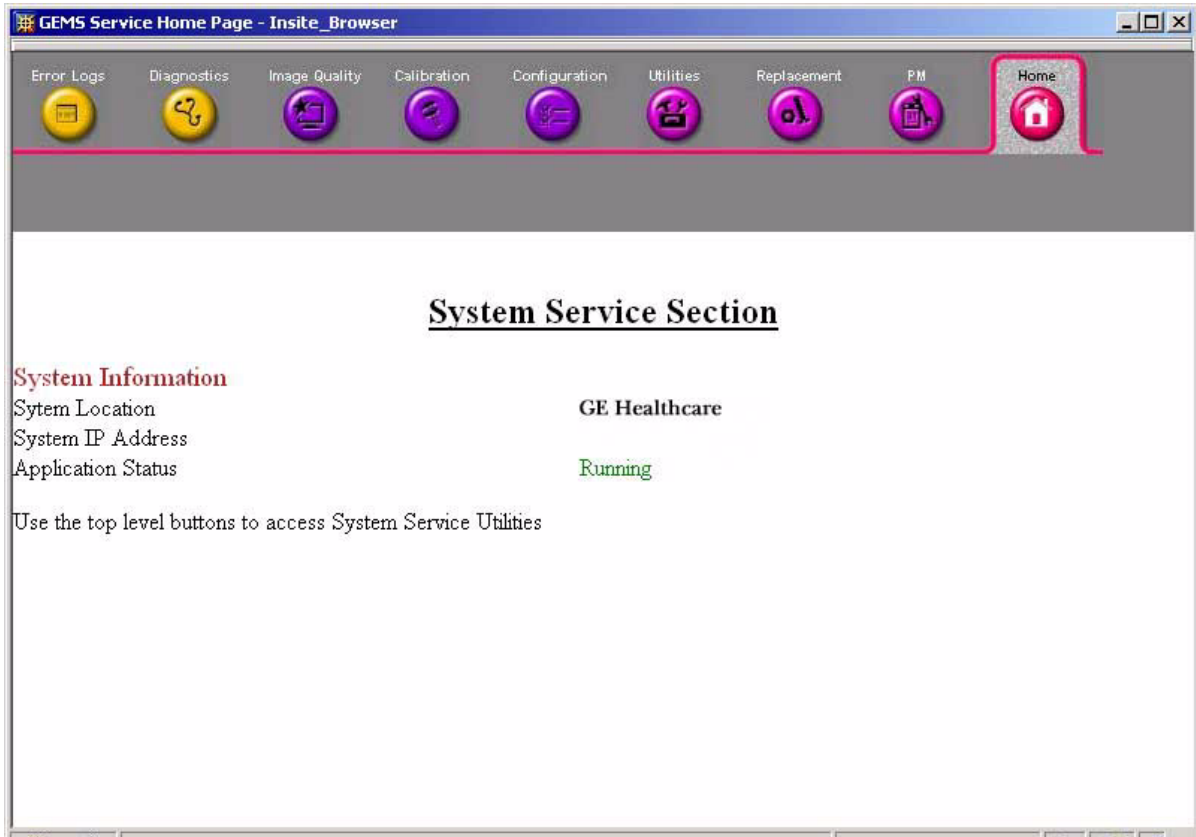

Figure 5-84 Customer Service Home Page

5-5-4 Error Logs Tab (Not available on LOGIQ Book XP/XP PRO/XP Vet now)

From the Error Logs Tab the Log Viewer displays four categories with pull-down sub-menus and an Exit selection. The Service Interface allows scanner logs to be viewed by all service users.

The **Filter** Error log is not available to customer level analysis.

The log entries are color-coded to identify the error level severity at a glance.

Table 5-42 Log Entry Key

Severity	Error Level	Color Code
1	Information	Green
2	Warning	Blue
3	Error	Red

The Service Interface supports the transfer of these logs to local destinations such as the CD-ROM drive.

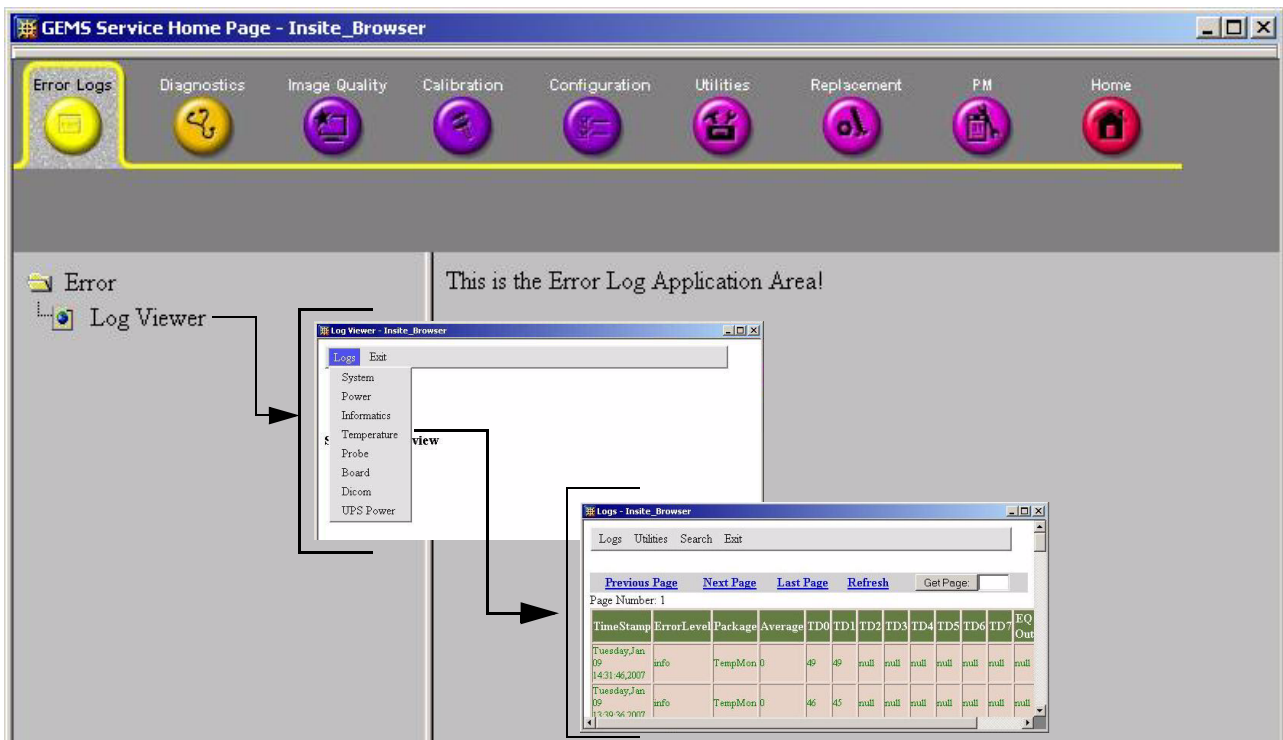

Figure 5-85 Log Viewer / Logs / Log Entries

5-5-4-1 Logs

The seven sub-menus of the Logs category are System, Power, Infomatics, Temperature, Probe, Board, and DICOM*.

NOTE: [Figure 5-85](#) provides a graphical example of the log entries for the **System Logs**.

Log table headings for the different logs are as follows:

- **System**
Log entry headings include Time Stamp; Error Level; Package; and Error Message.
- **Power**
Log entry headings include Time Stamp; Error Level; Package; and Error Message.
- **Infomatics**
Log entry headings include TimeStamp, Revision, PtID, PtDOB, PtSex, PtWeight, PtHeight, ExamID, Exam Category, ExamCurDate, and ExamStartTime.
- **Temperature**
Log entry headings include Time Stamp; Error Level; Package; Upper FEC Sensor; and Lower FEC Sensor.
- **Probe**
Log entry headings include Time Stamp; Error Level; Package; Error Message; Severity; Revision; and three (3) new labels that have not yet been named.
- **Board**
Log entry headings include Time Stamp; Error Level; Package; Board; Severity; and two (2) new labels that have yet been named.
- **DICOM***
Log entry headings include Time Stamp; Error Level; Package; and Error Message.



NOTICE * This function is not available on Pro American Version.

5-5-4-2 Utilities

The two sub-menus of the **Utilities** category are Plot Log, and Plot Page.

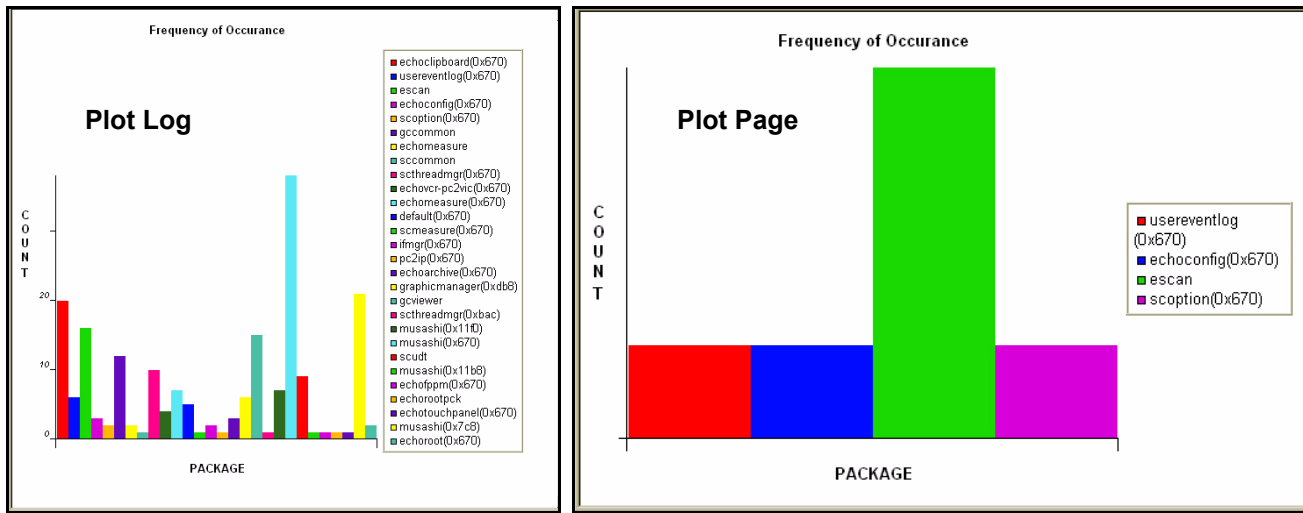

Figure 5-86 Utilities Sub-Menus

- **Plot Log**
Allows for the color coded plot of all Log contents with the package on the 'x' axis and incident count on the 'y' axis.
- **Plot Page**
Allows for the color coded plot of all Page contents with the package on the 'x' axis and incident count on the 'y' axis.

5-5-4-3 Search

On the Text Search sub-menu of the **Search** category, user can select **Text Search**, then enter case-sensitive text they wish to find. This filter field works well for filtering the Sys log file for the word "fail".

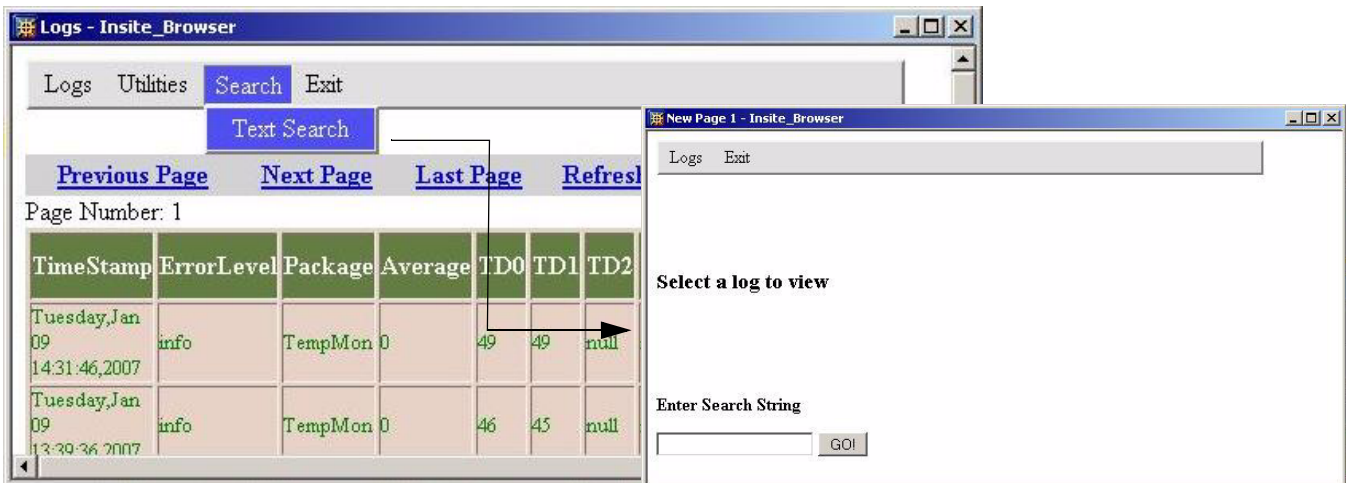

Figure 5-87 Search Sub-Menu

5-5-4-4 Exit

The sub-menu, **Exit Log Viewer**, returns the user to the Service Desktop home page.

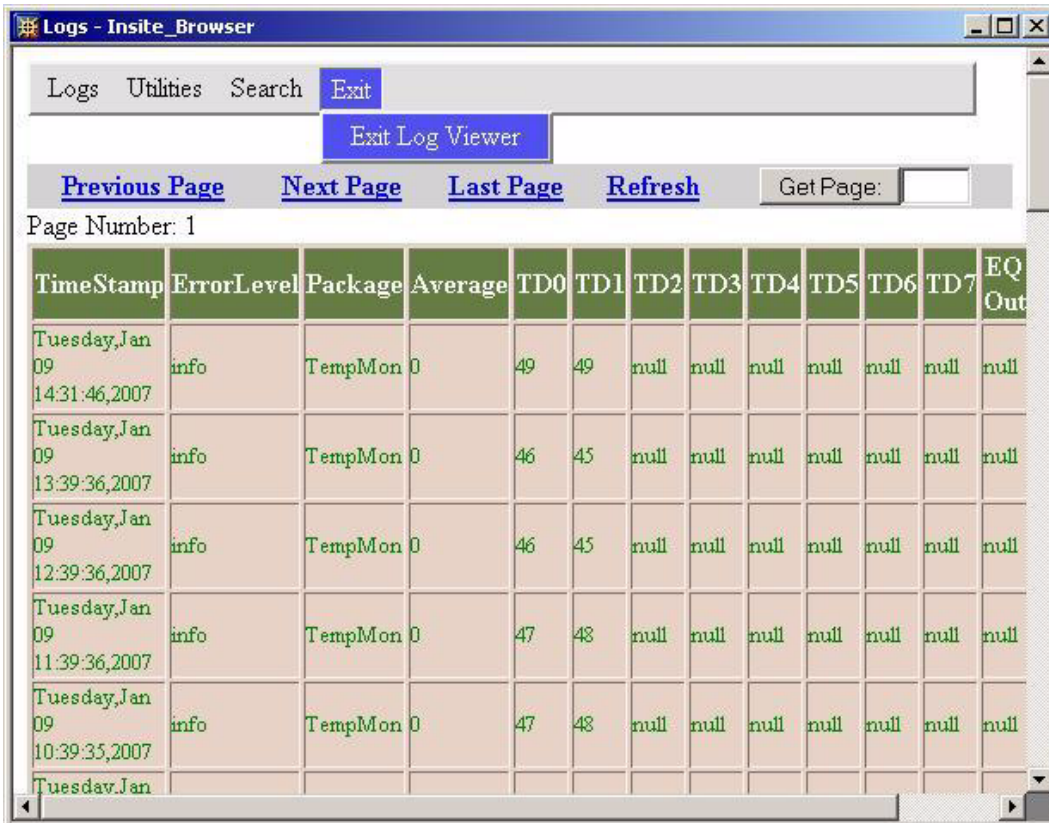

Figure 5-88 Exit Log Sub-Menu

5-5-5 Diagnostics

Detailed **Diagnostic** information is found in [Chapter 7](#).

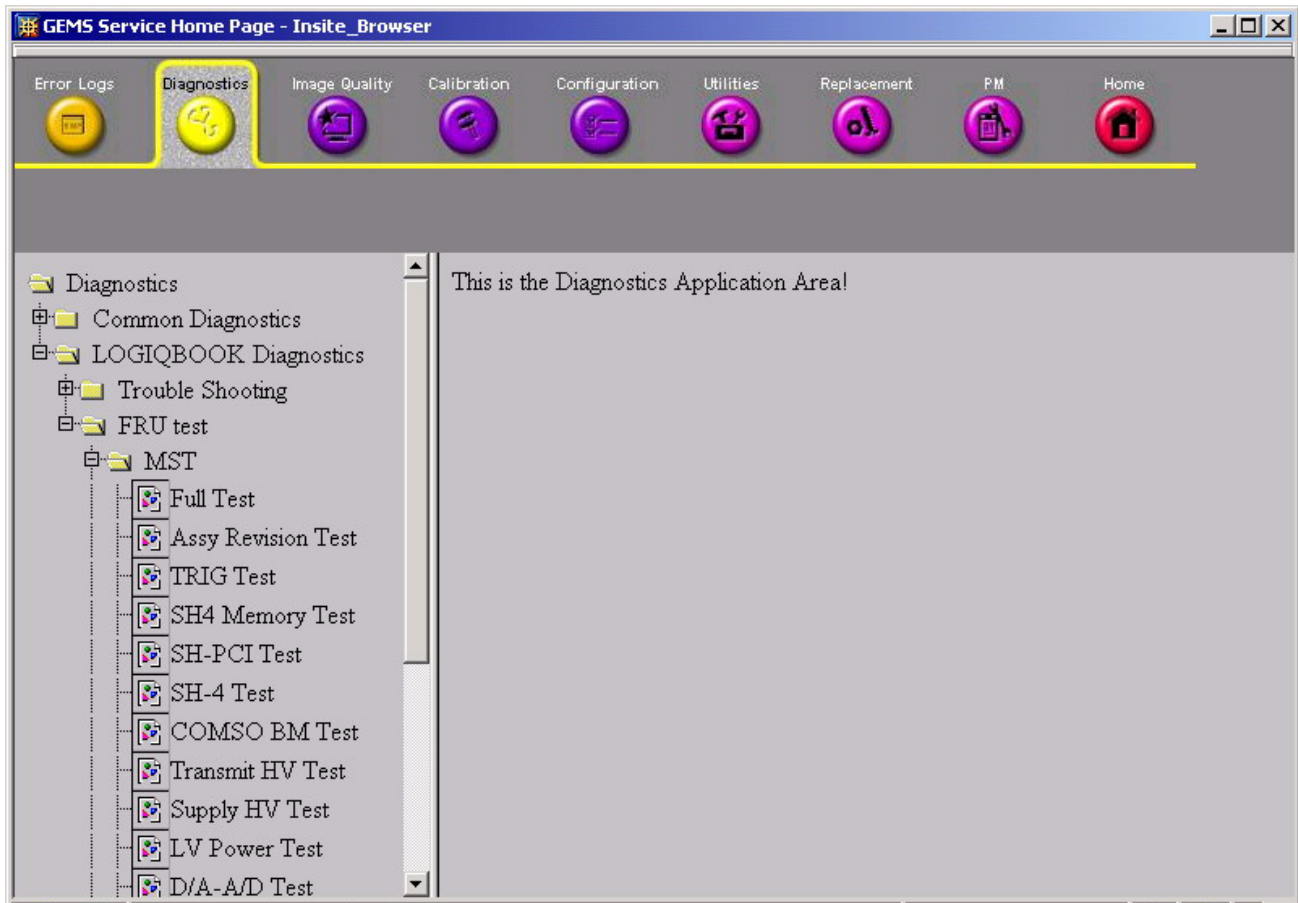

Figure 5-89 User Diagnostic Page

5-5-5-1 Diagnostics Execution

Diagnostic tests are executable by both local and remote users. The Service Platform provides top-level diagnostic selection based on the user's level and login access permissions. Remote access will require disruptive diagnostic permissions to run Acquisition diagnostics.

5-5-5-2 Diagnostic Reports

Diagnostic tests return a report to the Service Platform. The platform retains the report and allows for future viewing of the diagnostic logs.

5-5-6 Image Quality

The **Image Quality** page is intended to contain tools for troubleshooting image quality issues.

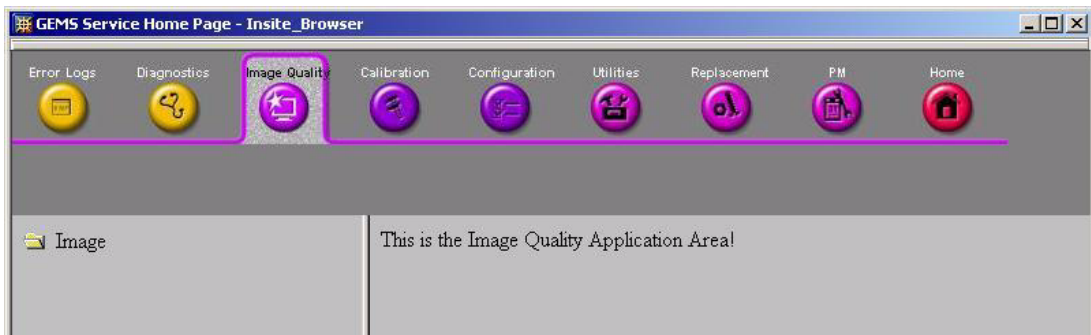

Figure 5-90 Image Quality Page

5-5-7 Calibration

The **Calibration** page is intended to contain the tools used to calibrate the system.

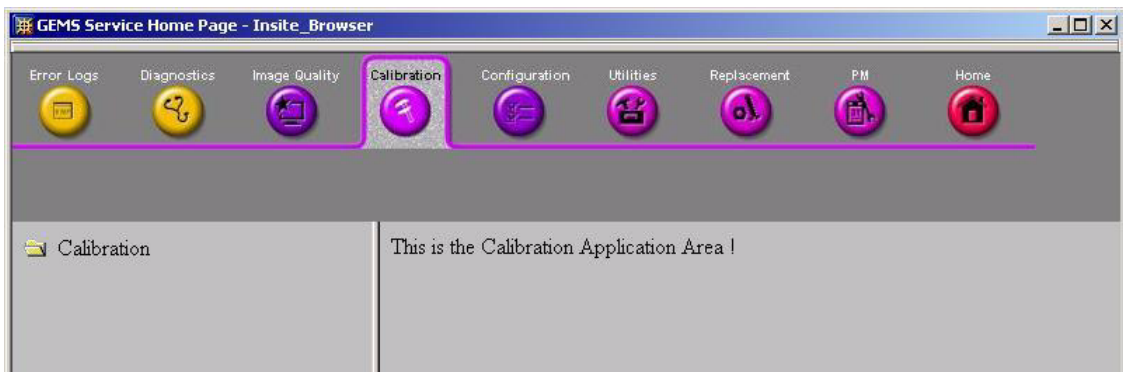

Figure 5-91 Calibration Page

5-5-8 Configuration

The **Configuration** page is intended to be used to setup various configuration files on the system.

The Service Platform is the access and authorization control for remote access to the configuration subsystem.

The enable/disable of software options can be done from this Configuration page.

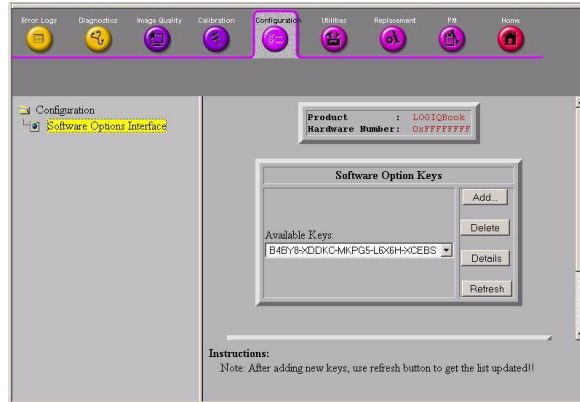

Figure 5-92 Configuration Page

5-5-9 Utilities

The **Utilities** page contains several miscellaneous tools.

5-5-10 Replacement

The **Replacement** page is intended to contain the tools used to track replacement parts used in the system.



Figure 5-93 Part Replacement Page

5-5-11 PM

The **PM** page is intended to contain the tools used in periodic maintenance of the system.

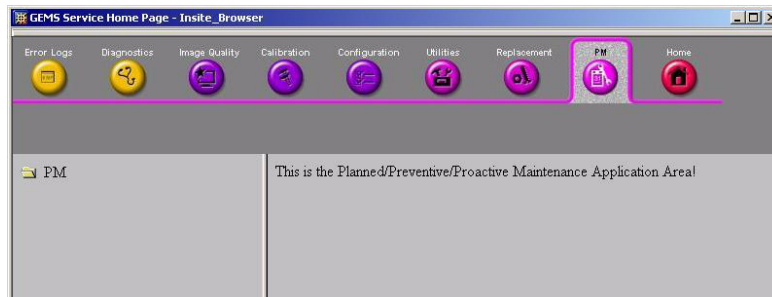

Figure 5-94 Planned Maintenance Page

This page was intentionally left blank.

Chapter 6

Service Adjustments

Section 6-1 Overview

6-1-1 Purpose of this chapter 6

This section describes how to test and adjust the scanner. These tests are optional. You may use them to check the system for errors.

Table 6-43 Contents in chapter

Section	Description	Page Number
6-1	Overview	6-1
6-2	Monitor Adjustments	6-2

Section 6-2 Monitor Adjustments

6-2-1 Adjustments Procedures

To adjust the brightness:

- 1.) Adjust the LCD monitor's toggle, located beside the Primary and Secondary Control (on the right side of the LCD Monitor).



Figure 6-95 LCD Monitor

Chapter 7

Diagnostics/Troubleshooting

Section 7-1 Overview

7-1-1 Purpose of Chapter 7

This section describes how to setup and run the tools and software that help maintain image quality and system operation. Very basic host, system and board level diagnostics are run whenever power is applied. Some Service Tools may be run at the application level. However most software tests are required.

Table 7-44 Contents in Chapter 7

Section	Description	Page Number
7-1	Overview	7-1
7-2	Gathering Trouble Data	7-2
7-3	Screen Captures	7-4
7-4	Global Service User Interface (GSUI)	7-8
7-5	Common Diagnostics	7-17
7-6	LOGIQ Book XP/XP PRO/XP Vet Diagnostic Descriptions	7-19

Section 7-2 Gathering Trouble Data

7-2-1 Overview

There may be a time when it would be advantageous to capture trouble images and system data (logs) for acquisition to be sent back to the manufacturer for analysis. There are different options to acquire this data that would give different results.

7-2-2 Collect Vital System Information

The following information is necessary in order to properly analyze data or images being reported as a malfunction or being returned to the manufacturer:

- Product Name = LOGIQ Book XP/XP PRO/XP Vet

From the *Utility>System>General>About* screen:

Applications Software

- Software Version
- Software Part Number

System Image Software

- Image Revision
- Image Part Number

7-2-3 Collect a Trouble Image with Logs

If the system should malfunction, press the Alt-D keys simultaneously. This will collect a screen capture of the image monitor, system presets and the following logs:

- Keyboard Shadow Log
- Error Logs
- Crash Log
- Power Supply
- Temperature

NOTE: *Power Supply and Temperature logs are not currently being updated by the LOGIQ Book XP/XP PRO/XP Vet.*

This Alt-D function is available at all times.

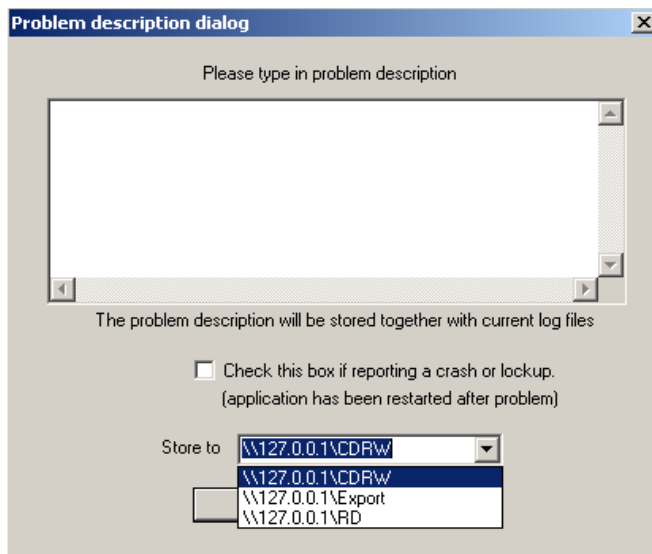

Figure 7-96 ALT-D Dialog Box

When Alt-D is pressed, a menu box appears that allows for:

- A place to enter a description of the problem
- A choice to store to a pre-formatted CD-R, RD (Removable Disk) or to the *Export* directory E: drive.

The subsequent file is compressed and time stamped. The screen capture is a bitmap which eliminates the possibility of artifacts from compression.

Section 7-3 Screen Captures

There may be times when the customer or field engineer will want to capture a presentation on the screen. This is accomplished by first saving the image(s) to the clipboard using a Print Key.

The P3 key is the factory default print key to accomplish a secondary screen capture. However, the default is for the video area only or the customer may have customized the P3 Key function. Therefore, screen capture should involve the following steps:

- 1.) Check and record any custom settings for the Print3 button.
- 2.) Set the Print3 button to Whole Screen, Secondary Capture.
- 3.) Capture the required screens to the Hard Drive or CD-R.
- 4.) Restore the Print3 button to it's original settings.

7-3-1 Check and Record the P3 Key Function

Check the function of the Print 3 Key in the event that the customer may have made some custom settings.

- 1.) Click *Utility* on the keyboard.
- 2.) Select *Advanced>Connectivity* from the Utilities Menu.
- 3.) Select the *Buttons* tab on the Connectivity screen.
- 4.) In the *Button* field, select Print3.

The Connectivity/Buttons Screen will be displayed like the one shown in [Figure 7-97 on page 7-4](#) .

Name	Type	Destination De...	Dir
CopyToWflow_01	Image To Buffer	MyComputer	Out

Figure 7-97 Buttons Set Up Screen

P3 is the factory default Screen Capture Key. If it is not set to Whole Screen or Screen Capture, as shown in [Figure 7-97](#), proceed to step 5 to record the customer's custom settings.

7-3-1 Check and Record the P3 Key Function (cont'd)

- 5.) In the *Destinations* section, record the service that is displayed. The destinations list displays the following information:
 - * Name: user defined during service configuration
 - * Type: the type of service
 - * Destination Device: the device for which the service was configured
 - * Dir: direction: output, input, or both (I+O)
- 6.) In the *Image generated* section, record the parameters related to the service.

7-3-2 Setting the P3 Key to Screen Capture

If the P3 Key is not set to screen capture:

- 1.) While on the Connectivity screen, with the Buttons tab displayed, go to the drop down selection menu in the *Destinations* section.
- 2.) From the drop down menu select *CopyToWflow_01>Image to Buffer>MyComputer>Out*.
- 3.) Ensure that the *Image generated* section for capture Area is set to Whole Screen, secondary Capture and No Image Compression.
- 4.) The P3 Key should now be set up for whole screen capture, sending the screens to the image buffer (clipboard).

7-3-3 Capturing a Screen

The following is a generic process to capture any screen from the scanner:

- 1.) Navigate to and display the image/screen to be captured.
- 2.) Press **P3**. This will place a snapshot of the screen on the "clipboard" displayed at the bottom of the scan image display.

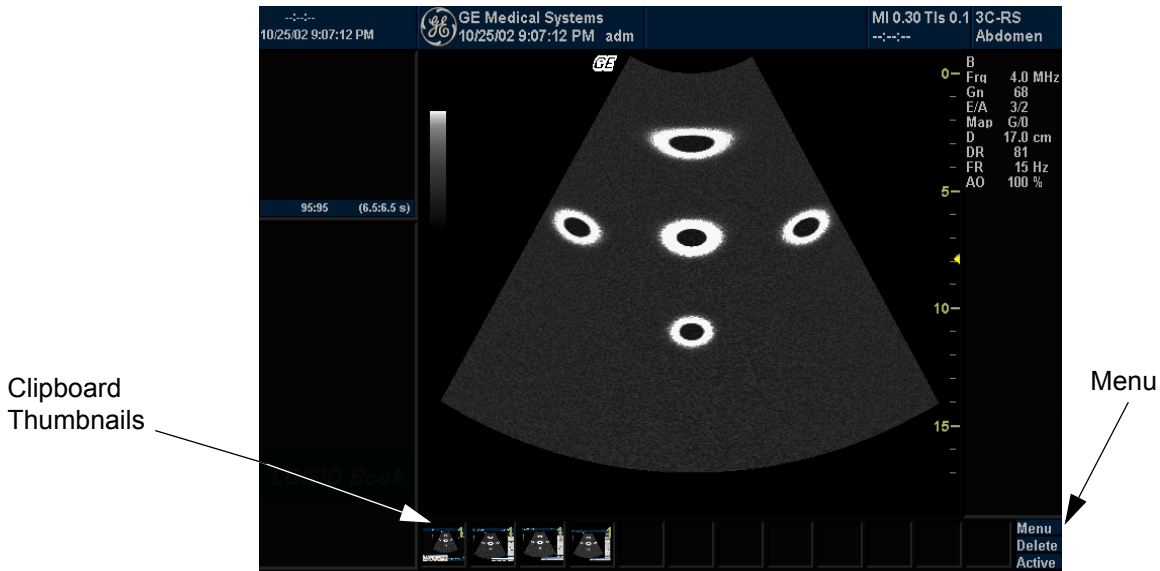

Figure 7-98 Select Image to Capture

- 3.) Click **FREEZE** to unfreeze the image to view the image screen and the snapshots displayed on the bottom.
- 4.) Highlight the snapshot to be stored to the system RD (Removable Disk) or CD-R.
- 5.) Select Menu on the right side of the image screen, then highlight and select **SAVE AS**.



Figure 7-99 Menu > Save As

7-3-3 Capturing a Screen (cont'd)

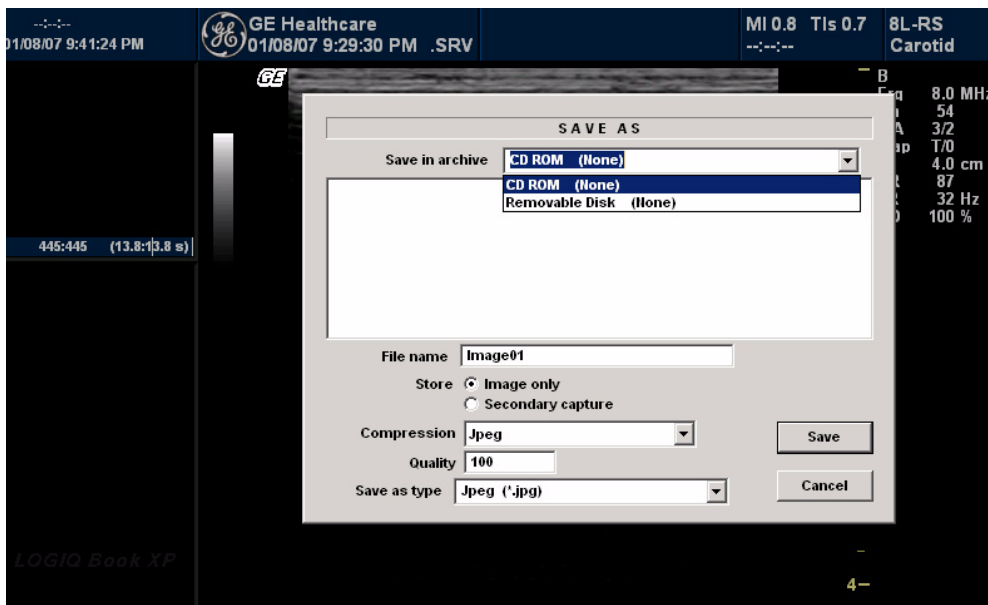

Figure 7-100 Save Dialog Box

6.) A Save dialog box will be opened. Save the image on the Removable disk or CD-R.

7-3-4 Reset the P3 Key to Customer's Functionality

If the customer had programmed the P3 Key to a function other than screen capture, restore that functionality recorded in [section 7-3-1 on page 4](#). Refer to [Figure 7-97](#).

- 1.) Click *Utility* on the keyboard.
- 2.) Select *Advanced>Connectivity* from the Utilities Menu.
- 3.) Select the *Buttons* tab on the Connectivity screen.
- 4.) In the *Button* field, select Print3.
- 5.) In the *Destinations* section, select the service(s) recorded in [step 5](#), Section [7-3-1](#). The destinations list displays the following information:
 - * Name: user defined during service configuration
 - * Type: the type of service
 - * Destination Device: the device for which the service was configured
 - * Dir: direction: output, input, or both (I+O)

NOTE: *Only output services can be associated to the print keys.*

- 6.) In the *Image generated* section, select the parameters related to the service recorded in [step 6](#), Section [7-3-1](#).

Section 7-4 Global Service User Interface (GSUI)

7-4-1 Enter global service user interface

- 1.) When system is running, there is a **start** icon in the system status bar, see [Figure 7-101 on page 7-8](#)

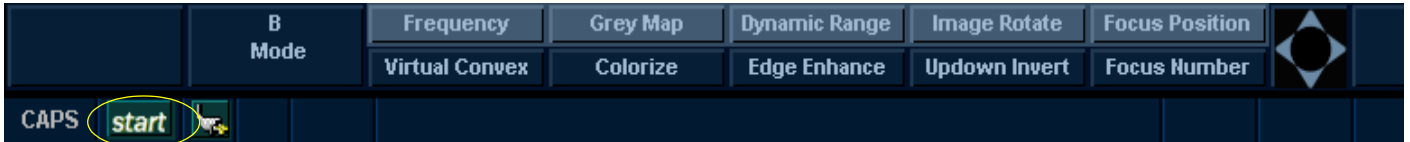

Figure 7-101 system status bar

- 2.) Click **start** Icon, appears the selection menu, choose **Service Platform** icon in the bar, see [Figure 7-102 on page 7-8](#)



Figure 7-102

- Click OK or wait 5 seconds after starting information appears. See [Figure 7-103 on page 7-8](#) .

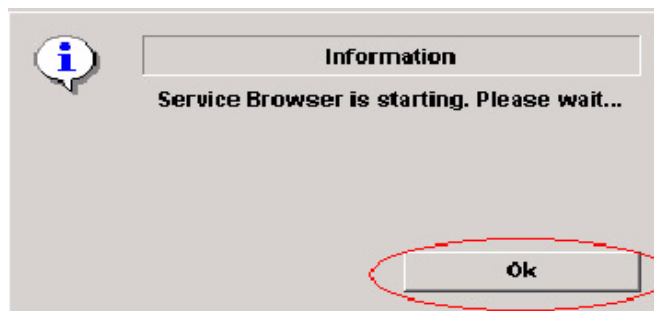

Figure 7-103 Information

7-4-1 Enter global service user interface (cont'd)

- 3.) Select GE Service in option of User Level of GEMS Service Home page and input correct password, press OK button. See [Figure 7-104 on page 7-9](#)

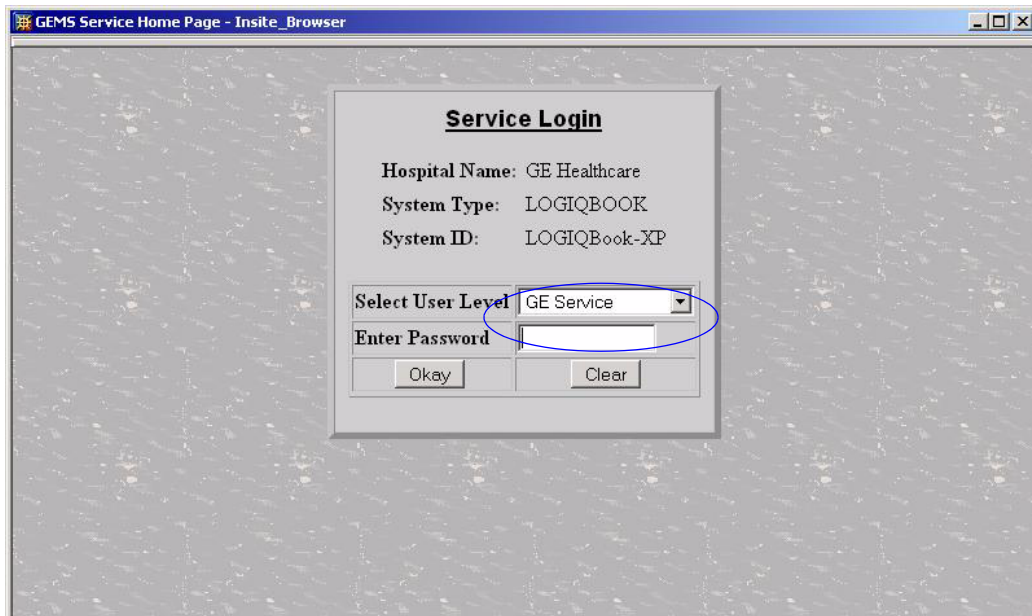

Figure 7-104 Service Login Page

7-4-2 Active Diagnostic Function

- 4.) Choose Diagnostic in Global Service Interface to active diagnostic functions, choose options to activate various functions correspondingly.

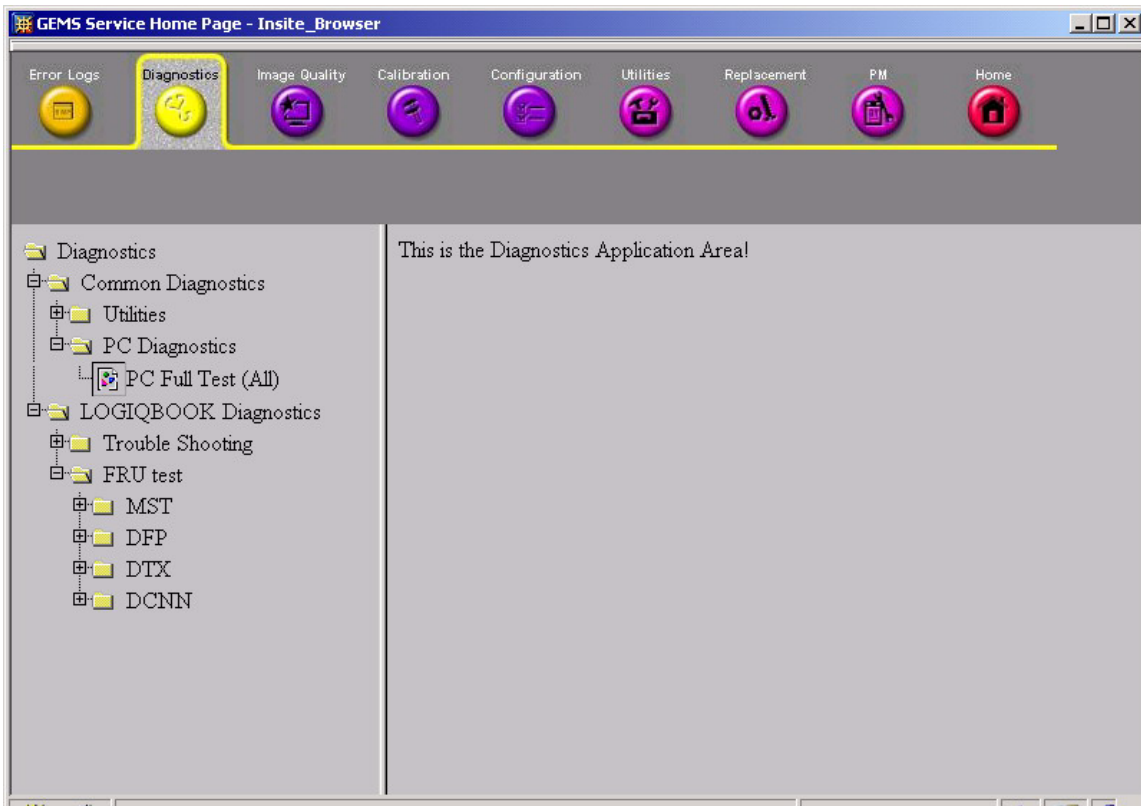

Figure 7-105 Active Diagnostic Function

7-4-3 Reset Database

- 5.) Choose Utilities in Global Service Interface. Click Scanner Utilities.
- 6.) Choose "Reset Database" to start Database reset tool.

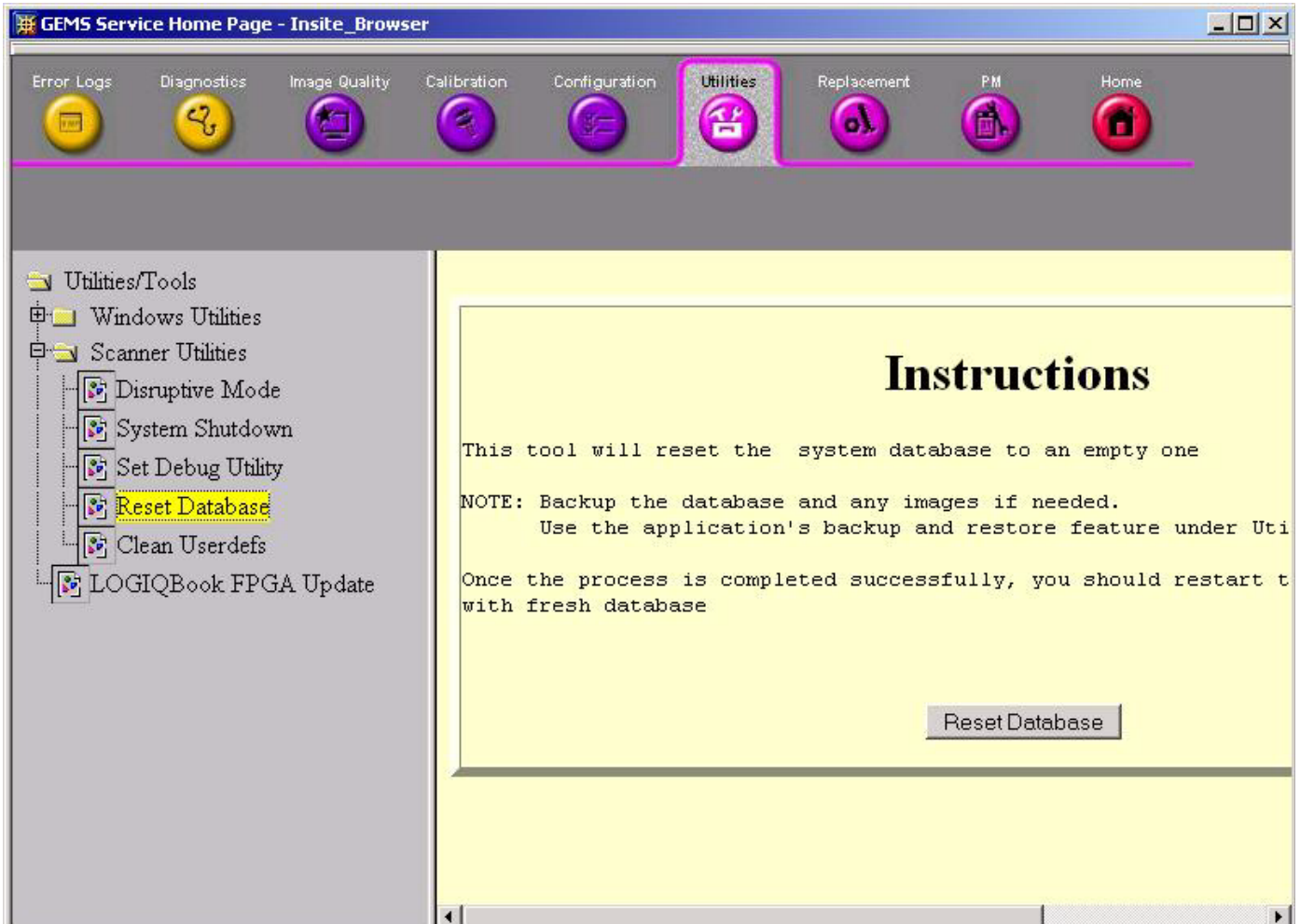

Figure 7-106

- 7.) Click "Reset Database" to Database reset tool.
- 8.) Click "OK" to start reset.

7-4-3 Reset Database (cont'd)

9.) Restart system after completing Database Reset.

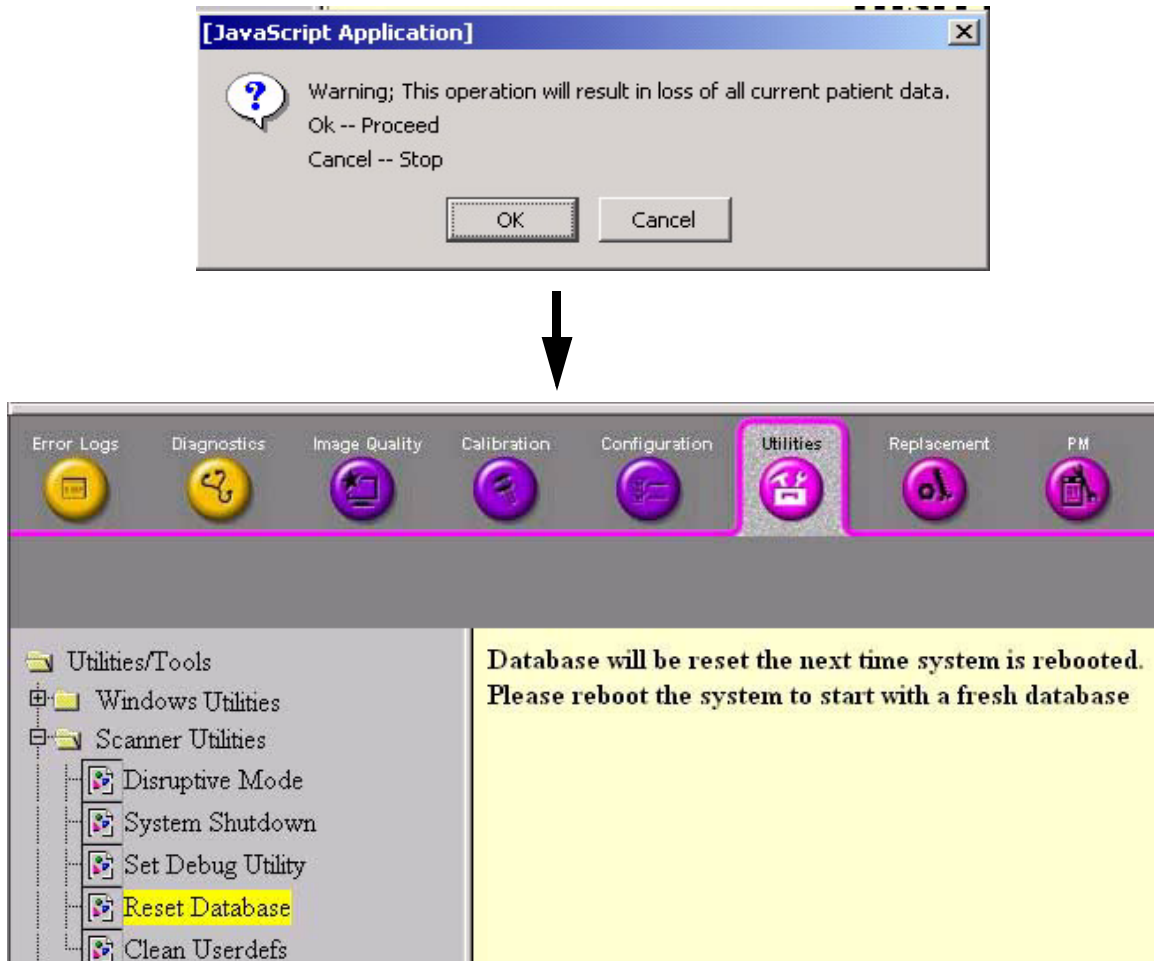

Figure 7-107 Database Reset

7-4-4 Clean Userdefs

- 10.) Choose Utilities in Global Service Interface. Click Scanner Utilities.
- 11.) Choose "Clean Userdefs" to start Userdefs clean tool.

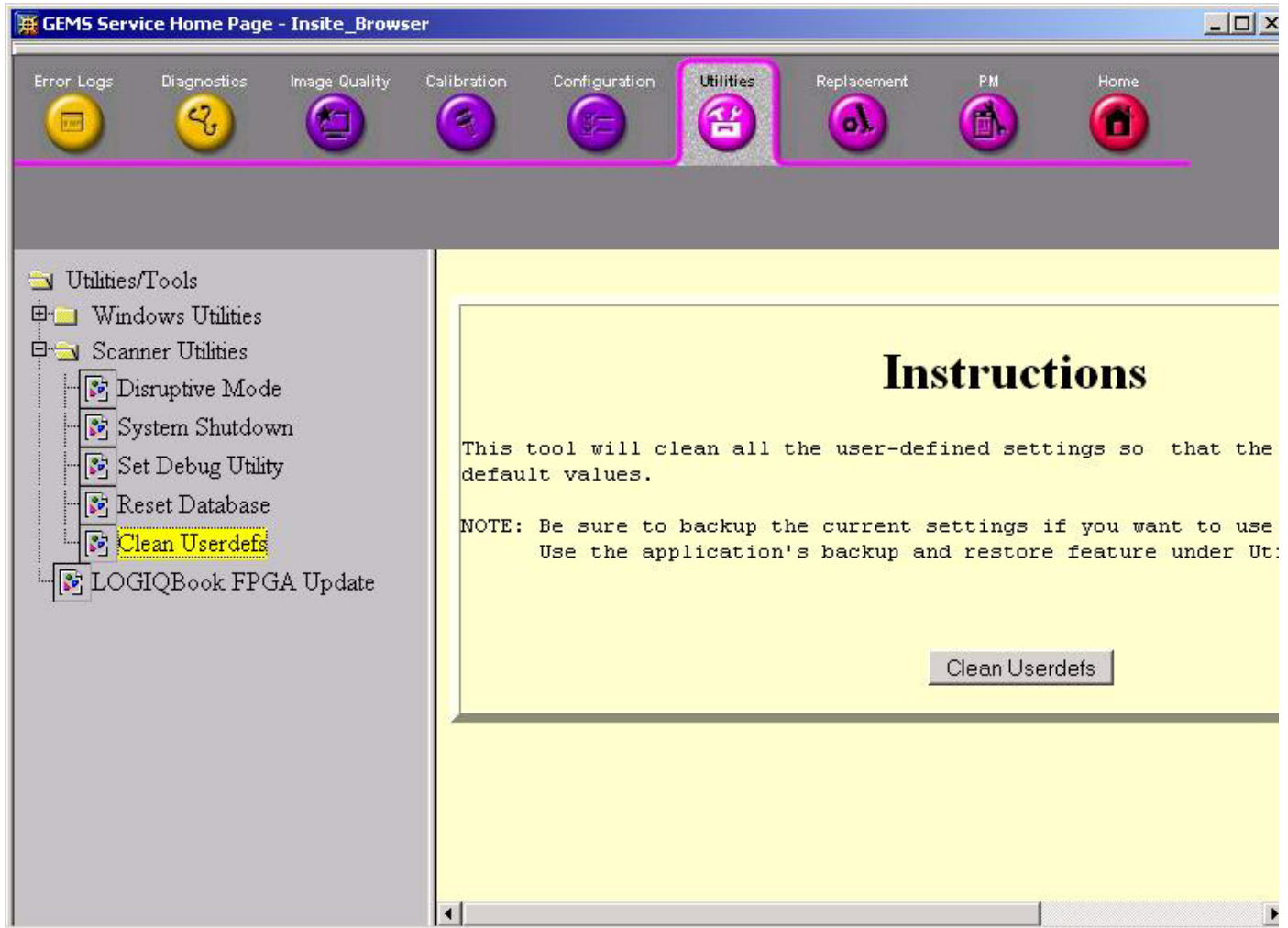

Figure 7-108

- 12.) Click "Clean Userdefs" to Userdefs clean tool.

7-4-4 Clean Userdefs (cont'd)

13.) Click "OK" to start clean.

14.) Restart system after completing Userdefs Clean.

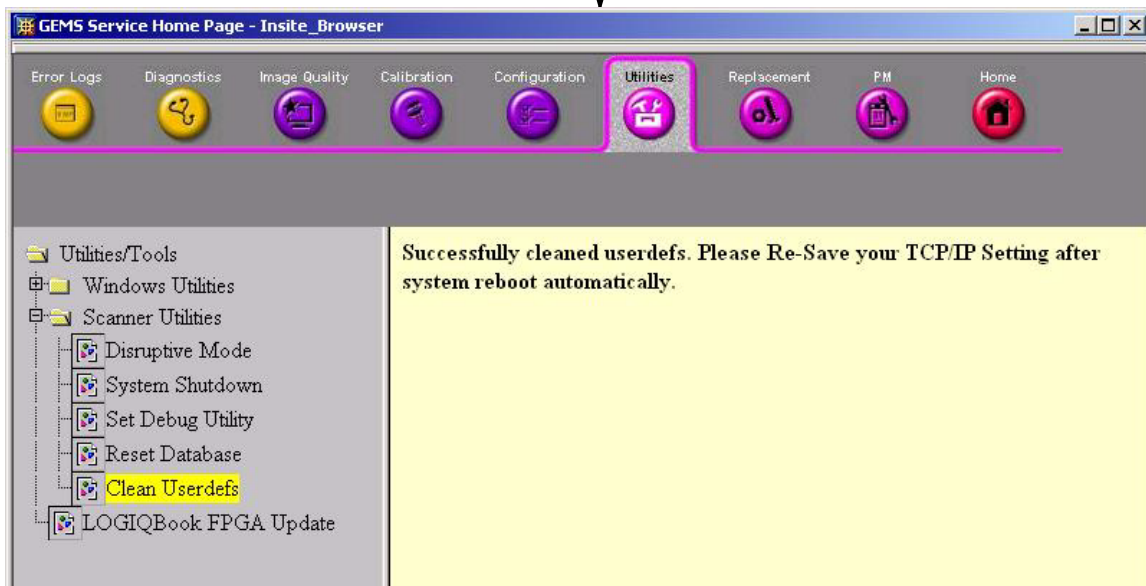
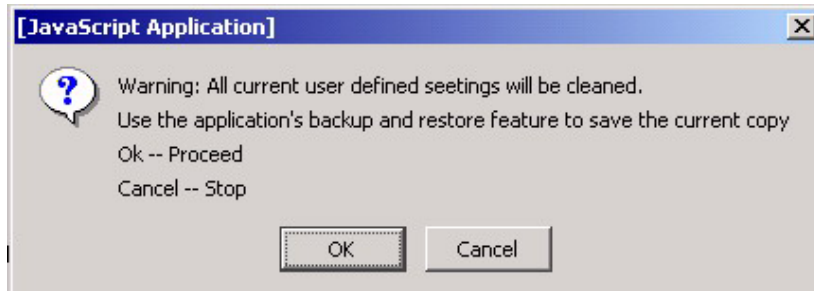

Figure 7-109 Userdefs Clean

7-4-5 Update FPGA

- 15.) Choose Utilities in Global Service Interface.
- 16.) Click “LOGIQ Book XP/XP PRO/XP Vet FPGA Update” to active Fpga update tool.

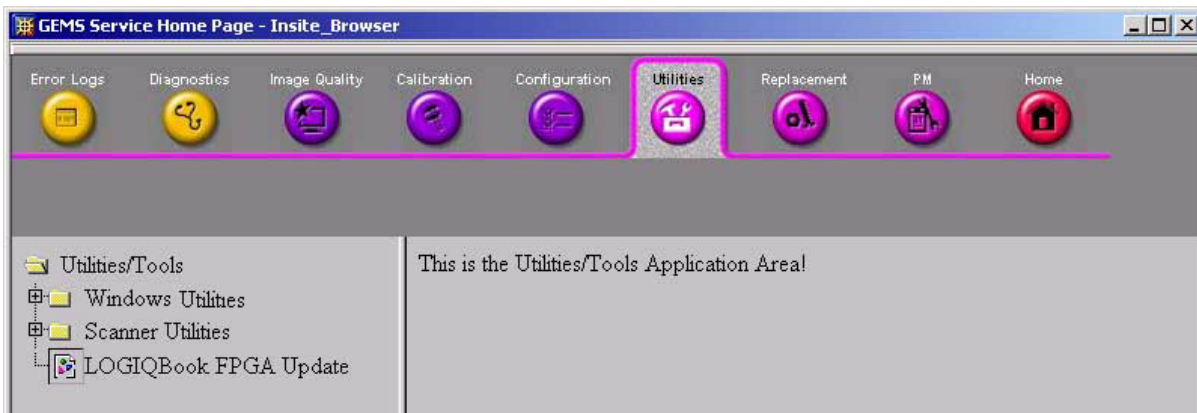

Figure 7-110

- 17.) Click “Update” to Fpga Update tool.
- 18.) Restart system after completing Fpga upgrade.

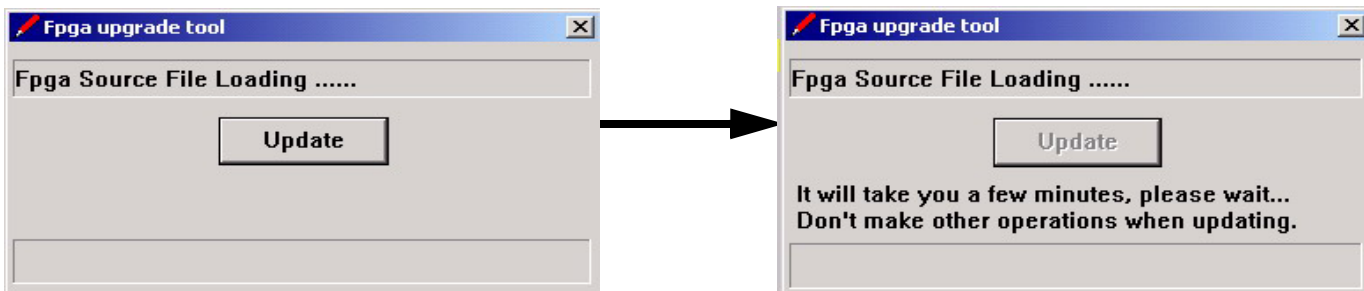

Figure 7-111 Reset Database

7-4-6 Control Frame

Contains the user interface elements used for:

- Diagnostic control, and
- Operator feedback

7-4-6-1 Button

This button has two modes each with appropriate text:

- Execute - to start the diagnostic, and
- Abort - to stop a diagnostic

The button can also be disabled.

7-4-6-2 Loop Count

This is an editable text field that will only accept numeric values with 4 digits or less. When the button is configured as an “execute” button and pressed, the loop count field will be queried to determine the number of times to execute the diagnostic.

7-4-6-3 Progress Indicator

Displays a graphical progress indication to the user.

7-4-6-4 Short Text Message

Displays either a starting message or aborting message, as well as the diagnostic completion status.

7-4-6-5 Background Color

Initially gray, the Control Frame background color changes upon completion of a diagnostic to indicate completion status.

- Fail = Red
- Pass = Green
- Neither pass nor fail = Set back to Gray (for example, final code status is Aborted).

Section 7-5 Common Diagnostics

7-5-1 Utilities

Provides two selections:

7-5-1-1 Disruptive Mode

Allows you to enable or disable disruptive mode troubleshooting.

7-5-1-2 System Shutdown

Allows for system shutdown from the diagnostic menu. Select to *Restart System* or *Shutdown System*. Also, select to retain Disruptive Mode or Not.

After submitting to restart or shutdown a confirmation screen gives one last chance to confirm or cancel the request.

7-5-2 PC Diagnostics (Non-Interactive Tests)**7-5-2-1 CPU Tests****7-5-2-2 Hard Drive Tests****7-5-2-3 Memory Tests****7-5-2-4 CD/DVD Drive Test****7-5-2-5 Video Test****7-5-2-6 USB Test****7-5-3 PC Diagnostics (Interactive Tests)****7-5-3-1 Keyboard Test****7-5-3-2 LCD Test**

Section 7-6 LOGIQ Book XP/XP PRO/XP Vet Diagnostic Descriptions

7-6-1 Troubleshooting

These programs are provided for performing troubleshooting of the system.

Table 7-45 Troubleshooting Menu

Menu	Descriptions	Error Code
Overall Test	Performs all of the troubleshooting tests listed below.	
Image Trouble (Digital) Test	N/A	
Image Trouble (Analog) Test	N/A	

7-6-2 FRU Test

7-6-2-1 MST

These programs are provided for testing the MST board.

Table 7-46 FRU Test, MST Diagnostics Menu

Menu	Descriptions	Error Code
Overall Test	Performs all of the MST board tests listed below.	
Assy Revision Test		10001
TRIG Test	The PC sends the command to the SH4 to generate the trigger for self test. Then the results are returned to the PC.	10002
SH-4 Memory Test	The PC sends the command to the SH4 to check the memory especially for SH-4.	10003
SH-PCI Test 1	The PC sends the command to the SH4 to check the SDRAM in MST.	10004
SH-4 Test	Test the watchdog of SH4.	10005
COMSO BM Test	Use test mode of OQ card to check COMSO.	10006
Transmit HV Test	The HV unit outputs Plus and Minus THV, which is adjustable (variable). This test checks if HVs can be read at A/D and adjusted by SH4.	10007
Supply HV Test	The HV unit generates Plus and Minus SHV for HVSW, which is adjusted to follow THV. Checks if it can be read at A/D in MST.	10008
LV Test	The LV unit outputs four kinds of DC Voltage. This test checks if they can be read at A/D and D/A in MST.	10009
D/A-A/D Test	D/A-A/D channel test.	10010
USC Bus Test	<u>Check USC Bus</u> Checks if the SH4 writes the data properly to USC Register or PMX Register.	10011
PCI/F1 Test (EUSC)	N/A	10012
PCI/F2 Test (IMGD)	N/A	10013
Memory Test	N/A	10014

7-6-2-2 DFP

These programs are provided for testing the DFP board.

Table 7-47 FRU Test, DFP Diagnostics Menu

Menu	Descriptions	Error Code
Overall Test	Performs all of the DFP board tests listed below.	
Assy Revision Test		20001
DUSC I/F Test	Check if the SH4 in the MST can access the DFP board via DUSC bus.	20002
Local Bus Test	Check if SH4 can read and write register of DFP board via DUSC bus.	20003
WRAM Test	The SH4 in MST reads and writes the register of WRAM in DFP via DUSC bus.	20004
OQCARD Test	The SH4 in MST reads and writes the OQCARD registers in DFP via bus.	20005

7-6-2-3 DTX

These programs are provided for testing the DTX board.

Table 7-48 FRU Test, DTX Diagnostics Menu

Menu	Descriptions	Error Code
Overall Test	Performs all of the DTX board tests listed below.	
Assy Revision Test		30001

7-6-2-4 DCNN

These programs are provided for testing the DCNN board.

The PC sends the command to the SH4 in the MST, which brings DCNN into test then gets test report from DCNN via DUSC Bus and sends it back to the PC.

Table 7-49 FRU Test, DCNN Diagnostics Menu

Menu	Descriptions	Error Code
Overall Test	Performs all of the DCNN board tests listed below.	
Assy Revision Test	N/A	40001

7-6-2-5 PC

These programs are provided for testing the PC.

Table 7-50 FRU Test, PC Diagnostics Menu

Menu	Descriptions	Error Code
CPU	CPU test	50001
Hard Drive	Hard Drive test	50002
Memory	Memory test	50003
CDRW	CDRW test	50004
Video	Video test	50005
USB	USB test	50006
PCI Board	PCI Board test	50007
AGP Video Card	AGP Video Card test	50008

Chapter 8

Replacement Procedures

Section 8-1 Overview

8-1-1 Purpose of Chapter 8

This chapter describes replacement procedures for the following modules and subsystems.

Table 8-1 Contents in Chapter 8

Section	Description	Page Number
8-1	Overview	8-1
8-2	Disassembly/Re-assembly	8-1
8-2-1	Warning and Caution	8-1
8-2-2	Handle Assy (FRU No. 312)	8-2
8-3	Trackball Roller Cleaning	8-4

Section 8-2 Disassembly/Re-assembly

8-2-1 Warning and Caution

 **WARNING** *ONLY QUALIFIED SERVICE PERSONNEL SHOULD REMOVE ANY COVERS OR PANELS. ELECTRICAL HAZARDS EXISTS AT SEVERAL POINTS INSIDE. BECOME THOROUGHLY FAMILIAR WITH ALL HAZARDOUS VOLTAGES AND HIGH CURRENT LEVELS TO AVOID ACCIDENTAL CONTACT*

 **CAUTION** Do not wear the ESD wrist strap when you work on live circuits and more than 30V peak is present.

8-2-2 Handle Assy (FRU No. 312)

Purpose: This is a description on how to remove and replace the Handle Assy (FRU No.312).

8-2-2-1 Tools

- Plier

8-2-2-2 Needed Manpower

- 1person, 2 minutes + travel

8-2-2-3 Preparations

- Shut Down the System.

8-2-2-4 Removal Procedure

Refer to [Figure 8-1 on page 8-3](#) .

- 1.) Unscrew the two handle caps on both sides of the system, the rotation direction is counterclockwise.
- 2.) Pull out the Handle.

8-2-2-5 Mounting procedure

- 1.) Install the new parts in the reverse order of removal.

Handle Assy (FRU No. 312) (cont'd)



1)



2)

Figure 8-1 Handle Assy DISASSEMBLY

Section 8-3 Trackball Roller Cleaning

Purpose: This is a description on how to remove the trackball and clean the roller.

8-3-0-1 Tools

- No need.

8-3-0-2 Needed Manpower

- 1persons, 2 minutes + travel

8-3-0-3 Preparations

- Shut Down the System.

8-3-0-4 Procedure

Refer to [Figure 8-2 on page 8-5](#) .

- 1.) Open LCD Assy.
- 2.) Turn other ring counterclockwise.
- 3.) Remove the ring.
- 4.) Using hand, carefully grab and remove the trackball.
- 5.) Carefully clean roller using Qtip.

Trackball Roller Cleaning (cont'd)



2)



3)



4)



5)

Figure 8-2 Trackball Roller Cleaning

This page was intentionally left blank.

Chapter 9

Renewal Parts

Section 9-1 Overview

9-1-1 Purpose of Chapter 9

This chapter gives you an overview of Spare Parts available for the LOGIQ Book XP/XP PRO/XP Vet.

Table 9-2 Contents in Chapter 9

Section	Description	Page Number
9-1	Overview	9-1
9-2	List of Abbreviations	9-1
9-3	Renewal Parts Lists	9-2
9-4	Operator Console Assy	9-3
9-5	Keyboard Assy	9-4
9-6	Bottom Assy	9-4
9-7	Isolation Cart Components	9-5
9-8	Accessories and Kits	9-7
9-9	Manuals	9-10
9-10	Probes	9-11

Section 9-2 List of Abbreviations

- Assy - Assembly
- Ctrl - Control
- FRU 1 - Replacement part available in part hub
- FRU 2 - Replacement part available from the manufacturer (lead time involved)
- KBD - Keyboard
- LCD - Liquid Crystal Display
- BnV - Brightness and Volume
- DFP - Dragon Front Processor Board
- MST - Master Board
- DTX - Dragon Transmit Board
- FPC - Flexible Print Circuit Board

Section 9-3Renewal Parts Lists

9-3-1 Equipment Models Covered in this Chapter

Table 9-3 ACDC Power Pack & ACDC Power Cable list

Part Name	Part Number	Description	Quantity	FRU
ACDC Power Pack unit	5124447	100-240V AC INPUT/20V DC OUTPUT	1	1
ACDC Power Cable	5120411	ACDC Power Cable for USA	1	1
ACDC Power Cable	5120412	ACDC Power Cable for Europe	1	1
ACDC Power Cable	5120439	ACDC Power Cable for China	1	1
ACDC Power Cable	5120440	ACDC Power Cable for Japan	1	1
ACDC Power Cable	5125218	ACDC Power Cable for Australia/New Zealand	1	1
ACDC Power Cable	5125219	ACDC Power Cable for United Kingdom and Ireland	1	1
ACDC Power Cable	5125221	ACDC Power Cable for India/South Africa	1	1
ACDC Power Cable	5125223	ACDC Power Cable for Argentina	1	1
ACDC Power Cable	5125227	ACDC Power Cable for Israel	1	1
ACDC Power Cable	5125228	ACDC Power Cable for Switzerland	1	1

Section 9-4 Operator Console Assy



Figure 9-3 OPERATOR CONSOLE ASSY

Section 9-5 Keyboard Assy

Table 9-4 Keyboard Assy

Item	Part Name	Part Number	Description	Quantity	FRU
201	Trackball	2326353	Trackball	1	1

Section 9-6 Bottom Assy

Table 9-5 Bottom Assy

Item	Part Name	Part Number	Description	Quantity	FRU
312	Handle Kits	5121679	Handle	1	2

Section 9-7 Isolation Cart Components



Figure 9-4 Isolation Cart Components

Table 9-6 Isolation Cart Components

Item	Part Name	Part Number	Description	Quantity	FRU
501	Wheels	5183729	Wheels	1	2
502	Isolation transformer 110V	5180439-2	Isolation transformer 110V	1	2
	Isolation transformer 220V	5180376	Isolation transformer 220V	1	2
503	Handle kits	5183627	Handle kits	1	2
504	Probe holder kits	5183958	Probe holder kits	1	2
505	Hardware kits	5183719	Hardware kits	1	2
506	USA class cable kits	5182671	USA class cable kits	1	2
	European class cable kits	5182937	European class cable kits	1	2
	Chinese class cable kits	5182252	Chinese class cable kits	1	2
	Japanese class cable kits	5182323	Japanese class cable kits	1	2
	Australia/New Zealand class cable kits	5182095	Australia/New Zealand class cable kits	1	2
	United Kingdom and Ireland class cable kits	5182890	United Kingdom and Ireland class cable kits	1	2
	Denmark class cable kits	5182310	Denmark class cable kits	1	2
	India/South Africa class cable kits	5182038	India/South Africa class cable kits	1	2
	Argentina class cable kits	5182881	Argentina class cable kits	1	2
	Israel class cable kits	5182625	Israel class cable kits	1	2
	Switzerland class cable kits	5182631	Switzerland class cable kits	1	2

Table 9-6 Isolation Cart Components

Item	Part Name	Part Number	Description	Quantity	FRU
507	Security lock	5183906	Security lock for Twin	1	2
508	Isolation Cart (110V)	5177673-2	Isolation Cart (110V)	1	2
	Isolation Cart (220V)	5177558-2	Isolation Cart (220V)	1	2

Section 9-8 Accessories and Kits

Table 9-7 Accessories and Kits

Item	Part Name	Part Number	Description	Qty	FRU
601	Battery Pack	2325369-5	Battery	1	2
602	USB CD-RW CN Ver	2327620-2	USB CD-RW with China power cord	1	2
602A	USB CD-RW CN Ver	5138714	USB CD-RW with China power cord	1	2
602B	USB CD-RW CN Ver	5145383	USB CD-RW with China power cord	1	2
602C	USB DVD-RW CN Ver	5251790-4	USB DVD-RW with China power cord	1	2
603	USB CD-RW US Ver	2350123-2	USB CD-RW with America power cord	1	2
603A	USB CD-RW US Ver	5138712	USB CD-RW with America power cord	1	2
603B	USB CD-RW US Ver	5145384	USB CD-RW with America power cord	1	2
603C	USB DVD-RW US Ver	5251789-4	USB DVD-RW with America power cord	1	2
604	USB CD-RW EU Ver	2350124-2	USB CD-RW with Europe power cord	1	2
604A	USB CD-RW EU Ver	5138713	USB CD-RW with Europe power cord	1	2
604B	USB CD-RW EU Ver	5145385	USB CD-RW with Europe power cord	1	2
604C	USB DVD-RW EU Ver	5251788-4	USB DVD-RW with Europe power cord	1	2
604D	LITEON eSAU108 DVDRW	5456273	LITEON eSAU108 DVDRW	1	2
604E	LITEON eUAU108 DVDRW	5456273-2	LITEON eUAU108 DVDRW	1	2
605	USB Footswitch	2327703	Footswitch with USB port	1	2
606	Cisco Wireless LAN Adapter	5124101	Option part (Not available on LOGIQ Book XP PRO)	1	2
607	B&W printer (UP-D897MD) CHN kit	5151262	Option part	1	2
608	B&W printer (UP-D897MD) USA kit	5151259	Option part	1	2
609	B&W printer (UP-D897MD) EUP kit	5151261	Option part	1	2
610	B&W printer (UP-D897MD) JPN kit	5151263	Option part	1	2
611	Color printer (UP-D23MD) CHN Kit	5133106	Option part	1	2
612	Color printer (UP-D23MD) USA Kit	5133107	Option part	1	2
613	Color printer (UP-D23MD) EUP Kit	5133108	Option part	1	2
614	Color printer (UP-D23MD) JPN Kit	5133109	Option part	1	2
615	LBXP series base system load image CD for Service	5129830-2	Option Part	1	2
616	Hardware Kit	5123493	Include all screws and washers	1	2
617	Basic system software load image	5116846-3	LOGIQ Book XP Base system software CD	1	2
617A	Basic system software load image	5116846-4	LOGIQ Book XP Base system software CD(R2.1.4)	1	2

Table 9-7 Accessories and Kits

Item	Part Name	Part Number	Description	Qty	FRU
617B	Basic system software load image	5116846-5	LOGIQ Book XP Base system software CD(R2.1.5)	1	2
618	Application software	5116840	LOGIQ Book XP Application software CD (R2.1.0)	1	2
618A	Application software	5116840-2	LOGIQ Book XP Application software CD (R2.1.2)	1	2
618B	Application software	5116840-3	LOGIQ Book XP Application software CD (R2.1.4)	1	2
618C	Application software	5116840-4	LOGIQ Book XP Application software CD (R2.1.5)	1	2
619	Application software	5136704	LOGIQ Book XP PRO Application software CD (R2.1.1)	1	2
619A	Application software	5136704-2	LOGIQ Book XP PRO Application software CD (R2.1.2)	1	2
619B	Application software	5136704-3	LOGIQ Book XP PRO Application software CD (R2.1.3)	1	2
620	Application software	5136706	LOGIQ Book XP Vet Application software CD (R2.1.1)	1	2
620A	Application software	5136706-2	LOGIQ Book XP Vet Application software CD (R2.1.2)	1	2
621	Network Adapter	2405860	Opinion part (Not available on LOGIQ Book XP PRO)	1	2
622	Isolation box	2364221	Opinion part	1	2
623	Cart Probe Holder	2399123	Cart Rubber Holder	1	2
624	Cart Gel Holder	2399124	Cart Rubber Holder	1	2
625	Cart Cup Holder	2399125	Cart Rubber Holder	1	2
626	Video Adapter-NTSC	2391591	Option Part	1	2
627	Video Adapter-PAL	2391590	Option Part	1	2
628	USB Memory (512M)	5168040	Option Part	1	2
628A	USB Memory 1G	5168040-2	USB Memory 1G	1	2
628B	USB Memory 2G	5168040-3	USB Memory 2G	1	2
628C	USB Memory 4G	5168040-4	USB Memory 4G	1	2
629	USB HUB Assy	5117263	Option Part	1	2
630	VCR Shelf for Cart	2409625	Option Part	1	2
631	USA type Power cord for Printer/VCR	5118339	Option Part	1	2
632	China type Power cord for Printer/VCR	5118340	Option Part	1	2
633	German type Power cord for Printer/VCR	5118341	Option Part	1	2
634	Japan type Power cord for Printer/VCR	5118960	Option Part	1	2
635	3 meter USB cable	5135661	Option Part	1	2

Table 9-7 Accessories and Kits

Item	Part Name	Part Number	Description	Qty	FRU
636	LOGIQ BOOK Carrying Bag	2400680	Option Part	1	2
637	Sterile Monitor Covers Assy	5136142	Option Part	1	2
638	PIT Assy for EU and CN	5146884	PIT Assy for EU and CN	1	2
639	PIT Assy for US	5146885	PIT Assy for US	1	2
640	PIT Assy for JP	5146887	PIT Assy for JP	1	2
641	ECG Module	5129487	Option Part	1	2
642	ECG USB Cable	5146055	Option Part	1	2
643	ECG AHA Cable	5146056	Option Part	1	2
644	ECG IEC Cable	5146739	Option Part	1	2
645	ECG Module with Chinese Lable	5149641	Option Part	1	2
646	HP470 Printer (HP470+PIT) USA Kits	5175689	HP470 Printer (HP470+PIT) without power cord	1	2
647	HP470 Printer (HP470+PIT) EUP Kits	5175988	HP470 Printer (HP470+PIT) without power cord	1	2
648	HP470 Printer (HP470+PIT) CHN Kits	5175546	HP470 Printer (HP470+PIT) without power cord	1	2
649	HP470 Printer (HP470+PIT) JAP Kits	5175350	HP470 Printer (HP470+PIT) without power cord	1	2
650	PC Printer (HP K550) JAP	5175898	PC Printer (HP K550) without power cord	1	2
650A	PC Printer (HP K5400) JAP	5175898-2	PC Printer (HP K5400) without power cord	1	2
651	PC Printer (HP K550) USA	5175122	PC Printer (HP K550) without power cord	1	2
651A	PC Printer (HP K5400) USA	5175122-2	PC Printer (HP K5400) without power cord	1	2
652	PC Printer (HP K550) EUP	5175833	PC Printer (HP K550) without power cord	1	2
652A	PC Printer (HP K5400) EUP	5175833-2	PC Printer (HP K5400) without power cord	1	2
653	PC Printer (HP K550) CHN	5175554	PC Printer (HP K550) without power cord	1	2
653A	PC Printer (HP K5400) CHN	5175554-2	PC Printer (HP K5400) without power cord	1	2
654	Network Adapter Netgear FA511	5328637	Network Adapter Netgear FA511	1	2
655	Peripheral Driver Patch CD Installation Kit	5455722	Peripheral Driver Patch CD Installation Kit	1	2
655A	Peripheral Driver Patch USB Installation Kit	5453562	Peripheral Driver Patch USB Installation Kit	1	2
655B	Peripheral Driver Patch USB Installation Kit	5453562-2	Peripheral Driver Patch USB Installation Kit	1	2
656	LOGIQ BOOK Series Probe Connect Lock Service Kit	5391601	LOGIQ BOOK Series Probe Connect Lock Service Kit	1	2
657	Aquasonic 100 Ultrasound Transmission Gel 0.25L	5130518	Aquasonic 100 Ultrasound Transmission Gel 0.25L	1	2

Section 9-9Manuals

Table 9-8 MANUALS

Item	Part Name	Part Number	Description	Quantity	FRU
	LOGIQ Book XP/XP PRO/XP Vet Service Manual	2406070-100	Service Manual	1	N
System User Manuals					
	User Manual, LOGIQ Book XP/XP PRO, English	2402722-100	Basic User Manual	1	N
	User Manual, LOGIQ Book XP/XP PRO, French	2402722-101	Basic User Manual	1	N
	User Manual, LOGIQ Book XP/XP PRO, Spanish	2402722-106	Basic User Manual	1	N
	User Manual, LOGIQ Book XP/XP PRO, German	2402722-108	Basic User Manual	1	N
	User Manual, LOGIQ Book XP/XP PRO, Italian	2402722-111	Basic User Manual	1	N
	User Manual, LOGIQ Book XP/XP PRO, Portuguese	2402722-127	Basic User Manual	1	N
	User Manual, LOGIQ Book XP/XP PRO, Japanese	2402722-140	Basic User Manual	1	N
	User Manual, LOGIQ Book XP/XP PRO, Chinese	2402722-141	Basic User Manual	1	N
	User Manual, LOGIQ Book XP Vet, English	5135382-100	Basic User Manual	1	N
	User Manual, LOGIQ Book XP Vet, French	5135382-101	Basic User Manual	1	N
	User Manual, LOGIQ Book XP Vet, Spanish	5135382-106	Basic User Manual	1	N
	User Manual, LOGIQ Book XP Vet, German	5135382-108	Basic User Manual	1	N
	User Manual, LOGIQ Book XP Vet, Italian	5135382-111	Basic User Manual	1	N
	User Manual, LOGIQ Book XP Vet, Portuguese	5135382-127	Basic User Manual	1	N
	User Manual, LOGIQ Book XP Vet, Japanese	5135382-140	Basic User Manual	1	N
	User Manual, LOGIQ Book XP Vet, Chinese	5135382-141	Basic User Manual	1	N
System Quick Start Guide					
	Quick Start Guide, LOGIQ Book XP/XP PRO/XP Vet, English	2410842-100	Quick Start Guide	1	N
	Quick Start Guide, LOGIQ Book XP/XP PRO/XP Vet, French	2410842-101	Quick Start Guide	1	N
	Quick Start Guide, LOGIQ Book XP/XP PRO/XP Vet, Spanish	2410842-106	Quick Start Guide	1	N
	Quick Start Guide, LOGIQ Book XP/XP PRO/XP Vet, German	2410842-108	Quick Start Guide	1	N
	Quick Start Guide, LOGIQ Book XP/XP PRO/XP Vet, Italian	2410842-111	Quick Start Guide	1	N
	Quick Start Guide, LOGIQ Book XP/XP PRO/XP Vet, Portuguese	2410842-127	Quick Start Guide	1	N
	Quick Start Guide, LOGIQ Book XP/XP PRO/XP Vet, Japanese	2410842-140	Quick Start Guide	1	N
	Quick Start Guide, LOGIQ Book XP/XP PRO/XP Vet, Chinese	2410842-141	Quick Start Guide	1	N

Section 9-10 Probes

Table 9-9 Probes on LOGIQ Book XP/XP PRO

Item	Part Name	Part Number	Description	Quantity	FRU
701	3C-RS	2290776	Probe (Center Frequency: 3.8MHz)	1	1
702	E8C-RS	2290777	Probe (Center Frequency: 6.5MHz)	1	1
703	8C -RS	2354971	Probe (Center Frequency: 6.5MHz)	1	1
704	i12L-RS	2377942	Probe (Center Frequency: 5.6MHz)	1	1
705	8L-RS	2376127	Probe (Center Frequency: 6.2MHz)	1	1
706	3S-RS**	2323337	Probe (Center Frequency: 2.0MHz)	1	1
707	i739-RS*	2404995	Probe (Center Frequency: 6.5MHz)	1	1
708	T739-RS	2404999	Probe (Center Frequency: 6.5MHz)	1	1



NOTICE * i739-RS are not available on LOGIQ Book XP PRO.



NOTICE ** Availability of 3S-RS depends on the configuration of the LOGIQ Book XP PRO.

Table 9-10 Probes on LOGIQ Book XP Vet

Item	Part Name	Part Number	Description	Quantity	FRU
701	3C-RS	5134641	Probe (Center Frequency: 3.8MHz)	1	1
702	E8C-RS	5134643	Probe (Center Frequency: 6.5MHz)	1	1
703	8C -RS	5134642	Probe (Center Frequency: 6.5MHz)	1	1
704	i12L-RS	5134645	Probe (Center Frequency: 5.6MHz)	1	1
705	8L-RS	5134644	Probe (Center Frequency: 6.2MHz)	1	1
706	3S-RS	5134647	Probe (Center Frequency: 2.0MHz)	1	1
707	i739-RS LC	5136420	Probe (Center Frequency: 6.5MHz)	1	1
708	T739-RS	5134646	Probe (Center Frequency: 6.5MHz)	1	1

This page was intentionally left blank.

Chapter 10

Care & Maintenance

Section 10-1 Overview

10-1-1 Periodic Maintenance Inspections

It has been determined by engineering that your LOGIQ Book XP/XP PRO/XP Vet system does not have any high wear components that fail with use, therefore no Periodic Maintenance Inspections are mandatory. Some Customers Quality Assurance Programs may require additional tasks and or inspections at a different frequency than listed in this manual.

10-1-2 Purpose of Chapter 10

This chapter describes **Care & Maintenance** on the scanner and peripherals. These procedures are intended to **maintain the quality** of the ultrasound **systems performance**. Read this chapter completely and familiarize yourself with the procedures before performing a task.

Table 10-1 Contents in Chapter 10

Section	Description	Page Number
10-1	Overview	10-1
10-2	Why do Maintenance	10-2
10-3	Maintenance Task Schedule	10-2
10-4	Tools Required	10-4
10-5	System Maintenance	10-5
10-6	Electrical Safety Tests	10-11
10-7	When There's Too Much Leakage Current...	10-18

 **CAUTION** Practice good ESD prevention. Wear an anti-static strap when handling electronic parts and even when disconnecting/connecting cables.

 **DANGER** **BE SURE TO DISCONNECT THE SYSTEM POWER PLUG AND REMOVE THE BATTERY BEFORE YOU REMOVE ANY PARTS. BE CAUTIOUS WHENEVER POWER IS STILL ON AND COVERS ARE REMOVED.**

 **CAUTION** Do not pull out or insert circuit boards while power is ON.

 **CAUTION** Do not operate this unit unless all board covers and frame panels are securely in place. System performance and cooling require this.

Section 10-2 Why do Maintenance

10-2-1 Keeping Records

It is good business practice that ultrasound facilities maintain records of periodic and corrective maintenance. The Ultrasound Periodic Maintenance Inspection Certificate provides the customer with documentation that the ultrasound scanner is maintained on a periodic basis.

A copy of the Ultrasound Periodic Maintenance Inspection Certificate should be kept in the same room or near the scanner.

10-2-2 Quality Assurance

In order to gain accreditation from organizations such as the American College of Radiology (USA), it is the customer's responsibility to have a quality assurance program in place for each scanner. The program must be directed by a medical physicist, the supervising radiologist/physician or appropriate designee.

Routine quality control testing must occur regularly. The same tests are performed during each period so that changes can be monitored over time and effective corrective action can be taken.

Testing results, corrective action and the effects of corrective action must be documented and maintained on the site.

Your GE service representative can help you with establishing, performing and maintaining records for a quality assurance program. Please contact us for coverage information and/or price for service.

Section 10-3 Maintenance Task Schedule

10-3-1 How often should care & maintenance tasks be performed?

The Care & Maintenance Task Schedule (provided on page 10-3) specifies how often your LOGIQ Book XP/XP PRO/XP Vet should be serviced and outlines items requiring special attention.

NOTE: *It is the customer's responsibility to ensure the LOGIQ Book XP/XP PRO/XP Vet care & maintenance is performed as scheduled in order to retain its high level of safety, dependability and performance.*

Your GE Service Representative has an in-depth knowledge of your LOGIQ Book XP/XP PRO/XP Vet ultrasound scanning system and can best provide competent, efficient service. Please contact us for coverage information and/or price for service.

The service procedures and recommended intervals shown in the Care & Maintenance Task Schedule assumes that you use your LOGIQ Book XP/XP PRO/XP Vet for an average patient load (10-12 per day) and use it as a primary mobile unit which is transported between diagnostic facilities.

NOTE: *If conditions exist which exceed typical usage and patient load, then it is recommended to increase the maintenance frequencies.*

Table 10-2 Customer Care Schedule

Service at Indicated Time	Daily	Weekly	Monthly	Per Facilities QA Program	Notes
Clean Probes	●*				* or before each use
Clean ECG	●*				* or before each use
Inspect AC Mains Cable			●		Mobile Unit Check Weekly
Inspect Cables and Connectors			●		
Clean Console			●		
Clean LCD			●		
Console Leakage Current Checks				See Note	Annually
Peripheral Leakage Current Checks				See Note	Annually
Surface Probe Leakage Current Checks				See Note	Annually
Endocavity Probe Leakage Current Checks				See Note	Quarterly Annually
Measurement Accuracy Checks				See Note	Annually
Probe/Phantom Checks				See Note	Quarterly Annually

NOTE: May require specialized equipment to complete.

NOTE: PMs are not mandatory, the table above is for reference only.

Section 10-4 Tools Required

10-4-1 Special Tools, Supplies and Equipment

10-4-1-1 Specific Requirements for Care & Maintenance

Table 10-3 Overview of Requirements for Care & Maintenance

Tool	Part Number	Comments
Digital Volt Meter (DVM)		
Anti Static Kit	46-194427P231 46-194427P279 46-194427P369 46-194427P373 46-194427P370	Kit includes anti-static mat, wrist strap and cables for 200 to 240 V system 3M #2204 Large adjustable wrist strap 3M #2214 Small adjustable wrist strap 3M #3051 conductive ground cord
Anti Static Vacuum Cleaner	46-194427P278 46-194427P279	120V 230V
QIQ Phantom	E8370RB	RMI Grayscale Target Model 403GS
B/W Printer Cleaning Sheet		See printer user manual for requirements
Color Printer Cleaning Sheet		See printer user manual for requirements
Disposable Gloves		

Section 10-5 System Maintenance

10-5-1 Preliminary Checks

The preliminary checks take about 15 minutes to perform. Refer to the system user documentation whenever necessary.

Table 10-4 System Checks

Step	Item	Description
1	Ask & Listen	Ask the customer if they have any problems or questions about the equipment.
2	Paperwork	Fill in the top of the Ultrasound Inspection Certificate (see page 10- 19). Note all probes and system options.
3	Power up	With AC input. Turn the system power on and verify that all fans and peripherals turn on. Watch the displays during power up to verify that no warning or error messages are displayed. Check the Battery recharging. Without AC input, use internal battery.
4	Probes	Verify that the system properly recognizes all probes.
5	Displays	Verify proper display on the LCD.
6	Presets	Backup all customer presets on an CD-RW.

10-5-2 Functional Checks (See Also Chapter 4)

The functional checks take about 60 minutes to perform. Refer to the system user documentation whenever necessary.

10-5-2-1 System Checks

Table 10-5 System Functional Checks

÷	Step	Description
	B-Mode	Verify basic B-Mode (2D) operation. Check the basic system controls that affect this mode of operation.
	CF-Mode*	Verify basic CF-Mode (Color Flow Mode) operation. Check the basic system controls that affect this mode of operation.
	Doppler Modes*	Verify basic Doppler operation (PW if available). Check the basic system controls that affect this mode of operation.
	M-Mode	Verify basic M-Mode operation. Check the basic system controls that affect this mode of operation.
	Applicable Software Options	Verify the basic operation of all optional modes such as Multi-Image, 3D, Harmonics, Cine,... etc. Check the basic system controls that affect each options operation.
	Xmit/Recv Elements	Use the Visual Channel Utility on the loop connect to verify that all system xmit/recv channels are functional.
	Keyboard Test	Perform the Keyboard Test Procedure to verify that all keyboard controls are OK.
	LCD	Verify basic LCD display functions. Refer to Chapter 3 of the User Manual.
	Software Menu check	Verify Software Menu display functions. Refer to Chapter 3 of the User Manual.
	Measurements	Scan a gray scale phantom and use the measurement controls to verify distance and area calculation accuracy. Refer to the User Manual, Chapter 18, for measurement accuracy specifications.

NOTE: * Some software may be considered standard depending upon system model configuration.



NOTICE * 3D is not available on Pro American Version.



NOTICE * CF and Doppler mode are options on Vet and Pro American Version.

10-5-2-2 Peripheral/Option Checks

If any peripherals or options are not part of the system configuration, the check can be omitted. Refer to the User Manual for a list of approved peripherals/options.

Table 10-6 GE Approved Peripheral/Hardware Option Functional Checks

Step	Item	Description
1	B/W Printer	Verify hardcopy output of the B/W video page printer. Clean heads and covers if necessary.
2	Color Printer	Verify hardcopy output of the Color video page printer. Clean heads and covers if necessary.
3	DICOM*	Verify that DICOM is functioning properly. Send an image to a DICOM device.
4	Footswitch	Verify that the footswitch is functioning as programmed. Clean as necessary.
5	CD-RW	Verify that the CD-RW is functioning properly. Clean heads and covers if necessary.



NOTICE * This function is not available on Pro American Version.

10-5-3 Input Power

10-5-3-1 AC/DC Adapter Inspection

Table 10-7 AC/DC Adapter Inspection

Step	Item	Description
1	Unplug Cord	Disconnect the mains cable from the wall and system.
2	Inspect	Inspect it and its connectors for damage of any kinds.
3	Verify	Verify that the LINE wires are properly attached to the terminals, and that no strands may cause a short circuit.

10-5-4 Cleaning

10-5-4-1 General Cleaning

Table 10-8 General Cleaning

Step	Item	Description
1	Console	Remove the battery. Use a fluid detergent in warm water on a soft, damp cloth to carefully wipe the entire system. Be careful not to get the cloth too wet so that moisture does not enter the console.
2	Probe Holder	Clean probe holders. (they may need to be soaked to remove excess gel).
3	LCD	Use a soft, non-abrasive folder cloth. Gently wipe the LCD face. DO NOT use a glass cleaner that has a hydrocarbon base (such as Benzene, Methy Alcohol or Methy Ethyl Ketone) on LCD with the filter (anti-glare shield).

10-5-5 Physical Inspection

Table 10-9 Physical Checks

Step	Item	Description
1	Labeling	Verify that all system labeling is present and in readable condition. Refer to User Manual, for details.
2	Scratches & Dents	Inspect the console for dents, scratches or cracks.
3	Control Panel	Inspect keyboard and control panel. Note any damaged or missing items.
4	Cables & Connectors	Check all internal cable harnesses and connectors for wear and secure connector seating. Pay special attention to footswitch assembly and probe strain or bend reliefs.
5	Shielding & Covers	Check to ensure that all EMI shielding, internal covers, air flow panels and screws are in place. Missing covers and hardware could cause EMI/RFI problems while scanning.
6	External I/O	Check all connectors for damage.
7	Op Panel Lights	Check for proper operation of all operator panel and Freeze Key light.

10-5-6 Optional Diagnostic Checks

Optionally you can access the diagnostic software as described in Chapters 5 or 7. View the error logs and run desired diagnostics.

10-5-6-1 View the Logs

- 1.) Review the system error log for any problems.
- 2.) Check the temperature log to see if there are any trends that could cause problems in the future.
- 3.) Check the Configuration Log; update if needed.

10-5-7 Probe Maintenance

10-5-7-1 Probe Related Checks

Table 10-10 Probe Related Checks

Step	Item	Description
1	Probe Holder	Clean probe holders (they may need to be soaked to remove excess gel).
2	Probes	Thoroughly check the system probe connectors and remove dust from inside the connector sockets if necessary. Visually check for bent, damaged or missing pins

10-5-7-2 Basic Probe Care

The system user manuals and various probe handling cards provide a complete description of probe care, maintenance, cleaning and disinfection. Ensure that you are completely familiar with the proper care of GE probes.

Ultrasound probes can be easily damaged by improper handling. See the User Manual and probe care cards for more details. Failure to follow these precautions can result in serious injury and equipment damage. Failure to properly handle or maintain a probe may also void its warranty.

Any evidence of wear indicates the probe cannot be used.

Do a visual check of the probe pins and system sockets before plugging in a probe.

10-5-7-3 Basic Probe Cleaning

Refer to the User's Manual for details on probe cleaning.

NOTE: *To help protect yourself from blood borne diseases, wear approved disposable gloves. These are made of nitrile derived from vegetable starch to prevent allergic latex reactions.*

NOTE: *Failure to follow the prescribed cleaning or disinfection procedures will void the probe's warranty. DO NOT soak or wipe the lens with any product not listed in the User Manual. Doing so could result in irreparable damage to the probe. Follow care instructions that came with the probe.*

NOTE: *Disinfect a defective probe before you return it. Be sure to tag the probe as being disinfected.*

10-5-8 Battery Performance Maintenance

It is recommended to do battery performance maintenance one time per year.

Please follow the flow chart below to carry out battery performance maintenance.

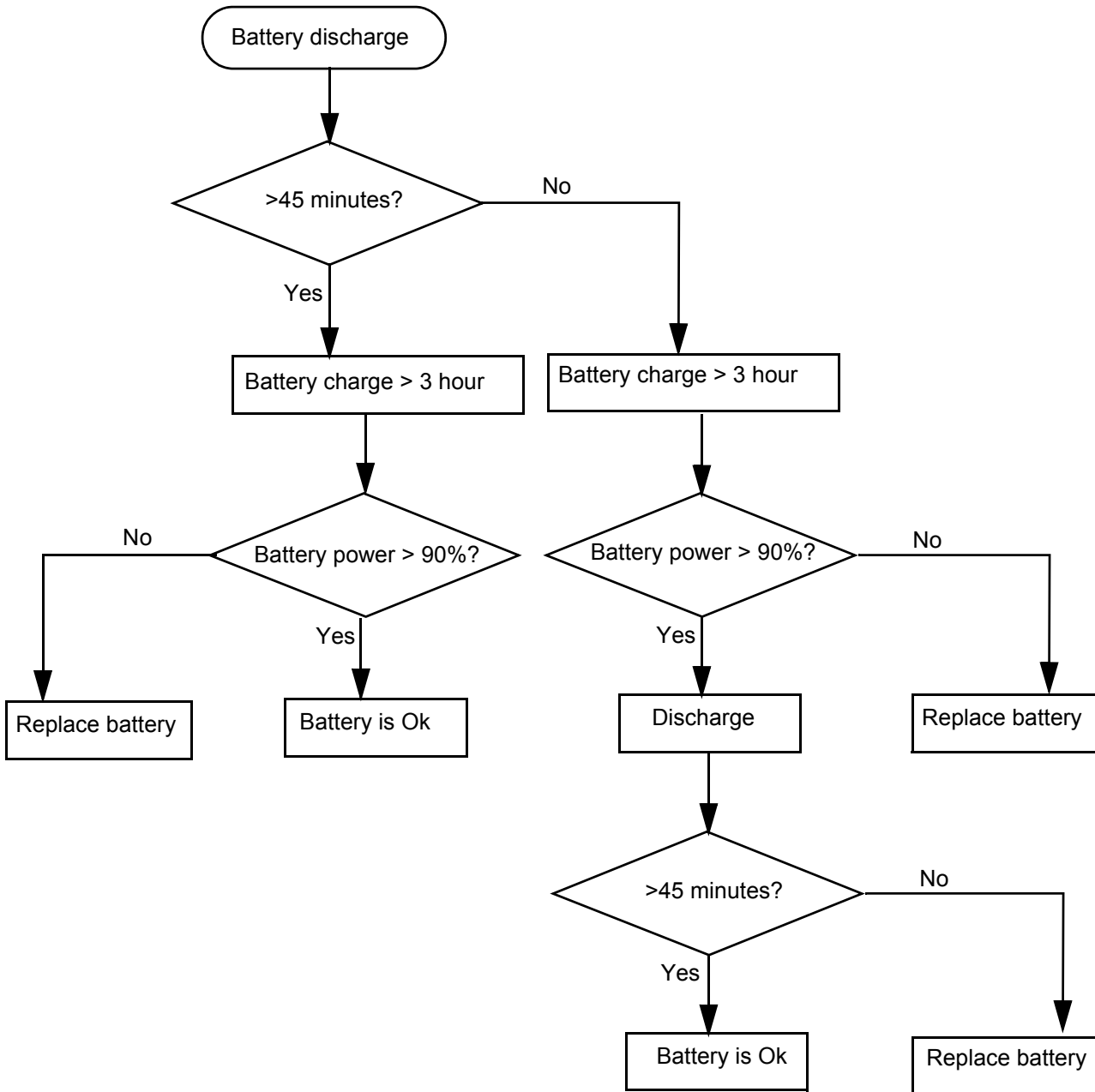

Figure 10-1 Flow chart of Battery Performance Maintenance

NOTE: Disconnect all probes when discharge battery.

NOTE: Discharge the battery to let the system automatically shut down.

Section 10-6 Electrical Safety Tests

10-6-1 Safety Test Overview

The electrical safety tests in this section are based on and conform to IEC 60601-1 Medical Equipment Safety Standards. They are intended for the electrical safety evaluation of cord-connected, electrically operated, patient care equipment. If additional information is needed, refer to the IEC 60601-1 documents.

 **WARNING** ***THE USER MUST ENSURE THAT THE SAFETY INSPECTIONS ARE PERFORMED AT LEAST EVERY 6 MONTHS ACCORDING TO THE REQUIREMENTS OF THE PATIENT SAFETY STANDARD IEC-EN 60601-1. ONLY TRAINED PERSONS ARE ALLOWED TO PERFORM THE SAFETY INSPECTIONS MENTIONED ABOVE.***

 **CAUTION** To avoid electrical shock, the unit under test must not be connected to other electrical equipment. The unit under test must not be contacted by users or patients while performing these tests.

 **CAUTION** Possible risk of infection. Do not handle soiled or contaminated probes and other components that have been in patient contact. Follow appropriate cleaning and disinfecting procedures before handling the equipment.

Test the system, peripherals and probes for leakage current. Excessive leakage current can cause injury or death in sensitive patients. High leakage current can also indicate degradation of insulation and a potential for electrical failure. Do not use probes or equipment having excessive leakage current.

To minimize the risk that a probe may shock someone the customer should:

- Not use a probe that is cracked or damaged in any way
- Check probe leakage current:
 - * Based on your facilities QA program for surface probes
 - * Based on your facilities QA program for endocavitary probes
 - * whenever probe damage is suspected

10-6-2 GEMS Leakage Current Limits

The following limits are summarized for IEC 60601-1 Medical Equipment Safety Standards. These limits are GEMS standards and in some cases are lower than the above standards listed.

Table 10-11 Chassis Leakage Current Limits—Accessible Metal Surfaces

Country	Normal Condition	Open Ground	Reverse Polarity	Open Neutral
All (Except USA & Canada)	0.1 mA	0.5 mA	0.5 mA	0.5 mA
USA & Canada	0.1 mA	0.3 mA	0.3 mA	0.3 mA

Table 10-12 Type BF Applied Part Leakage Current Limits - Probes surface

Country	Normal Condition	Open Ground	Reverse Polarity	Open Neutral	*Mains Applied
All	0.1 mA	0.5 mA	0.5 mA	0.5 mA	5.0 mA

Table 10-13 Type CF Applied Part Leakage Current Limits - ECG Connections

Country	Normal Condition	Open Ground	Reverse Polarity	Open Neutral	*Mains Applied
All	0.01 mA	0.05 mA	0.05 mA	0.05 mA	0.05 mA

NOTE: **Mains Applied refers to the sink leakage test where mains (supply) voltage is applied to the part to determine the amount of current that will pass (or sink) to ground if a patient contacted mains voltage.*

The following tests are performed at the factory and should be performed at the site. These tests are: chassis leakage current, and probe leakage current. All measurements are made with an electrical safety analyzer.

10-6-3 Outlet Test - Wiring Arrangement

Test all outlets in the area for proper grounding and wiring arrangement by plugging in the neon outlet tester and noting the combination of lights that are illuminated. Any problems found should be reported to the hospital immediately and the receptacle should not be used.

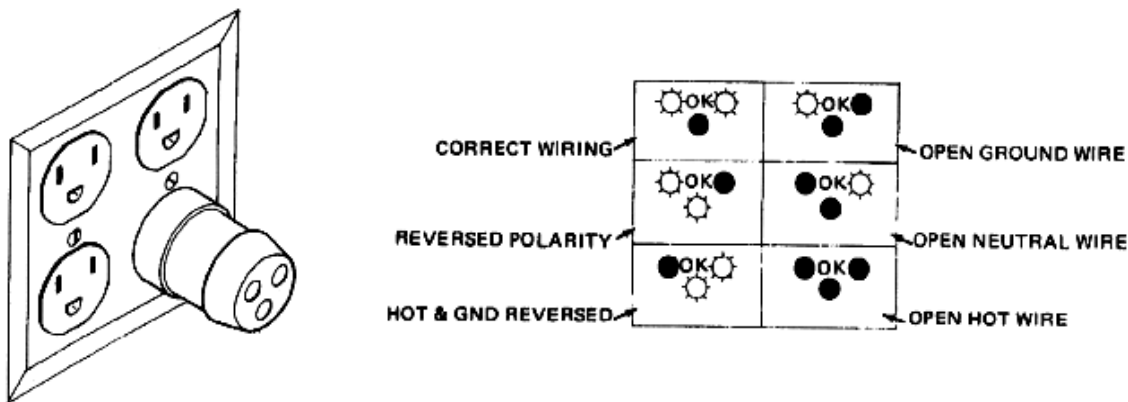

Figure 10-2 Typical Alternate Outlet Tester

NOTE: No outlet tester can detect the condition where the Neutral (grounded supply) conductor and the Grounding (protective earth) conductor are reversed. If later tests indicate high leakage currents, this should be suspected as a possible cause and the outlet wiring should be visually inspected.

10-6-4 Chassis Leakage Current Test

10-6-4-1 Definition

This test measures the current that would flow in a grounded person who touched accessible metal parts of the bedside station if the ground wire should break. The test verifies the isolation of the power line from the chassis. The meter is connected from accessible metal parts of the case to ground. Measurements should be made with the unit On and Off, with the power line polarity Normal and Reversed. Record the highest reading.

 **CAUTION Electric Shock Hazard. When the meter's ground switch is OPEN, don't touch the unit!**

 **CAUTION Equipment damage possibility. Never switch the Polarity and the status of Neutral when the unit is powered ON. Be sure to turn the unit power OFF before switching them using the POLARITY switch and/or the NEUTRAL switch. Otherwise, the unit may be damaged.**

10-6-4-2 Generic Procedure

The test verifies the isolation of the power line from the chassis. The testing meter is connected from accessible metal parts of the case to ground. Measurements should be made with the unit ON and OFF, with the power line polarity Normal and Reversed. Record the highest reading of current.

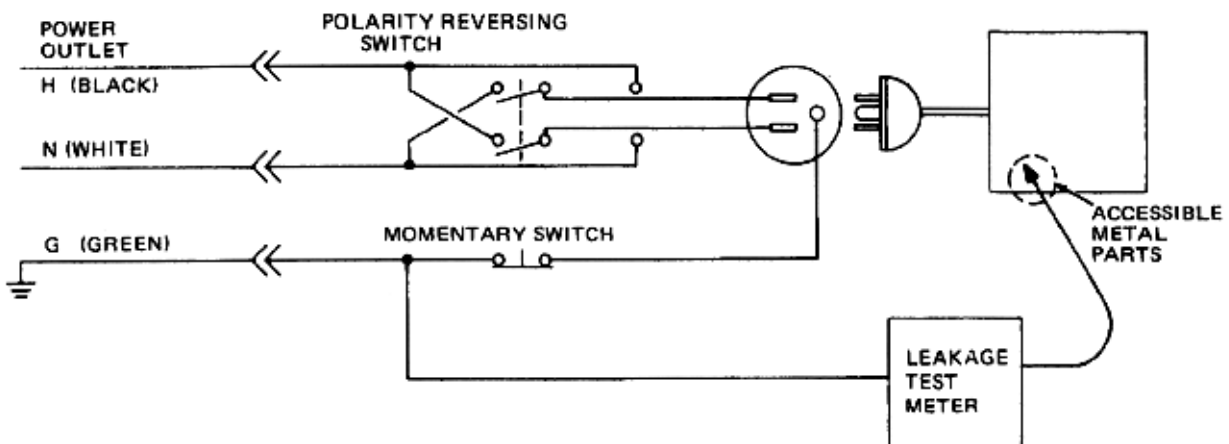

Figure 10-3 Set Up for Chassis Source Leakage Current, IEC 601-1 Clause 19 - Continuous Leakage Currents and Patient, Auxiliary Currents

When using the Microguard or a similar test instrument, its power plug may be inserted into the wall outlet and the equipment under test is plugged into the receptacle on the panel of the meter. This places the meter in the grounding conductor and the current flowing from the case to ground will be indicated in any of the current ranges. The maximum allowable limit for chassis source leakage is shown in [Table 10-11](#).

10-6-4-3 Data Sheet for enclosure Source Leakage Current

The test passes when all readings measure less than the value shown in [Table 10-11](#). Record all data on the PM Inspection Certificate.

Table 10-14 Typical Data Sheet for enclosure Source Leakage Current

Unit Power	Tester Polarity Switch	Tester Neutral or Ground Switch	Test 1 Speaker Cover	Test 2 Real Panel Metal Parts	Optional Test 3	Optional Test 4
Enter Name of tested peripheral here:						
ON	NORM	OPEN				
ON	NORM	CLOSED				
ON	REV	OPEN				
ON	REV	CLOSED				
OFF	NORM	OPEN				
OFF	NORM	CLOSED				
OFF	REV	OPEN				
OFF	REV	CLOSED				

10-6-5 Probe Leakage Current Test

10-6-5-1 Definition

This test measures the current that would flow to ground from any of the probes through a patient who is being scanned and becomes grounded by touching some other grounded surface.

10-6-5-2 Generic Procedure

Measurements should be made with the ground open and closed, with power line polarity normal and reversed, and with the unit Off and On. For each combination, the probe must be active to find the worst case condition.

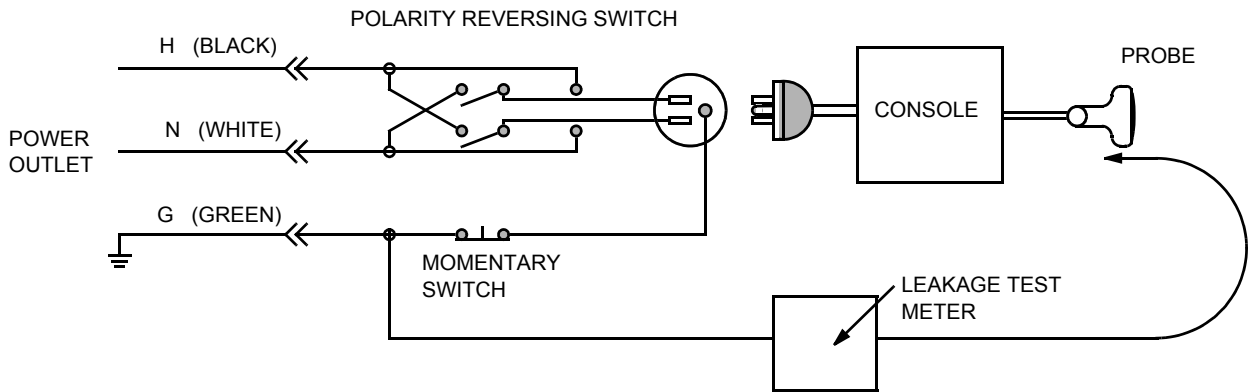

Figure 10-4 Set Up for Probe Leakage Current

NOTE: Each probe will have some amount of leakage current, dependent on its design. Small variations in probe leakage currents are normal from probe to probe. Other variations will result from differences in line voltage and test lead placement.

10-6-5-3 Meter Procedure Using Probe Adapter

Follow the Safety Analyzer tool instruction to test each transducer for leakage current.

The electrical Safety Analyzer tool should be calibrated and compliant with AAMI/ESI 1993 or IEC 60601 or AS/NZS 3551.

10-6-5-4 No Meter Probe Adapter Procedure

Follow the Safety Analyzer tool instruction to test each transducer for leakage current.

The electrical Safety Analyzer tool should be calibrated and compliant with AAMI/ESI 1993 or IEC 60601 or AS/NZS 3551.

10-6-5-5 Data Sheet for Transducer Source Leakage Current

The test passes when all readings measure less than the values shown in [Table 10-11](#). Record all data on the PM Inspection Certificate.



CAUTION Equipment damage possibility. Never switch the Polarity and the status of Neutral when the unit is powered ON. Be sure to turn the unit power OFF before switching them using the POLARITY switch and/or the NEUTRAL switch. Otherwise, the unit may be damaged

Table 10-15 Typical Data Sheet For Transducer Source Leakage Current

Transducer Tested:			
Unit Power	Tester Power Polarity Switch	Tester GROUND or NUETRAL Switch	Measurement
ON	NORM	OPEN	
ON	NORM	CLOSED	
ON	REV	OPEN	
ON	REV	CLOSED	
OFF	NORM	OPEN	
OFF	NORM	CLOSED	
OFF	REV	OPEN	
OFF	REV	CLOSED	

Section 10-7 When There's Too Much Leakage Current...

AC/DC FAILS

Check any broken of the AC/DC adapter and its cable. Replace a new one if any portion defective.

ENCLOSURE FAILS

Check any broken of the enclosure. Replace any defective part.

Inspect wiring for bad crimps, poor connections, or damage.

Test the wall outlet; verify it is grounded and is free of other wiring abnormalities. Notify the user or owner to correct any deviations. As a work around, check the other outlets to see if they could be used instead.

NOTE: *No outlet tester can detect the condition where the white neutral wire and the green grounding wire are reversed. If later tests indicate high leakage currents, this should be suspected as a possible cause and the outlet wiring should be visually inspected.*

PROBE FAILS

Change another probe to confirm if the fail is caused by console.

NOTE: *Each probe will have some amount of leakage, dependent on its design. Small variations in probe leakage currents are normal from probe to probe. Other variations will result from differences in line voltage and test lead placement. The maximum allowable leakage current for body surface contact probe differs from inter-cavity probe. Be sure to enter the correct probe type in the appropriate space on the check list.*

If excessive leakage current is slot dependent, inspect the system connector for bent pins, poor connections, and ground continuity.

If the problem remains with the probe, replace the probe.

PERIPHERAL FAILS

Inspect wiring for bad crimps, poor connections, or damage.

STILL FAILS

If all else fails, begin isolation by removing the probes, external peripherals, then the on board ones, one at a time while monitoring the leakage current measurement.

NEW UNIT

If the leakage current measurement tests fail on a new unit and if situation can not be corrected, submit a Safety Failure Report to document the system problem. Remove unit from operation.

ULTRASOUND INSPECTION CERTIFICATE

Customer Name:		System ID:	Dispatch Number / Date Performed:	Warranty/Contract/HBS
System Type		Model Number:	Serial Number:	Manufacture Date:
Probe 1:	Frequency:	Scan Format*:	Model Number:	Serial Number:
Probe 2:	Frequency:	Scan Format*:	Model Number:	Serial Number:
Probe 3:	Frequency:	Scan Format*:	Model Number:	Serial Number:
Probe 4:	Frequency:	Scan Format*:	Model Number:	Serial Number:
Probe 5:	Frequency:	Scan Format*:	Model Number:	Serial Number:

* Scan Format: Phased Array, Linear Array, Curved Array, Mechanical Array or Other

FUNCTIONAL CHECKS

PHYSICAL INSPECTION AND CLEANING

Functional Check (if applicable)	OK? or N/A
B-Mode Function	
Doppler Modes Function	
CF-Mode Function	
M-Mode Function	
Applicable Software Options	
Applicable Hardware Options	
Control Panel	
LCD	
Measurement Accuracy	
GE Approved Peripherals	

Physical Inspection and Cleaning (if applicable)	Inspect	Clean
Console		
LCD		
External I/O		
Cables and Connectors		
GE Approved Peripherals (CD-RW, Printer)		
Labeling (see User Manual for Labeling)		

COMMENTS:

ELECTRICAL SAFETY

Electrical Test Performed	Max Value Allowed	Value Measured	OK?	Comments
Outlet (correct ground & wiring config.)				
Type BF Applied Part Leakage Current Limits- Probe				
enclosure Source Leakage Current - Chassis Leakage Current Limits				
Peripheral 1 Leakage Current				
Peripheral 2 Leakage Current				

PROBES

Probe Number (from previous page)	Max Value Allowed	Max Value Measured	OK?	Comments
Probe 1:				
Probe 2:				
Probe 3:				

Final Check. All system covers are in place. System scans with all probes as expected.

Accepted by: _____

INDEX

A,B

Abbreviations, 9-1
Archiving Images
 Move, 4-30
Backup
 Patient Database, 4-27
 Preset Configurations, 4-27
Basic Measurements
 Functional Checks, 4-24
Body pattern
 display location, 4-9
Boot Up, 3-9

C

Caps lock
 display location, 4-9
CE Compliance, 1-13
Cine gauge
 display location, 4-9
Color Mode
 Overview, 4-20
Configuration, 5-32
Connectivity
 Worksheet, 3-27
Contact Information, 1-14
Control Panel, 4-7
Conventions
 Conventions Used in Book, 1-3
Customer Assistance, 1-14

D

Dangerous Procedure Warnings, 1-11
Date/Time
 display location, 4-9
Depth scale
 display location, 4-9
Diagnostics, 5-30
DICOM Network Function, 2-9

E

Electrical
 requirements, 2-2
Electrical Safety, 1-9
Electrostatic Discharge Warning, 1-13
EMI, 1-13
ESD, 1-13
Exam study

display location, 4-9

F

Focal zone
 display location, 4-9
Functional Checks
 Basic Measurements, 4-24
 Control Panel, 4-7
 Image Management, 4-26
 Monitor Display, 4-9
 Peripherals, 4-32
 Probes/Connector Usage, 4-25

G

Gathering Trouble Data, 7-2
General Cleaning, 10-7
Gray/color bar
 display location, 4-9

H

Hazard Icons, 1-4
Hospital name
 display location, 4-9
Human Safety, 1-8

I

Image Management
 Functional Checks, 4-26
Image preview
 display location, 4-9
Imaging parameters
 display location, 4-9
Inrush Current, 2-2, , 2-3
Institution name
 display location, 4-9

L

Logs, 5-27

M

Measurement summary window
 display location, 4-9
Mechanical Safety, 1-8

INDEX

Media

Formatting, 4-27

Monitor Display

Functional Checks, 4-9

Monitor display

location, 4-9

Move

Archiving Images, 4-30

O

Operator identification

display location, 4-9

P

P4 Key Function, 7-4

Patient identification

display location, 4-9

Patient name

display location, 4-9

PC Diagnostics, 7-18

CD/DVD Drive Test, 7-18

CPU Tests, 7-18

Hard Drive Tests, 7-18

Keyboard Test, 7-18

Memory Tests, 7-18

Monitor Test, 7-18

USB Test, 7-18

Video Test, 7-18

PC Diagnostics (Interactive Tests), 7-18

Peripherals

Functional Checks, 4-32

Power On, 3-9

Power Requirements, 2-2

electrical, 2-2

stability, 2-3

Power Stability Requirements, 2-3

Probe Connector Cleaning, 10-9

Probe identifier

display location, 4-9

Probe orientation marker

display location, 4-9

Probes/Connector Usage

Functional Checks, 4-25

R

Required Features, 2-7

Restore

Patient Database, 4-29

Preset Configurations, 4-29

S

Safety Considerations, 1-8

Screen Captures, 7-4

System Maintenance, 10-5

System Manufacturer, 1-15

System messages

display location, 4-9

T

TGC

display location, 4-9

Touch Panel

Functional Checks, 4-7

Trouble Image with Logs, 7-3

Troubleshooting

Gathering Trouble Data, 7-2

Screen Captures, 7-4

Trouble Image with Logs, 7-3

Vital System Information, 7-2

U

Utilities, 5-32

W

Warnings and Cautions, 1-8

© 2004 to 2012, General Electric Company.

GE Medical Systems, a General Electric Company, going to market as GE Healthcare.

[3200 N. Grandview Boulevard](#)

[Waukesha, Wisconsin 53149](#)

[USA](#)

www.gehealthcare.com

