

# COULTER® AC•T Series Analyzer

## Special Procedures and Troubleshooting



READ ALL PRODUCT MANUALS AND CONSULT WITH COULTER-TRAINED PERSONNEL  
BEFORE ATTEMPTING TO OPERATE INSTRUMENT.

**HAZARDS AND OPERATIONAL PRECAUTIONS AND LIMITATIONS**

WARNINGS, CAUTIONS, and IMPORTANTS alert you as follows:

- WARNING** - Might cause injury.  
**CAUTION** - Might cause damage to the instrument.  
**IMPORTANT** - Might cause misleading results.

---

**CAUTION** System integrity might be compromised and operational failures might occur if:

- This equipment is used in a manner other than specified. Operate the instrument as instructed in the Product Manuals.
  - You introduce software that is not authorized by Coulter into your computer. Only operate your system's computer with software authorized by Coulter.
  - You install software that is not an original copyrighted version. Only use software that is an original copyrighted version to prevent virus contamination.
- 

Coulter Corporation urges its customers to comply with all national health and safety standards such as the use of barrier protection. This may include, but it is not limited to, protective eyewear, gloves, and suitable laboratory attire when operating or maintaining this or any other automated laboratory analyzer.

‡	<b>This symbol indicates that, at the time of instrument release, this product was not available.</b>
---	---

# B

## REVISION STATUS



Initial Issue 9/96

Software Version 1.00.

Issue B, 3/97

Software Version 1.04. Due to additions and deletions of material, pagination changed for some of this manual. Actual text changes, noted by change bars, occurred on pages: i, v, 1-2, 1-7, 2-1, 2-4, 2-5, 3-13, 3-33 through 3-37 and INDEX-1 through INDEX-6.

Note: Changes that are part of the most recent revision are indicated by a black bar in the margin fo the amended page.

*This document applies to the latest software listed and higher versions. When a subsequent software version changes the information in this document, a new issue will be released.*

**A** | **REVISION STATUS**

# CONTENTS

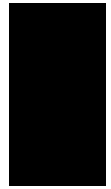

REVISION STATUS, i

INTRODUCTION, vii

HOW TO USE YOUR COULTER AC•T MANUALS, vii

ABOUT THIS MANUAL, viii

CONVENTIONS, viii

SYMBOLS, ix

SCREEN ICONS, xi

Main Screen Icons, xi

Setup Screen Icons, xii

Diluter Functions Screen Icons, xiii

Diagnostic Functions Screen Icons, xiv

Sample Results Screen Icons, xv

Sample ID Screen Icons, xv

1 PREVENTIVE MAINTENANCE PROCEDURES, 1-1

1.1 GENERAL MAINTENANCE, 1-1

1.2 MAINTENANCE SCHEDULE, 1-2

1.3 CLEANING PROCEDURES, 1-5

Zap Apertures, 1-5

Clean the Baths, 1-6

Additional Cleaning Procedures, 1-6

1.4 CALIBRATION PROCEDURES, 1-7

Preliminary Procedures, 1-7

Reproducibility/Carryover Check, 1-8

S-CAL Calibrator Kit Calibration, 1-9

Calibration Procedure, 1-10

Calculations, 1-10

Does the Instrument Require Calibration?, 1-11

Calculating New Calibration Factors, 1-12

Verifying that Calibration is Acceptable, 1-13

CALIBRATION WORKSHEET, 1-14

## CONTENTS

- 1.5 A<sup>C</sup>•T COMPONENT LOCATIONS, 1-15
- 2 REPLACE/ADJUST PROCEDURES, 2-1
  - 2.1 REPLACING REAGENTS, 2-1
    - Replace the A<sup>C</sup>•T Pak, 2-1
    - Replace the Ac •T Rinse Shutdown Diluent, 2-3
    - Replace the A<sup>C</sup>•T Tainer, 2-4
  - 2.2 REPLACING THE WASTE CONTAINER, 2-6
  - 2.3 REPLACING DILUENT FILTERS, 2-7
  - 2.4 REPLACING PERISTALTIC PUMP TUBING, 2-9
  - 2.5 REPLACING CHECK VALVES, 2-13
  - 2.6 REPLACING TUBING, 2-15
  - 2.7 REPLACING FUSES, 2-16
  - 2.8 REPLACING VACUUM ISOLATOR CHAMBER, 2-17
  - 2.9 REPLACING SYRINGE PISTONS AND SEALS, 2-22
  - 2.10 REPLACING THE PROBE WIPE, 2-26
  - 2.11 PREPARING TO SHIP THE INSTRUMENT, 2-29
- 3 TROUBLESHOOTING, 3-1
  - 3.1 TROUBLESHOOTING TOOLS, 3-1
    - Diluter Functions, 3-2
    - Diagnostic Functions, 3-4
  - 3.2 WHAT FLAGS MEAN, 3-7
  - 3.3 WHAT WARNING MESSAGES MEAN, 3-15
  - 3.4 FATAL ERRORS , 3-17
  - 3.5 TROUBLESHOOTING GUIDES, 3-21

INDEX, INDEX-1

COULTER® A<sup>C</sup>•T SERIES DOCUMENTATION PAGE

## ILLUSTRATIONS

- 1.1 Maintenance Schedule, 1-2
- 3.1 Diluter Functions Screen, 3-2
- 3.2 Diagnostic Functions Screen, 3-4
- 3.3 What Flags Mean, 3-7
- 3.4 Warning Messages, 3-15
- 3.5 Fatal Errors, 3-17
- 3.6 Power Problems, 3-21
- 3.7 Aspiration Problems, 3-23
- 3.8 Background Problems, 3-25
- 3.9 Irregular Sample Results, 3-29
- 3.10 A<sup>C</sup>•T Tron<sup>+</sup> Cell Control Results, 3-35



**CONTENTS**



This introductory section contains the following topics:

- How to use your COULTER® A<sup>C</sup>•T Series analyzer manuals
- About this Manual
- Conventions
- Symbols
- Screen Icons

## HOW TO USE YOUR COULTER A<sup>C</sup>•T MANUALS

Use the **Getting Started** manual to install and learn to operate your A<sup>C</sup>•T Series Analyzer.

Use the **Operator's Guide** for running your instrument day-to-day.

Use the **Special Procedures and Troubleshooting** manual for:

- Cleaning, replacing, or adjusting a component of the instrument.
- Reviewing unusual results (how to read a result report and what flags mean).
- Troubleshooting problems with your instrument.

Use the **Reference** manual for in-depth information about:

- What the instrument does
- What methods the instrument uses
- Instrument specifications
- Safe usage.

Use the **Host Transmission Specification** manual to:

- Find the information needed to program the transmission interface between your A<sup>C</sup>•T Series instrument and your laboratory's host computer.

## **ABOUT THIS MANUAL**

Your COULTER A<sup>C</sup>•T **Special Procedures and Troubleshooting** manual provides step-by-step instructions for performing general and preventive maintenance on your instrument.

- **Preventive Maintenance Procedures** provides a maintenance schedule for performing daily and preventive maintenance on your A<sup>C</sup>•T and for periodic cleaning procedures.
- **Replace/Adjust Procedures** provides step-by-step procedures for replacing reagents and components on your A<sup>C</sup>•T.
- **Troubleshooting** explains the troubleshooting tools provided on the A<sup>C</sup>•T, the meaning of flags on sample results, what actions to take for warning and fatal messages, and how to isolate problems by studying irregular results.

## **CONVENTIONS**

This manual uses the following conventions:

**Bold** indicates A<sup>C</sup>•T manual names.

**Bold** indicates a screen icon.

## SYMBOLS



Wear standard laboratory attire.



Keep hands away from probe area. Probe moves up and down.



Unplug the A<sup>C</sup>•T before continuing.



Go to.



For further information, see the **Special Procedures and Troubleshooting** manual.

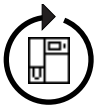

X,XXX

Replace the component at the specified number of cycles, for example, 12,000.



Fatal error. Turn the power off, then on again. See Table 3-5.



Biohazardous waste disposal receptacle.



**INTRODUCTION**  
*SYMBOLS*









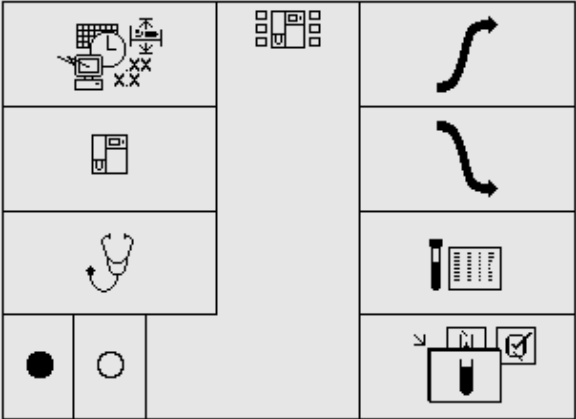



This symbol indicates that, at the time of instrument release, this product was not available.

**SCREEN ICONS**

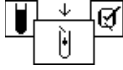
**Main Screen Icons**



7289126A

	
Setup	Shutdown
	
Diluter Functions	Sample Results Screen
	
Diagnostic Functions	Analyzing Mode
	
Darken Screen	Whole Blood Mode
	
Lighten Screen	Predilute Mode
	
Startup	AC•T Tron Mode†

**INTRODUCTION**  
**SCREEN ICONS**



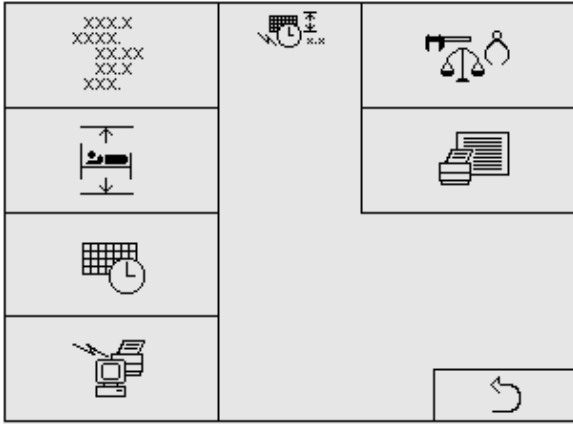







**Setup Screen Icons**













7289127A

Units	Calibration Factors
Patient Limits	Print Setup Report
Date/Time	Exit
Transmission	

**Diluter Functions Screen Icons**

			
			
			
			







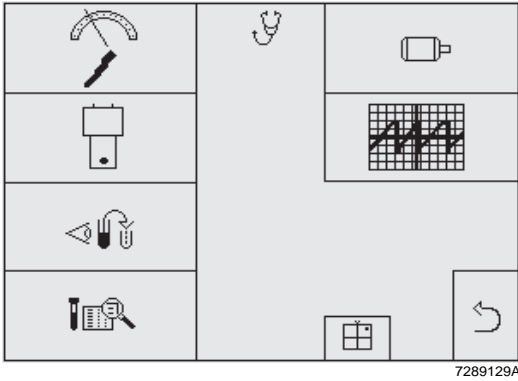

7289128A

	
Wet Prime	Dispense Lytic Reagent
	
Drain Baths	Prime Sweepflow
	
Rinse + Mix	Zap Apertures
	
Dry Prime Lytic Reagent	Clean Baths
	
Dry Prime Diluent	Exit

**INTRODUCTION**  
**SCREEN ICONS**

**Diagnostic Functions Screen Icons**







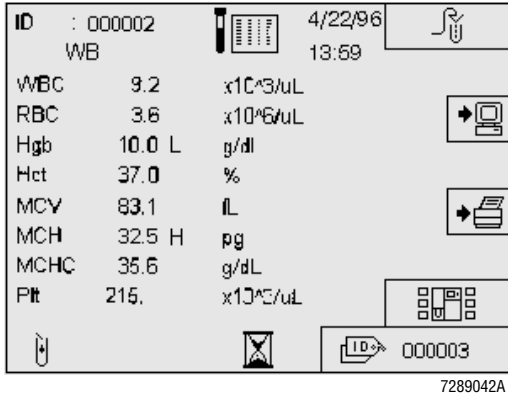

	
Voltages/Sensors	Motors
	
Solenoids	Pulse
	
Verify Predilute	Exit
	
Sample Details	Prepare to Ship









**Sample Results Screen Icons**



	
Dispense Diluent	Go to Main Screen
	
Resend to Host	Enter Sample ID
	
Print Sample Results	In Progress

**Sample ID Screen Icons**

1	2	3	 000002
4	5	6	
7	8	9	0
			

	
Delete	Exit
	
Save and Exit	



**INTRODUCTION**  
*SCREEN ICONS*

# PREVENTIVE MAINTENANCE PROCEDURES

## 1.1 GENERAL MAINTENANCE

This manual details the A<sup>C</sup>•T maintenance procedures that are your responsibility. It also includes (as Chapter 3) a troubleshooting guide to help you solve instrument problems.

You perform maintenance procedures either on a time schedule or on an A<sup>C</sup>•T cycle schedule. Keep a calendar marked with dates for maintenance and check the date/time screen for the number of cycles performed.

---

**CAUTION** Incorrectly performed maintenance procedures can damage the A<sup>C</sup>•T. Do not attempt any procedures that are not included in this manual or in the A<sup>C</sup>•T replacement cards. Call your Coulter Representative for service and maintenance beyond the scope of Coulter documentation.

---

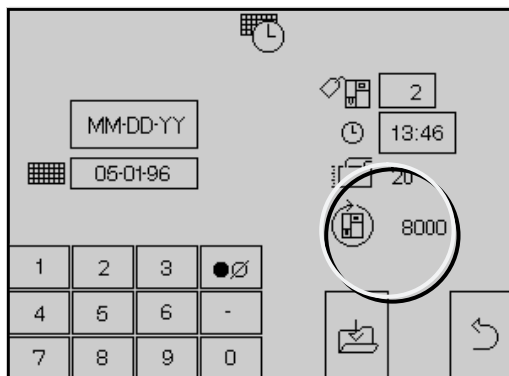







# B









## PREVENTIVE MAINTENANCE PROCEDURES MAINTENANCE SCHEDULE

### 1.2 MAINTENANCE SCHEDULE

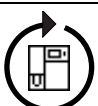
Table 1.1 Maintenance Schedule

Maintenance Procedure	Frequency	Situation
Startup 	Daily	<ul style="list-style-type: none"> <li>■ Coming out of Shutdown (you touch the <b>continue</b> icon on the screen).</li> <li>■ Automatically occurs when powering up after turning the power off during a cycle or after a power interruption during a cycle.</li> <li>■ Automatically occurs when powering on more than 2 hours after the previous sample was run.</li> </ul>
Shutdown 	Daily	You run Shutdown to clean the instrument.
Clean the baths 	When necessary	<ul style="list-style-type: none"> <li>■ Before any type of calibration.</li> <li>■ Increased voteouts.</li> <li>■ Decreased cell counts.</li> <li>■ Increased MCV values.</li> <li>■ Failure to recover control values.</li> <li>■ Erratic MCV, RBC and WBC counts.</li> </ul>
Calibration 	When necessary or as required by your regulatory agency	<ul style="list-style-type: none"> <li>■ After replacing major component parts such as an aperture bath assembly.</li> <li>■ When control values are consistently out of expected assay range.</li> </ul>
Replace check valve 	When defective	Clogged or lets liquid or air flow both ways.
Replace fuses 	When blown	<ul style="list-style-type: none"> <li>■ No power. Green power LED is not lit.</li> <li>■ Instrument is plugged in but does not run.</li> </ul>

**Table 1.1** Maintenance Schedule (*Continued*)

Maintenance Procedure	Frequency	Situation
Replace diluent filters 	 <b>12,000</b>	<ul style="list-style-type: none"> <li>■ Every 12,000 cycles when you replace peristaltic pump tubing.</li> <li>■ When a filter is clogged.</li> <li>■ When you get excessive diluent empty messages.</li> </ul>
Replace peristaltic pump tubing 	 <b>12,000</b>	<ul style="list-style-type: none"> <li>■ Every 12,000 cycles when you replace diluent filters.</li> <li>■ Tubing is worn to the extent that it looks almost worn through.</li> <li>■ You get excessive diluent empty messages.</li> </ul>
Replace syringe pistons and seals 	 <b>12,000</b>	<ul style="list-style-type: none"> <li>■ Excessive fluid leaks.</li> <li>■ If you see fluid leaking.</li> </ul>
Replace probe wipe block 	When defective or plugged.	Fluid drips from probe wipe but vacuum is good and instrument works.
Replace tubing 	Every 3 years	When cracked, leaking or has lost resilience.
Replace vacuum isolator chamber 	When defective	<ul style="list-style-type: none"> <li>■ When you cannot get it clean.</li> <li>■ When it is cracked or damaged or creating a vacuum leak.</li> <li>■ If there is buildup under the top, causing Plt and WBC noise problems.</li> </ul>

**PREVENTIVE MAINTENANCE PROCEDURES**  
*MAINTENANCE SCHEDULE*

**Table 1.1** Maintenance Schedule *(Continued)*

<b>Maintenance Procedure</b>	<b>Frequency</b>	<b>Situation</b>
Replace reagents 	When empty	When instrument reports empty and the container is empty.

### 1.3 CLEANING PROCEDURES

These are not routine procedures. Use them only if necessary for troubleshooting or before calibrating.

#### Zap Apertures

Zap the apertures when the instrument:

- Produces increased Aperture Alerts.
- Produces increased voteouts.
- Produces decreased cell counts.
- Produces increased MCV values.
- Fails to recover control values
- Produces erratic MCV, RBC and WBC counts.

1

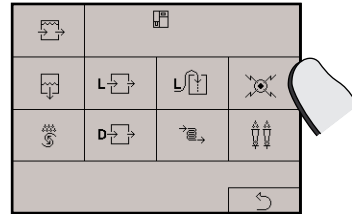
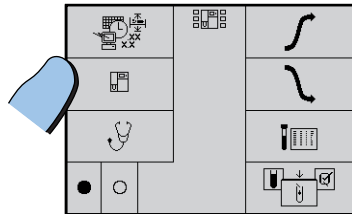

2

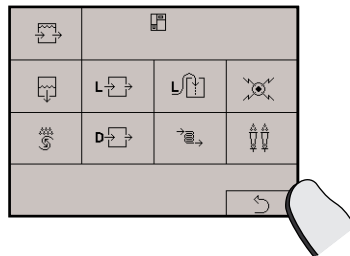

**PREVENTIVE MAINTENANCE PROCEDURES**  
**CLEANING PROCEDURES**

**Clean the Baths**

Bleaching removes any clog or debris that restricts proper sample flow. Occasionally, you must do this procedure for troubleshooting.

- 1 Fill a container (from which the A<sup>C</sup>•T can aspirate) with more than 1 mL of commercially available bleach.

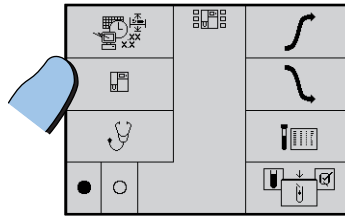

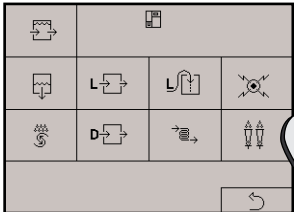
- 2 

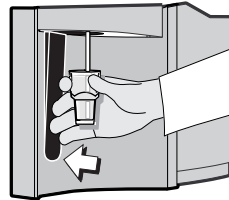

- 3 

- 4 Wait 15 minutes. You can stop the cleaning process at any time by touching the **stop** icon.

However, to perform the entire Clean Baths procedure, wait until the Diluter Functions screen appears again.

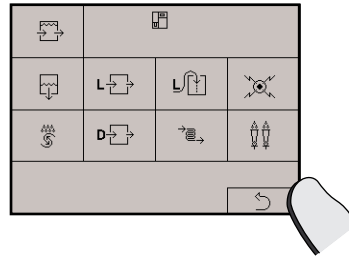

**Additional Cleaning Procedures**

Clean the outside of the instrument with a damp cloth and distilled water. This prevents the buildup of corrosive deposits. Clean up spills promptly. Pay particular attention to the probe wipe housing.



## 1.4 CALIBRATION PROCEDURES

Coulter calibrates the A<sup>C</sup>•T Series system at the factory before shipment. You may need to perform calibration procedures when you replace any A<sup>C</sup>•T component that involves the primary measurement characteristics (such as an aperture). Coulter recommends that you calibrate your instrument according to the regulations required by your inspecting agency with COULTER S-CAL<sup>®</sup> calibrator or do a whole-blood calibration with normal, fresh, whole blood.

Because the instrument is electronically stable, it should not require frequent recalibration when you operate it and maintain it according to the recommendations in this manual. Make the decision to recalibrate based on the performance of your quality-control program.

Your laboratory's quality-control program should continually monitor and confirm instrument calibration. Review your control results periodically. Keep a written record of this review. To confirm calibration of the A<sup>C</sup>•T system, verify that 95% of control results are within their ranges listed in the TABLE OF EXPECTED RESULTS and there are no unexplained shifts or trends in the data.

If recalibration appears necessary, but you have not replaced a component affecting calibration, do NOT recalibrate the instrument. First, thoroughly clean your analyzer following the clean baths procedure (Heading 1.3). Then reanalyze a new vial of control material. If the control results are still outside of the expected ranges, call your Coulter Representative before recalibrating.

When necessary, perform calibration by following the procedures given in this section.

### Preliminary Procedures

- 1** Ensure that all required maintenance (including replacement of parts) has been performed on the instrument. See Table 1-1 for Maintenance schedule.
- 2** Clean the baths according to the information in Heading 1.3, Clean the Baths.
- 3** Calibrate only within the ambient temperature (20-25°C).
- 4** Before you begin these calibration procedures, shut down your instrument in COULTER A<sup>C</sup>•T Rinse shutdown diluent.
- 5** Check that you have a sufficient supply of reagents to complete this procedure.
- 6** Perform Startup.

**PREVENTIVE MAINTENANCE PROCEDURES**  
*CALIBRATION PROCEDURES*

**Reproducibility/Carryover Check**

Reproducibility is a check to ensure that the instrument measures blood parameters consistently.

- 1** Set Analyzing mode to whole blood.
- 2** Cycle one fresh, normal, properly mixed, whole-blood sample to prime the instrument.
- 3** Analyze 1 fresh, normal, properly mixed whole-blood specimen 10 times.
- 4** Record results for WBC, RBC, Hgb, MCV and Plt from the 10 cycles.
- 5** With a scientific calculator, calculate the mean, standard deviation and CV% for WBC, RBC, Hgb, MCV and Plt. The CV% should be less than or equal to those listed.

$$\text{Note: CV\%} = \frac{\text{standard deviation}}{\text{mean}} \times 100$$

**Precision Limits for 10 Replicate Samples Coefficient of Variation**

Parameters	Coefficient of Variation
WBC at 6.0 - 15.0 x 10 <sup>3</sup> cells/μL	≤3.0%
RBC at 3.00 - 6.00 x 10 <sup>6</sup> cells/μL	≤3.0%
Hgb at 12.0 - 18.0 g/dL	≤2.0%
MCV at 80.0 - 100.0 fL	≤2.0%
Plt at 200 - 500 x 10 <sup>3</sup> cells/μL	≤7.0%

If the CV% for any parameter is greater than those listed, you might have an instrument problem. Call your Coulter Representative.

- 6** Review each parameter for trending (a gradual and consistent increase or decrease in values). If you think a trend exists, you might have an instrument problem; call your Coulter Representative.
- 7** Record the results in your laboratory's logbook.

- 8** Perform the Carryover check. Carryover is a check to ensure that no part of the sample is carried over to the next sample, thus affecting the next sample's results.
- a. Press the aspirate switch three times, recording the results from each of the three cycles.
  - b. Using the following formula, compute the carryover for WBC, RBC, Hgb, and Plt:

$$\text{Carryover} = \frac{\text{first cycle} - \text{third cycle}}{\text{result \#10 reproducibility check}} \times 100$$

- c. The results must not exceed the following values:

Parameter	Carryover (%)
WBC	≤2.0
RBC	≤2.0
Hgb	≤2.0
Plt	≤2.0

- d. Record the results in your laboratory's logbook.

### **S-CAL Calibrator Kit Calibration**

The S-CAL calibration kit helps you determine whether the calibration factors of the instrument need to be changed. Assigned values are provided in the S-CAL calibration kit package insert. The calibration procedure requires the use of the S-CAL calibration worksheet in this section. Only the package inserts provided with the S-CAL calibration kit provide the correct assigned values for the calibrator.

Complete the preliminary procedures, reproducibility check and carryover check before beginning calibration.

Prepare the S-CAL calibrator according to the instructions in the S-CAL calibrator package insert.



- 3 Calculate the absolute difference between the assigned value and the mean value calculated above. Write this number into row C of the calibration worksheet.

### Does the Instrument Require Calibration?

- 1 To determine calibration status for each parameter, compare the absolute difference to the A<sup>C</sup>•T Series Calibration criteria table located in the S-CAL calibrator kit.
- 2 If the absolute difference is less than the value in column 1, no calibration is required. You have verified the calibration of this parameter.
- 3 If the absolute difference is between the values found in column 1 and column 2, calibration is required. Proceed to step 1 under Calculating New Calibration Factors.
- 4 If the absolute difference is greater than the value found in column 2, review all calculations, eliminate possible instrument problems and S-CAL calibrator deterioration before you proceed with calibration. If you cannot determine whether a problem exists, call your Coulter Representative.

**PREVENTIVE MAINTENANCE PROCEDURES**  
**CALIBRATION PROCEDURES**

**Calculating New Calibration Factors**

- 1 For the parameters that require calibration, obtain the current calibration factors that are in memory in the instrument.

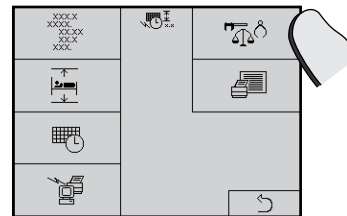
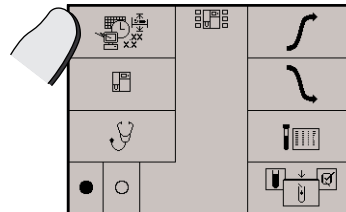

- 2 Write these factors down on the S-CAL calibration worksheet under current calibration factor.
- 3 Calculate new calibration factor by dividing the assigned value by the mean value; then multiply this number by the current calibration factor.

$$\text{new calibration factor} = \frac{\text{assigned value (B)}}{\text{mean value (A)}} \times \text{current calibration factor}$$

- 4 Enter the new values on the Calibration Factors screen in the instrument.

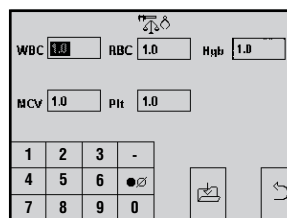

### Verifying that Calibration is Acceptable

- 1** Analyze 4C<sup>®</sup> PLUS cell control, A<sup>C</sup>•TTron<sup>‡</sup> cell control, whole blood with known values or other quality control material.
  
- 2** The control results should fall within the expected ranges.
  
- 3** If the control results are not within the expected ranges, run one more sample. If the results of the second sample are not within the expected range, follow the Investigational Procedure in the control package insert and call your Coulter Representative.

**PREVENTIVE MAINTENANCE PROCEDURES**  
*CALIBRATION PROCEDURES*

**CALIBRATION WORKSHEET**

Sample Number	WBC	RBC	Hgb	MCV	Plt
1					
2					
3					
4					
5					
6					
7					
8					
9					
10					
11					
<b>TOTAL</b>					
<b>MEAN (A)</b>					
<b>ASSIGNED VALUE (B)</b>					
<b>ABSOLUTE DIFFERENCE (C)</b>					
<b>CALIBRATION REQUIRED</b>					
<b>CURRENT CALIBRATION FACTOR (D)</b>					
<b>NEW CALIBRATION FACTOR (E)</b>					

**A = samples 2 through 11**

**C = B - A**

**E = (B / A) x D**

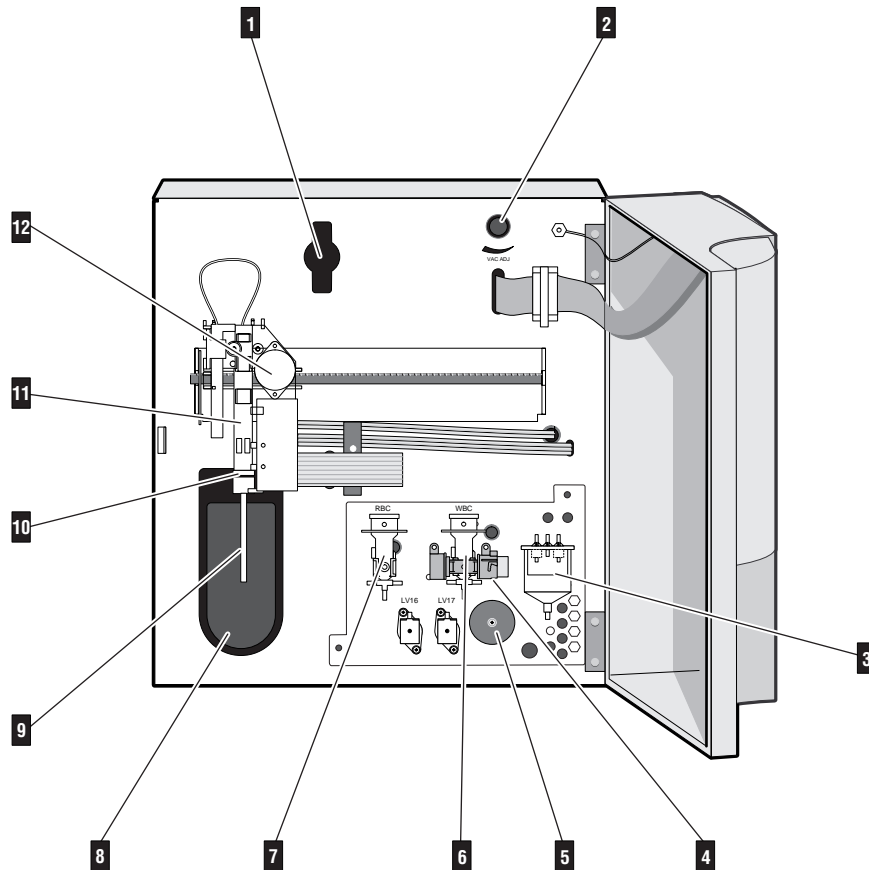

1.5 A<sup>C</sup>•T COMPONENT LOCATIONS

- |                                  |  |
|----------------------------------|--|
| <b>1</b> Software Card Slot      | <b>7</b> RBC Bath                      |
| <b>2</b> Vacuum Adjust           | <b>8</b> Aspirate Switch               |
| <b>3</b> Vacuum Isolator Chamber | <b>9</b> Probe                         |
| <b>4</b> Hgb Lamp                | <b>10</b> Probe Wipe Block             |
| <b>5</b> Sweepflow Spool         | <b>11</b> Horizontal Traverse Assembly |
| <b>6</b> WBC Bath                | <b>12</b> Horizontal Traverse Motor    |

**PREVENTIVE MAINTENANCE PROCEDURES**  
*A<sup>c</sup>•T COMPONENT LOCATIONS*

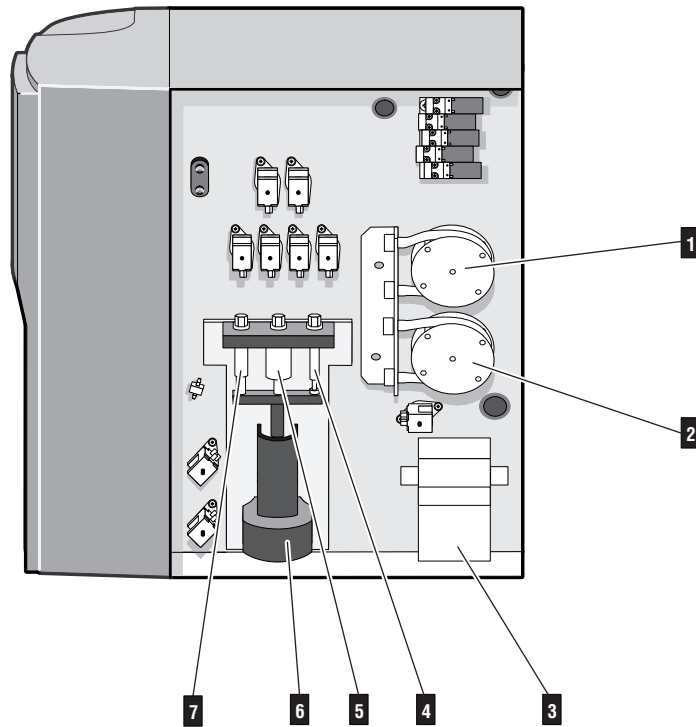

7314115A

- |                                       |                                       |
|---------------------------------------|---------------------------------------|
| <b>1</b> Waste/Rinse Pump             | <b>5</b> Diluent Syringe (5 mL)       |
| <b>2</b> Diluent Pump                 | <b>6</b> Syringe Module               |
| <b>3</b> Diluent Reservoir            | <b>7</b> Lytic Reagent Syringe (1 mL) |
| <b>4</b> Aspiration Syringe (0.25 mL) |                                       |

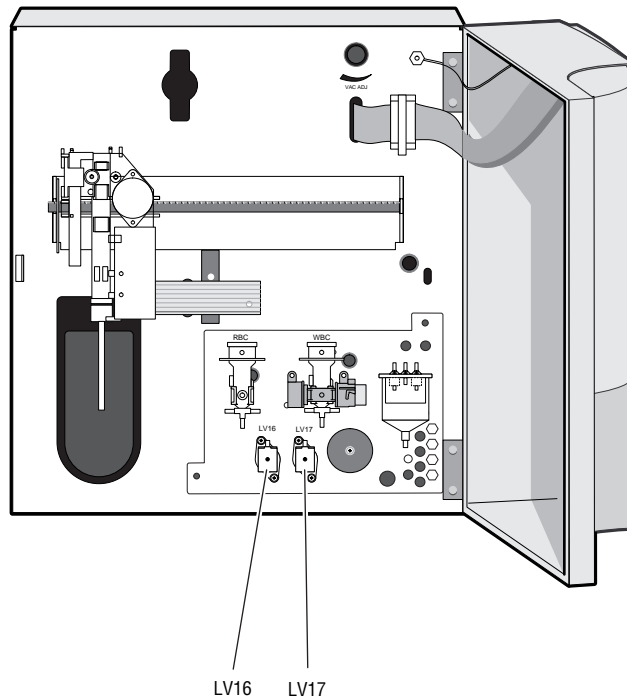

7314116A

**LV16** On = Opens count path from RBC bath.  
OFF = Closes count path from RBC bath.

**LV17** ON = Opens count path from WBC bath.  
OFF = Closes count path from WBC bath.

**PREVENTIVE MAINTENANCE PROCEDURES**  
*A<sup>c</sup>•T COMPONENT LOCATIONS*

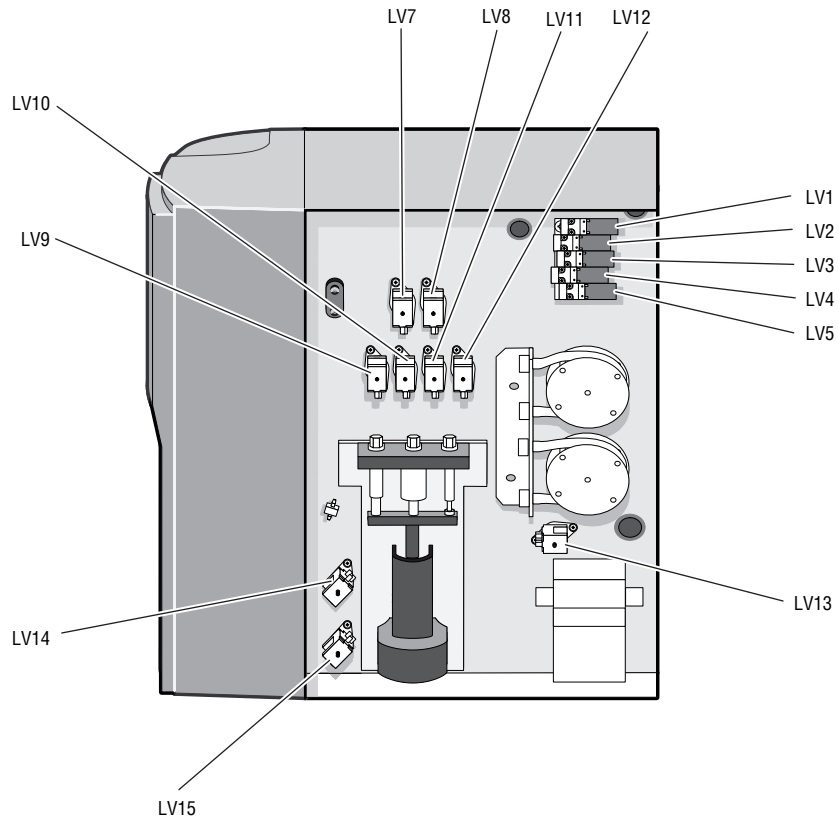

7314117A

**PREVENTIVE MAINTENANCE PROCEDURES**  
*A<sup>c</sup>•T COMPONENT LOCATIONS*

**1**

- |            |  |             |  |
|------------|--|-------------|--|
| <b>LV1</b> | Open top of Vacuum Isolator Chamber to vent.   | <b>LV9</b>  | ON = Lytic reagent syringe connected to bath.<br>OFF = Lytic reagent syringe connected to lytic reagent source.                  |
| <b>LV2</b> | ON = High vacuum.<br>OFF = Low vacuum.   | <b>LV10</b> | ON = Diluent pump goes to the probe wash.<br>OFF = Diluent pump goes to the diluent reservoir.                                   |
| <b>LV3</b> | ON = Sends mixing bubbles to the WBC bath.<br>OFF = Sends mixing bubbles to the RBC bath.                            | <b>LV11</b> | ON = Diluent from the syringe goes to LV7 (bath prefill).<br>OFF = Probe connected to syringes for aspirate or diluent dispense. |
| <b>LV4</b> | ON = side of WBC bath.<br>OFF = bottom of WBC bath.  | <b>LV12</b> | ON = Diluent syringe connected to aspirate syringe.<br>OFF = Diluent syringe connected to diluent reservoir.                     |
| <b>LV5</b> | ON = Vacuum pump vent sending mixing bubbles.<br>OFF = Vacuum pump venting to atmosphere.                            | <b>LV13</b> | ON = Waste pump inputs from cleaner.<br>OFF = Waste pump outputs to waste.   |
| <b>LV7</b> | ON = Prefill to RBC bath.<br>OFF = Prefill to WBC bath.  | <b>LV14</b> | ON = Drains WBC bath.<br>OFF = Drains RBC bath.  |
| <b>LV8</b> | ON = Opens probe wash drain to vacuum isolator chamber.<br>OFF = closes probe wash drain to vacuum isolator chamber. | <b>LV15</b> | ON = Drains vacuum isolator chamber.<br>OFF = Drains bath specified by LV14.   |



**PREVENTIVE MAINTENANCE PROCEDURES**  
*A<sup>c</sup>•T COMPONENT LOCATIONS*

## 2.1 REPLACING REAGENTS

Change the reagent container when you see one of these symbols:

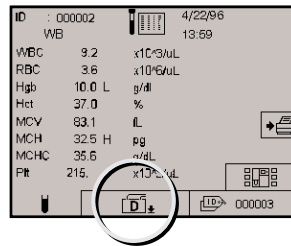
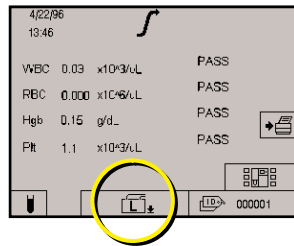

### Replace the A<sup>C</sup>•T Pak

Look at step 2. If your reagent container is like the picture, use the instructions on this page. Otherwise, use the instructions in the Replace the A<sup>C</sup>•T Tainer Heading.

- 1 Check to see if the reagent pak is empty. If the pak is not empty, touch the reagent icon on the screen to prime. If pak is empty, continue to step 2 for reagent replacement.



2

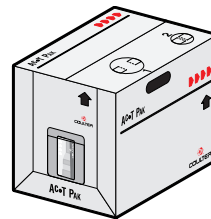
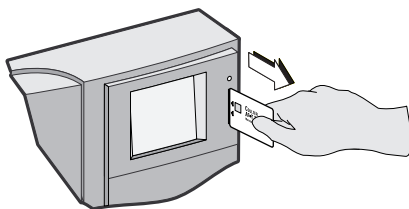

# A

## REPLACE/ADJUST PROCEDURES REPLACING REAGENTS

3

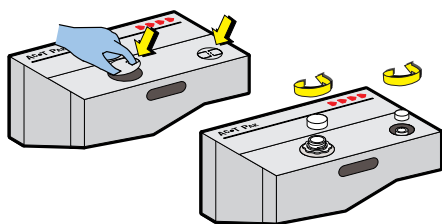

4

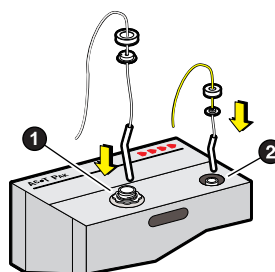
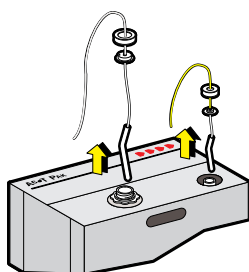

5

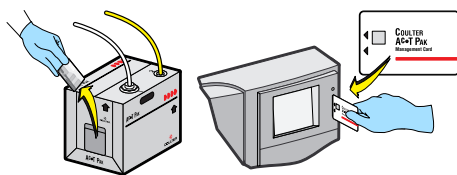

6

ID	: 000002	4/22/96
WB		13:59
WBC	9.2	$\times 10^3/\mu\text{L}$
RBC	3.6	$\times 10^6/\mu\text{L}$
Hgb	10.0	L g/dL
Hct	37.0	%
MCV	83.1	fL
MCH	32.5	pg
MCHC	35.6	g/dL
Plt	215	$\times 10^3/\mu\text{L}$
000003		

4/22/96		
13:46		
WBC	0.03	$\times 10^3/\mu\text{L}$ PASS
RBC	0.000	$\times 10^6/\mu\text{L}$ PASS
Hgb	0.15	g/dL PASS
Plt	1.1	$\times 10^3/\mu\text{L}$ PASS
000001		

7

Record the reagent lot number and expiration date from the new A<sup>C</sup>•T Pak into your laboratory's logbook.



### Replace the A<sup>C</sup>•T Rinse Shutdown Diluent

Replace the A<sup>C</sup>•T Rinse container when you see:

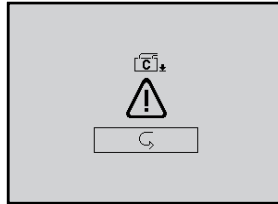

- 1 Check to see if the A<sup>C</sup>•T Rinse container is empty. If it is not empty, touch the **continue** icon to prime the rinse lines.

If it is empty, continue to step 2 to replace the A<sup>C</sup>•T Rinse container.

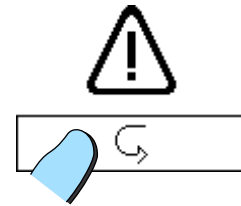

2

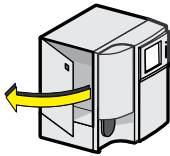

3

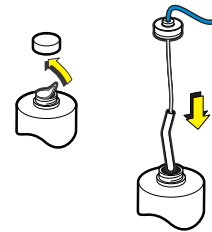
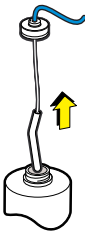

4

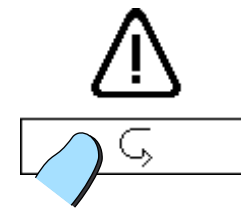
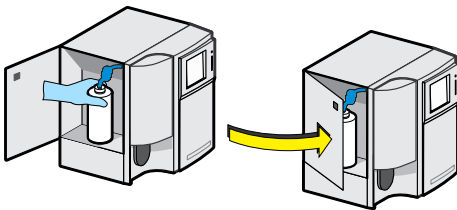

# B

## REPLACE/ADJUST PROCEDURES REPLACING REAGENTS

### Replace the A<sup>C</sup>•T Tainer

Look at step 2. If your reagent container is like the picture, use the instructions on this page. Otherwise, use the instructions in the Replace the A<sup>C</sup>•T Pak Heading.



- 1** Check the reagent container to see if it is empty. If the container is not empty, touch the **reagent** icon to prime.



If the container is empty, continue to step 2 for reagent replacement.



**2**

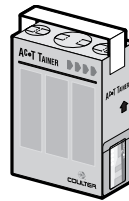
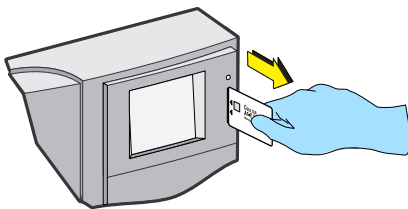

**3**

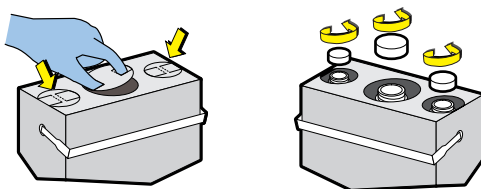

**4**

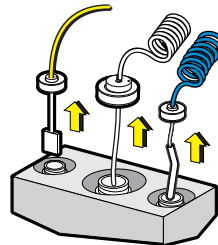
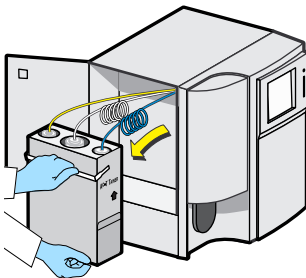

5

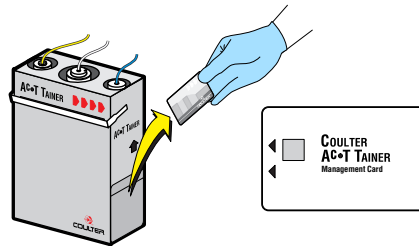
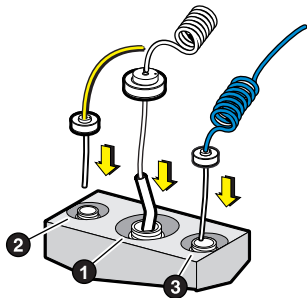

6

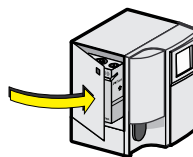
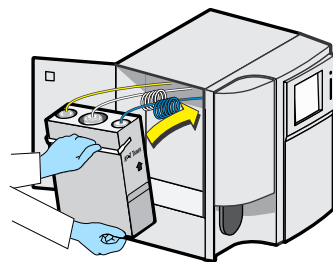

7

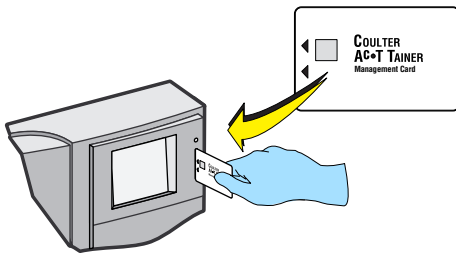

8

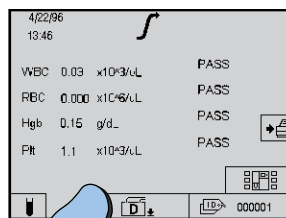
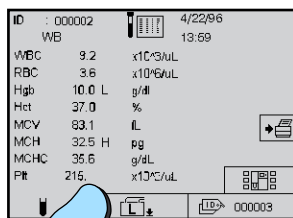

9 Record the reagent lot number and expiration date from the new A<sup>C</sup>•T Tainer into your laboratory's logbook.

# A

## REPLACE/ADJUST PROCEDURES REPLACING THE WASTE CONTAINER

### 2.2 REPLACING THE WASTE CONTAINER

Replace the waste container when you see:

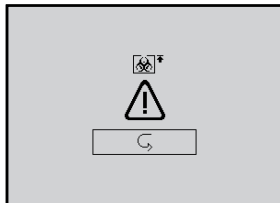

---

**WARNING** Waste can include biohazardous material that could cause contamination. Handle and dispose of according to acceptable laboratory standards.

---

**1**

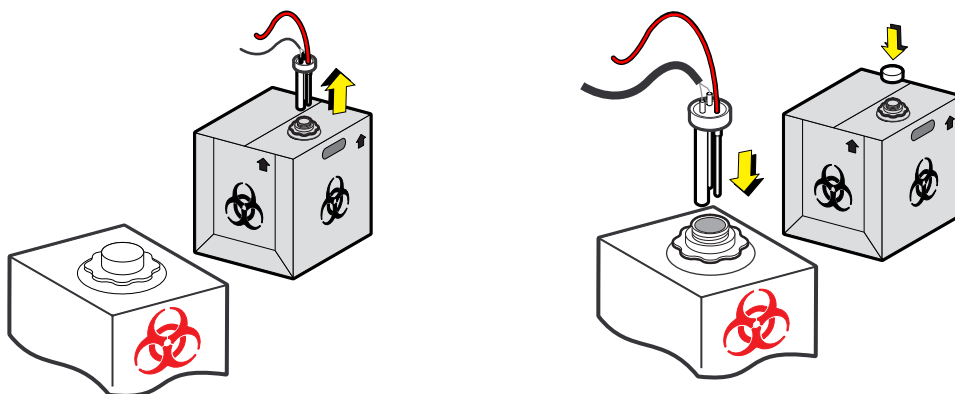

**2**

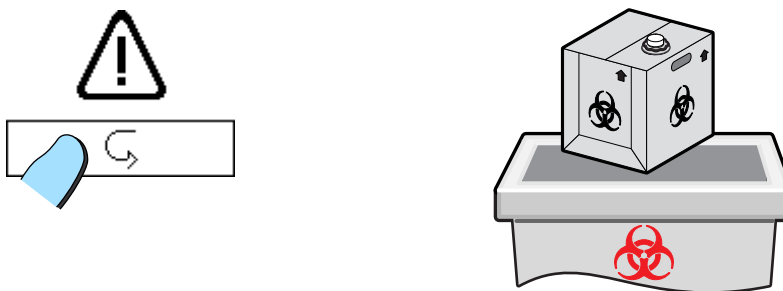

## 2.3 REPLACING DILUENT FILTERS

To optimize instrument performance, replace the diluent filters every 12,000 cycles at the same time you replace the peristaltic pump tubing.

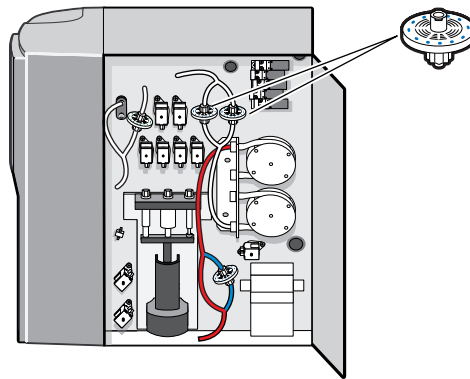

Note: If the vacuum fluid barrier filter becomes plugged, replace it with the following method.

---

**WARNING** Possible injury to hands. The peristaltic pumps rotate at various intervals during a normal run. To avoid injury, do not put your hands in the area while the instrument is cycling.

---

**1**

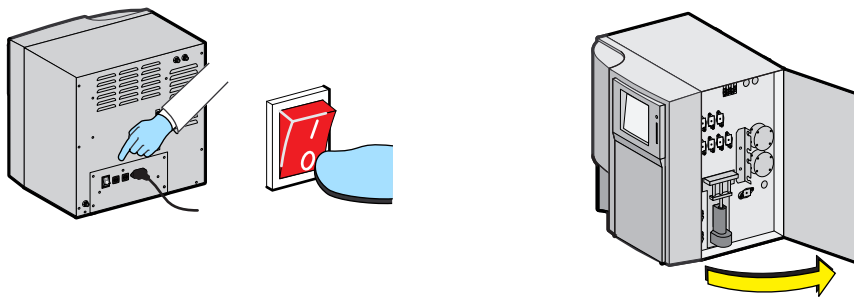

**REPLACE/ADJUST PROCEDURES**  
*REPLACING DILUENT FILTERS*

**2**

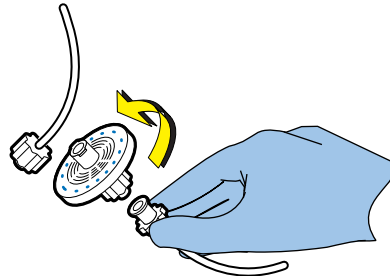
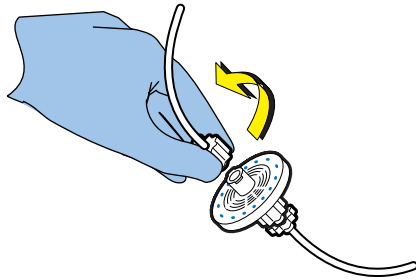

**3**

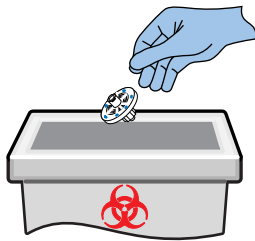

**4**

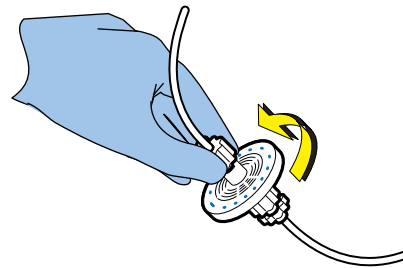
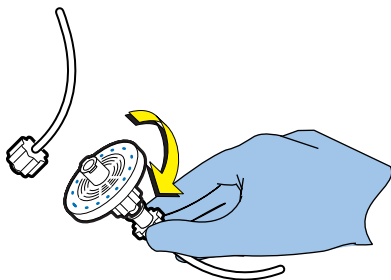

**5**

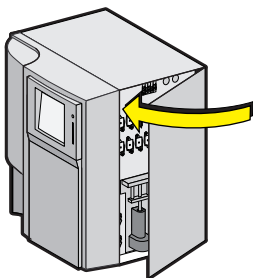

**6** Cycle a sample with known results to verify instrument performance.

## 2.4 REPLACING PERISTALTIC PUMP TUBING

To optimize instrument performance, replace the peristaltic pump tubing every 12,000 cycles. At the same time, replace the diluent filters (see Heading 2.3). Also, check periodically for defects or twists in the tubing or for pump rollers that are not rotating properly as these things may cause the tubing to wear more quickly.

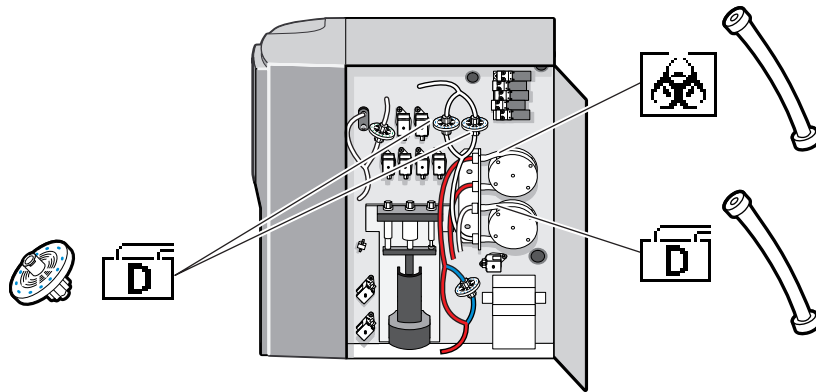

---

**WARNING** Possible injury to hands. The peristaltic pumps rotate at various intervals during a normal run. To avoid injury, do not put your hands in the area while the instrument is cycling.

---

1

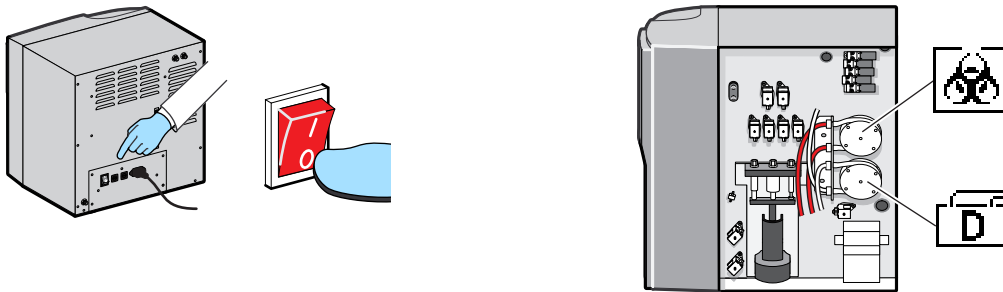

---

**WARNING** The waste pump tubing can contain biohazardous material that can cause contamination if not handled properly. Handle these components according to acceptable laboratory practices.

---

**REPLACE/ADJUST PROCEDURES**  
*REPLACING PERISTALTIC PUMP TUBING*

**2**

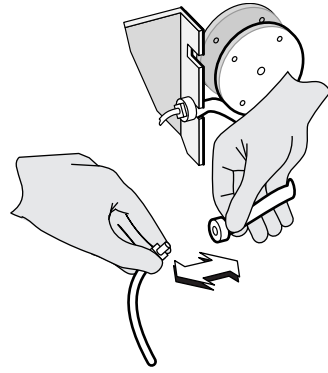
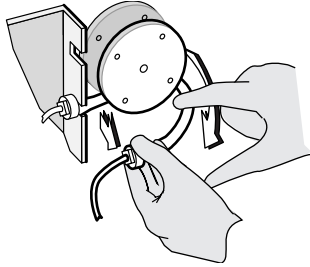

**3**

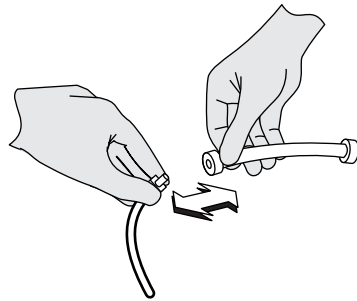
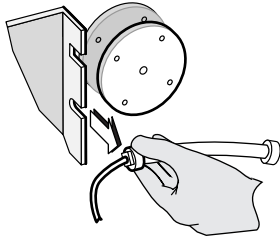

**4**

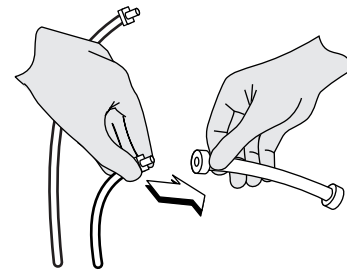



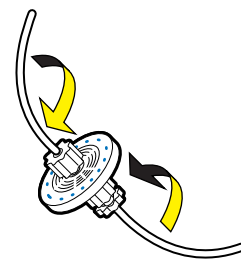
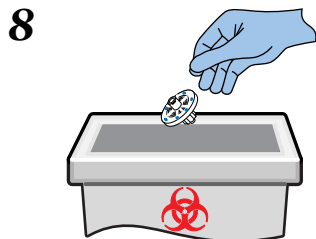
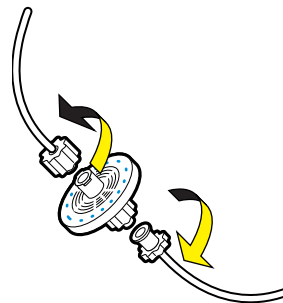
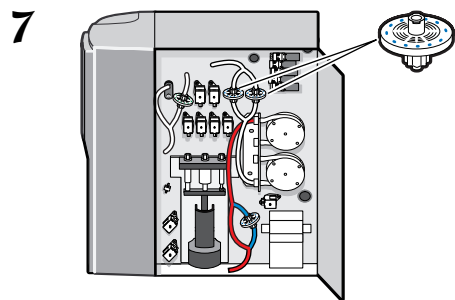
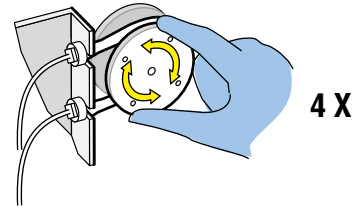
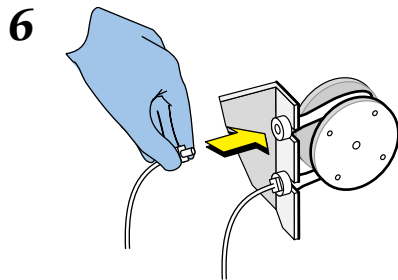
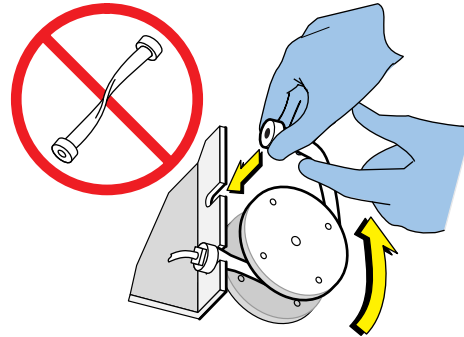
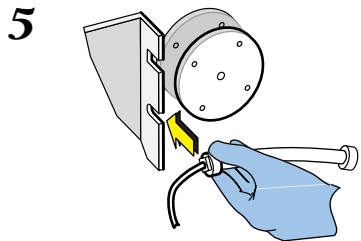

**REPLACE/ADJUST PROCEDURES**  
*REPLACING PERISTALTIC PUMP TUBING*

**9**

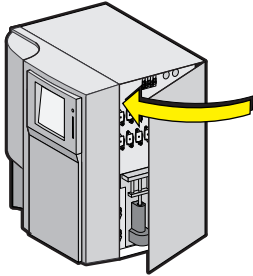

**10** You must prime the diluent lines.

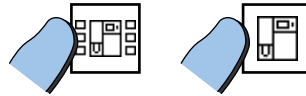

**11**

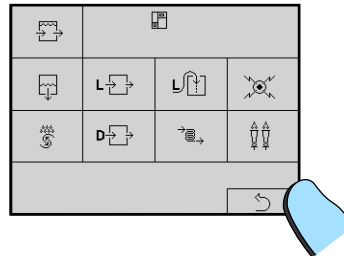
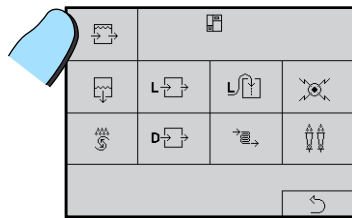

**12** Cycle a sample with known results to verify instrument performance.

## 2.5 REPLACING CHECK VALVES



Check valves allow liquid or air to flow through in one direction only.

Replace a check valve if:

- It is clogged.
- It lets liquid or air flow both ways.

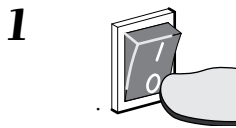

- 2** Record direction in which check valve is pointing before you remove it.

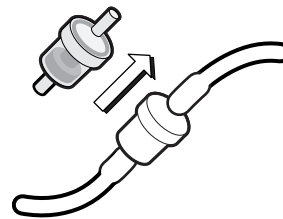

---

**WARNING** Biohazardous material might be contained in the check valves and associated tubing and could cause contamination unless handled with care. Wear protective gear. Avoid skin contact. Clean up spills immediately. Dispose of valve and tubing according to acceptable laboratory procedures.

---

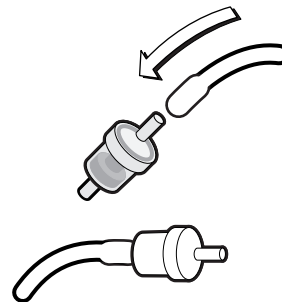
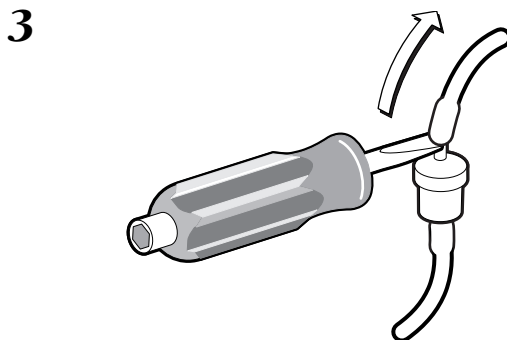

**REPLACE/ADJUST PROCEDURES**  
*REPLACING CHECK VALVES*

**4**

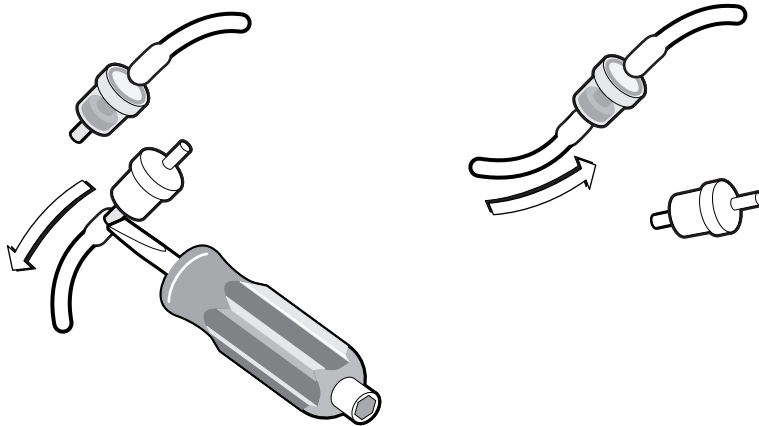

---

**IMPORTANT** To avoid obtaining misleading results, make sure the new valve is in the same position as the old one.

---

**5**

Discard old check valve in biohazardous waste container.

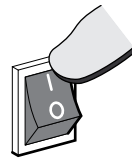

**6**

Cycle a sample with known results to verify instrument performance. Watch the sample and ensure that the check valve is working properly and does not leak.

## 2.6 REPLACING TUBING

Replace tubing if it is cracked, leaking or has lost resilience.



1

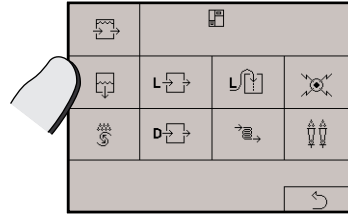
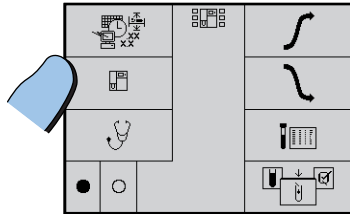

2

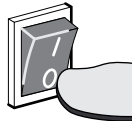

3

Remove the tubing section from the two components it connects.

Measure new tubing of the same material, color code and bore size of the old tubing you just removed. Cut the tubing with scissors.

4

Push new tubing onto the two components it is to connect.

5

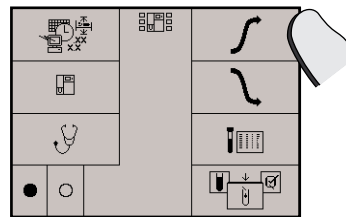

6

Run a sample with known results to verify instrument performance. Make sure that the new tubing is correctly connected and does not leak.

**REPLACE/ADJUST PROCEDURES**  
*REPLACING FUSES*

## 2.7 REPLACING FUSES

Replace fuses as needed.

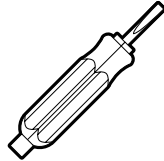

1.5 Amp  
Slo Blo  
250V

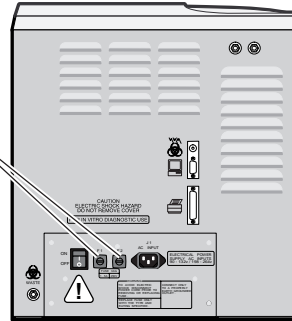

**1**

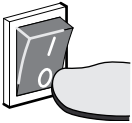

**2**

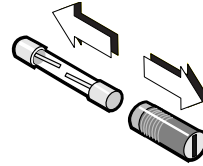
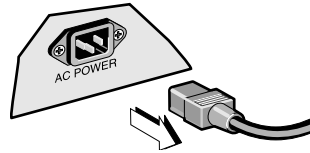
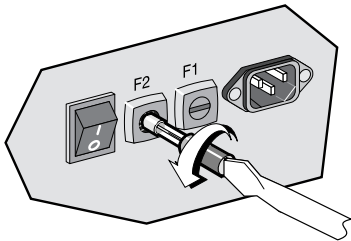

**3**

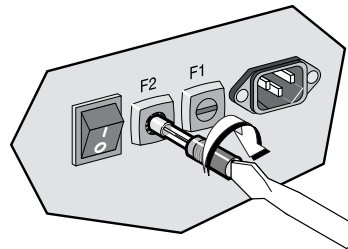
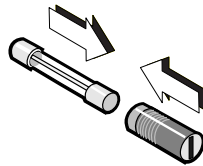

**4**

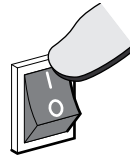
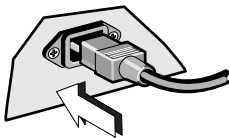

## 2.8 REPLACING VACUUM ISOLATOR CHAMBER

Replace the Vacuum Isolator Chamber (VIC) when it is defective. See Table 1-1 for defective situations.

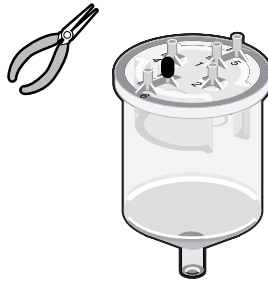

1

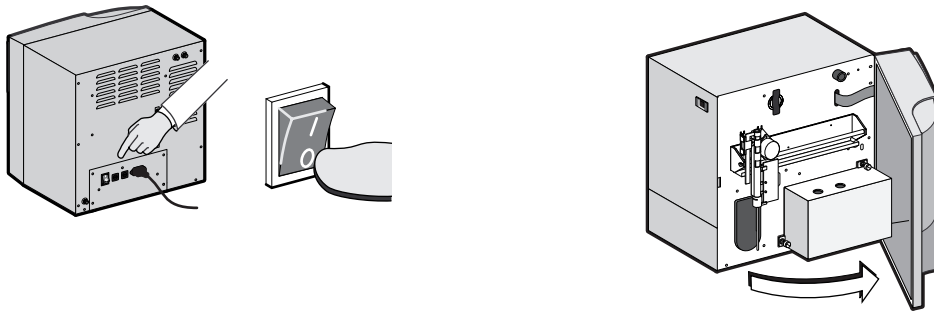

---

**WARNING** The waste pump tubing can contain biohazardous material that could cause contamination if not handled properly. Handle these components according to acceptable laboratory practices.

---

2

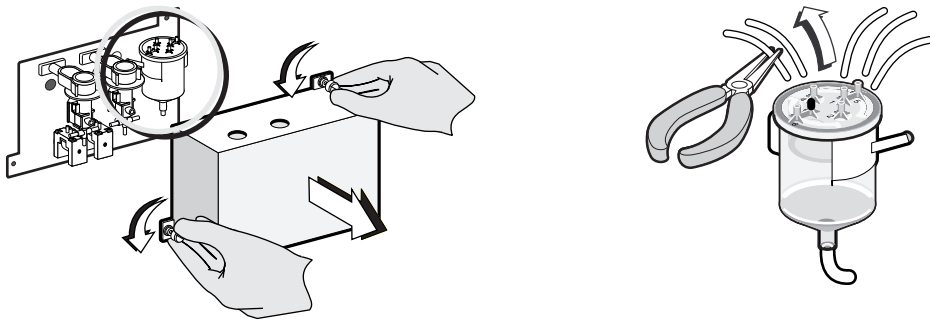

**REPLACE/ADJUST PROCEDURES**  
*REPLACING VACUUM ISOLATOR CHAMBER*

- 3** Note: If tubing to the Vacuum Isolator Chamber is worn or cracked, replace it with new tubing from your accessory kit.

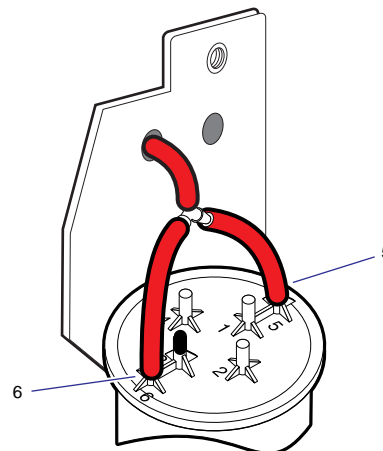
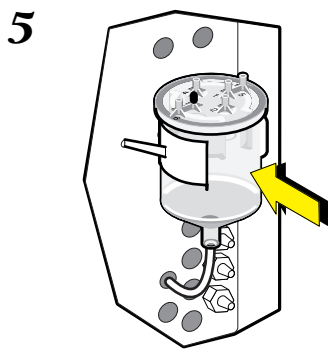
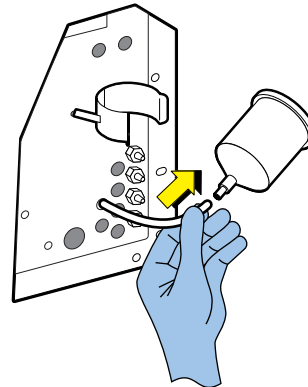
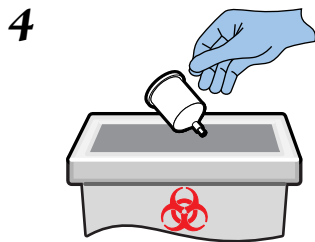
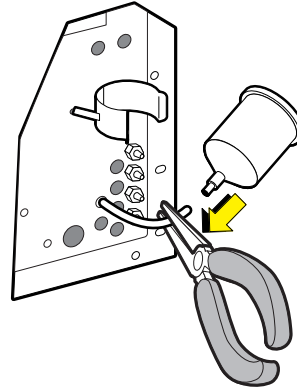
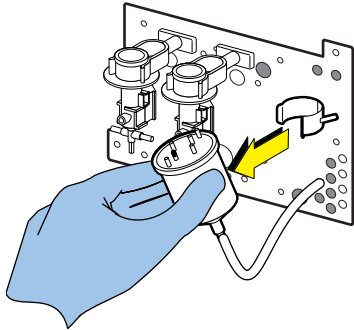



6

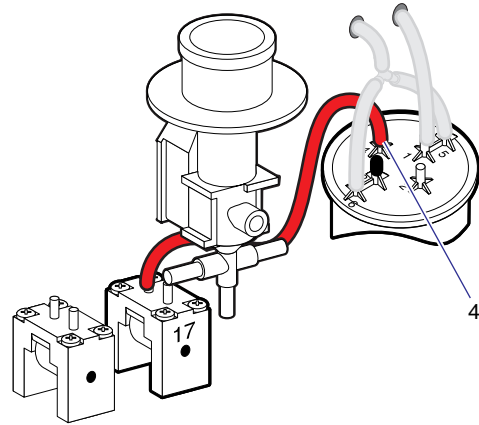
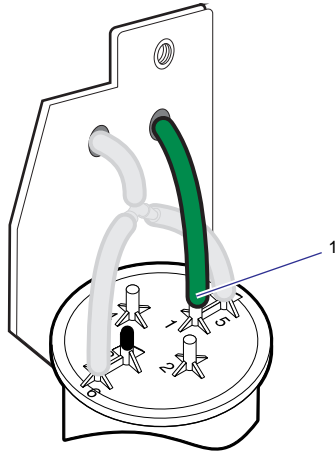

7

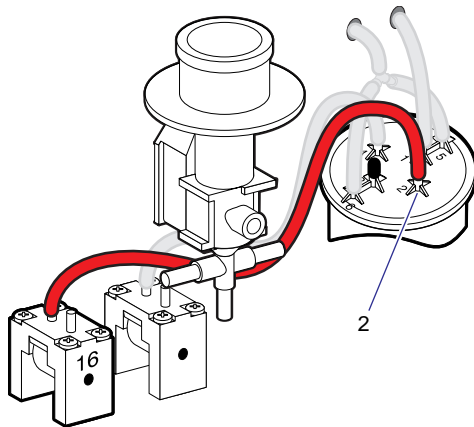

8

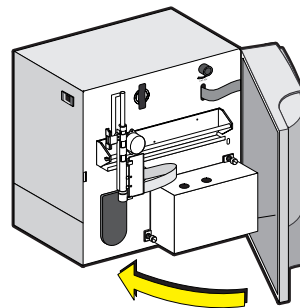
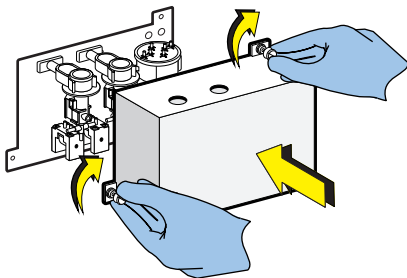

**REPLACE/ADJUST PROCEDURES**  
**REPLACING VACUUM ISOLATOR CHAMBER**

**9**

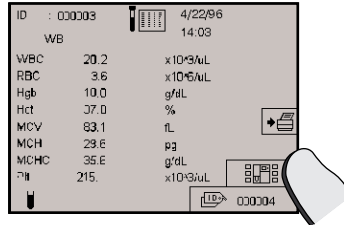
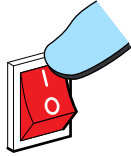

**10**

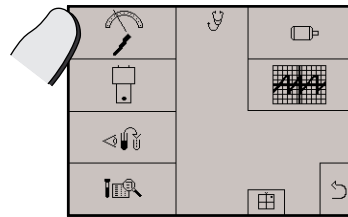
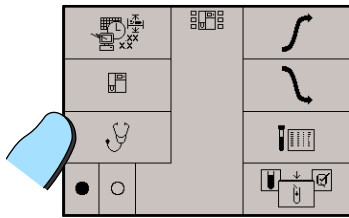

**11**

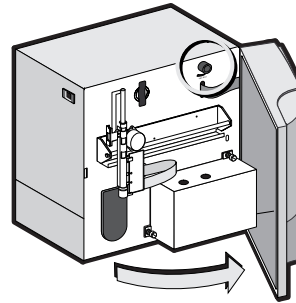
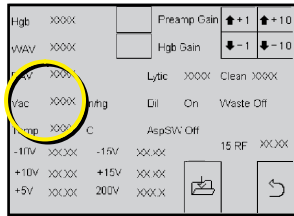

**12**

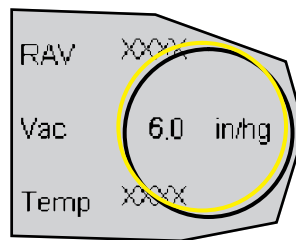
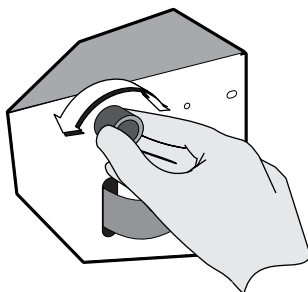

**B**

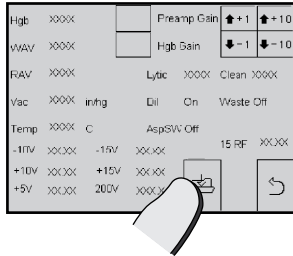

**14** Cycle a sample with known results to verify instrument's performance.

**REPLACE/ADJUST PROCEDURES**  
*REPLACING SYRINGE PISTONS AND SEALS*

## 2.9 REPLACING SYRINGE PISTONS AND SEALS



To optimize instrument performance, replace the syringe pistons and seals every 12,000 cycles. When replacing more than one syringe piston, be sure to replace them one at-a-time to ensure that you do not misplace the plungers. (See Heading 1.1 for how to determine the cycle count.)

Also check periodically to see if large amounts of liquid are leaking behind the syringe plunger. If there are, perform a reproducibility test (see Heading 1.4).

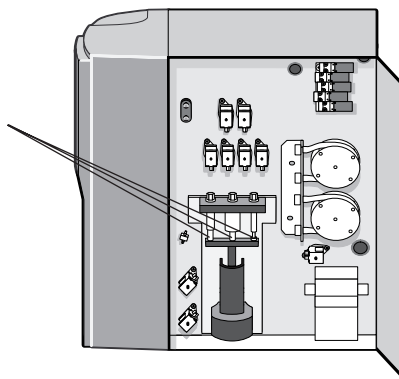
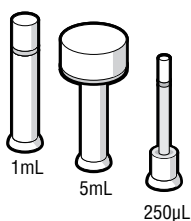

**1**

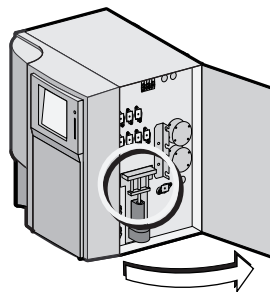
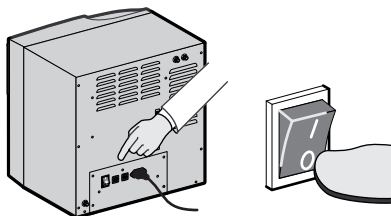

2

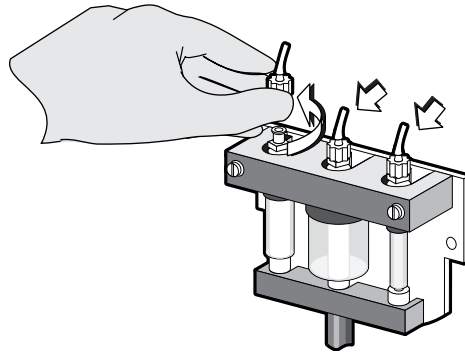
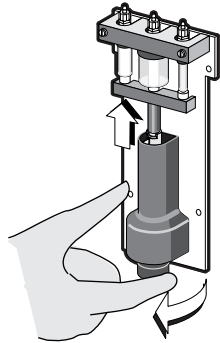

3

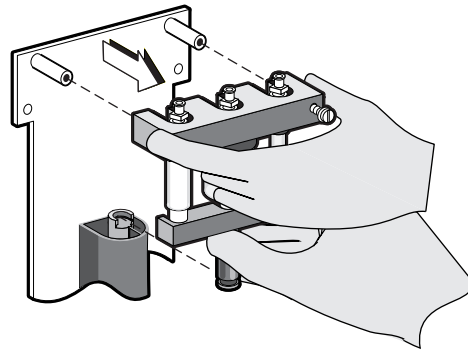
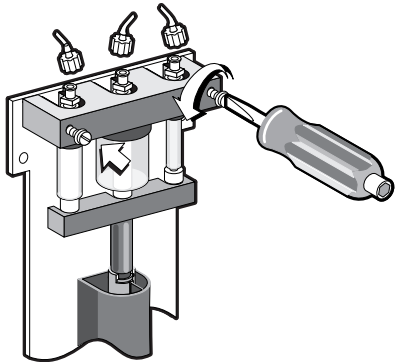

4

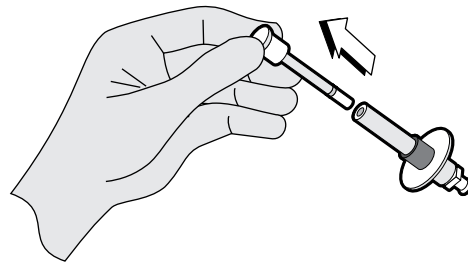
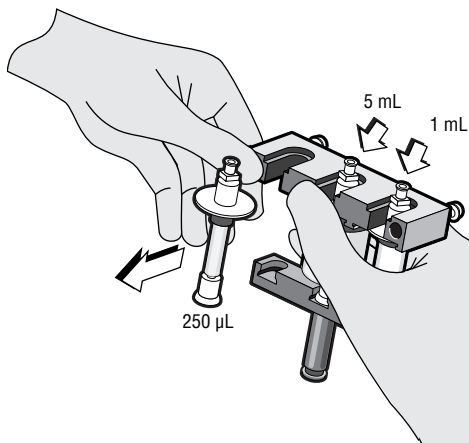

**REPLACE/ADJUST PROCEDURES**  
*REPLACING SYRINGE PISTONS AND SEALS*

5

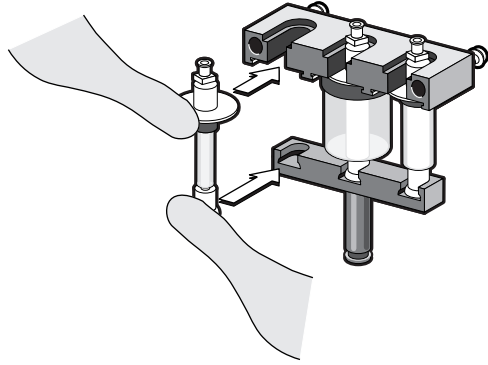
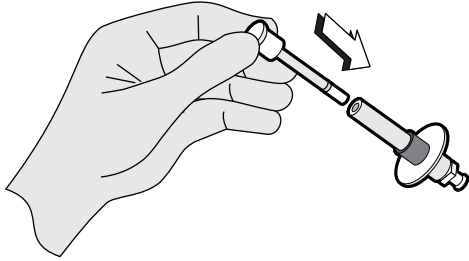

6



7

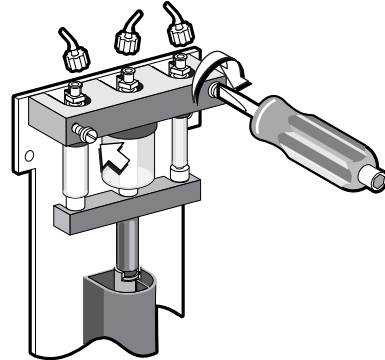
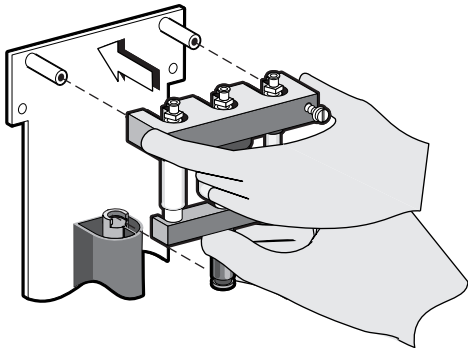

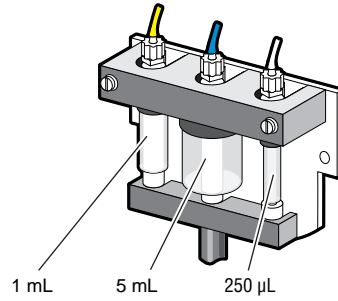
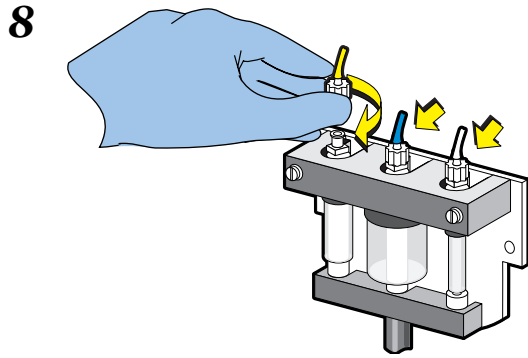

Note: Be sure to tighten tops firmly.

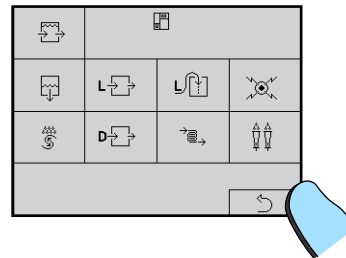
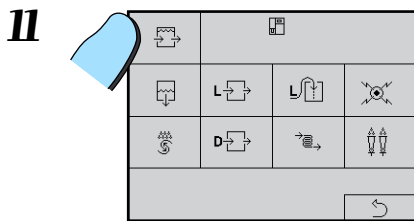
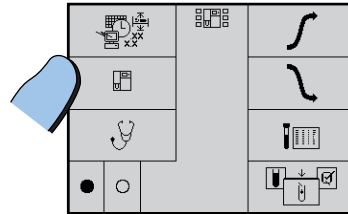
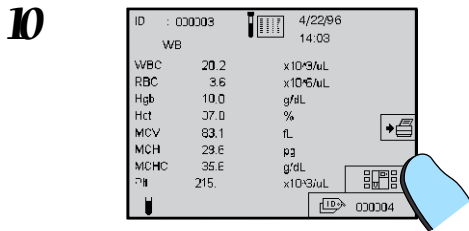
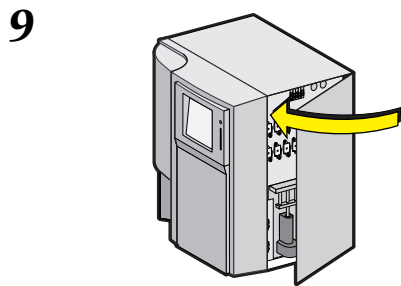

**12** Cycle a sample with known results to verify instrument's performance.

**REPLACE/ADJUST PROCEDURES**  
*REPLACING THE PROBE WIPE*

## 2.10 REPLACING THE PROBE WIPE

Replace the probe wipe when it is defective or plugged. If fluid drips from the probe wipe but vacuum is good and the instrument works, then the probe wipe is probably defective and you should replace it.

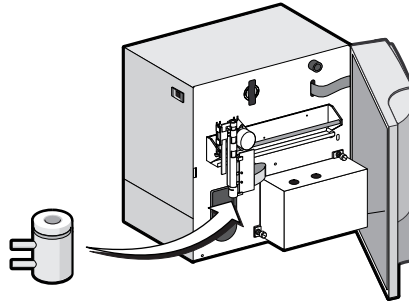

**1**

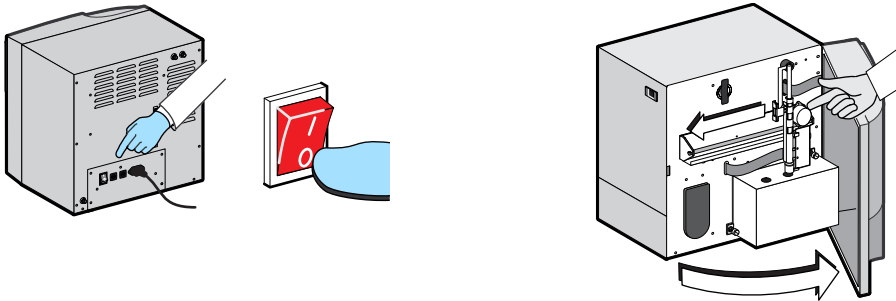

**2**

---

**WARNING** To avoid being exposed to biohazardous material, adhere to standard laboratory safety procedures.

---

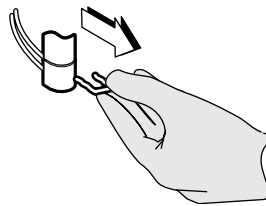
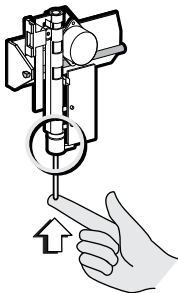



3

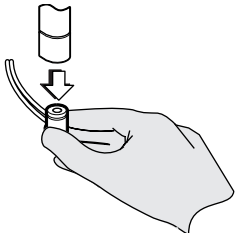
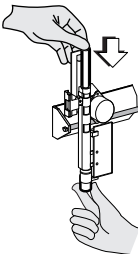

4

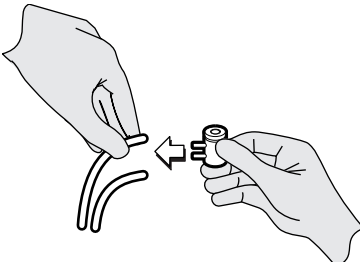

5

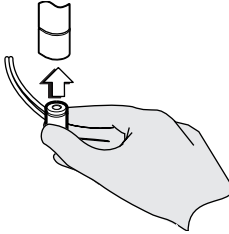
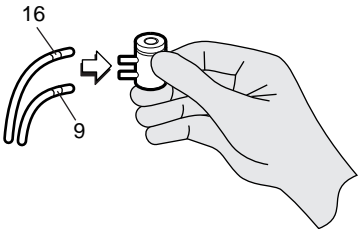

6

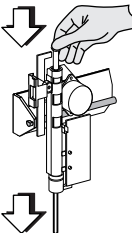
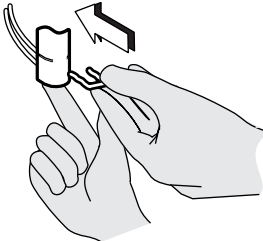

**REPLACE/ADJUST PROCEDURES**  
*REPLACING THE PROBE WIPE*

**7**

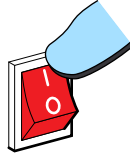
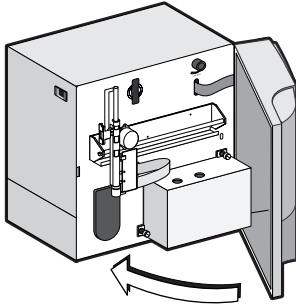

**8** Cycle a sample with known results to verify instrument's performance.

## 2.11 PREPARING TO SHIP THE INSTRUMENT



When you have done all the troubleshooting and you still cannot fix the problem, call your Coulter Representative. If directed to, follow the authorization procedures and prepare the instrument for shipment as follows.

1

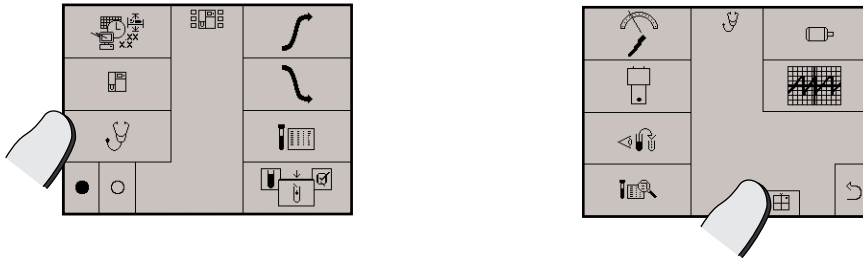

2

**WARNING** Instrument tubing can contain biohazardous material that can cause contamination if not handled properly. Handle these components according to acceptable laboratory practices.

Remove the diluent and lytic reagent pickup tubes from the reagent containers.

Remove the A<sup>C</sup>•T Rinse pickup tubes from the rinse container.

3

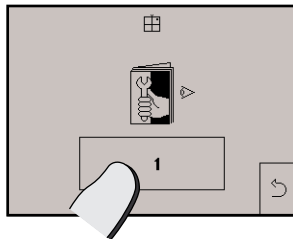

This process takes approximately 2 minutes.

4

Place the diluent and lytic reagent tubes upright in a deep container filled with distilled water.

Place the rinse tube upright in a deep container filled with a 50% bleach-50% distilled water solution.

**REPLACE/ADJUST PROCEDURES**  
*PREPARING TO SHIP THE INSTRUMENT*

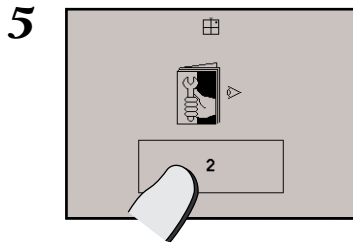

This process takes approximately 2 minutes.

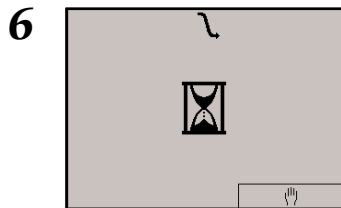

Remove the A<sup>C</sup>•T Rinse pickup tube from the bleach and place it with the others in distilled water. The shutdown procedure is 15 minutes long.

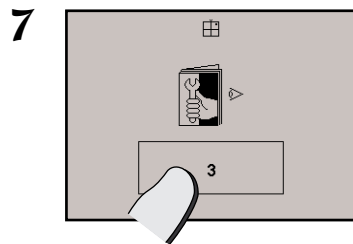

This process takes approximately 1 minute.

**8** Remove the tubes from their respective solutions and place them on paper to dry.

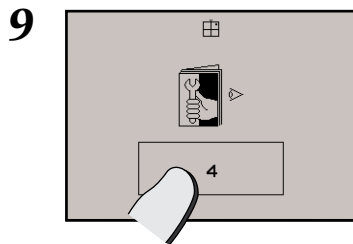

This process takes approximately 4 minutes, 15 seconds.

- I** Ready to ship screen appears. The instrument is cleaned out and decontaminated.

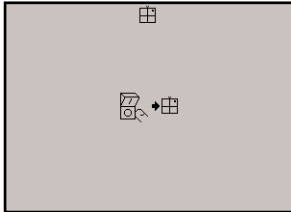

- II** Remove the waste tubes and sensor from the waste container. Squirt the waste tubes with a bleach solution to decontaminate.

Disconnect the reagent and rinse pickup tubes from the instrument and pack them with the instrument.

Tightly seal all reagent containers. Remove reagent management card from instrument and put back into the card slot on the reagent container box.

- II** Disconnect all cables (power, printer) from the instrument. Pack them with the instrument.

- B** Pack the instrument in its original box. Ship the instrument to the address obtained from your Coulter Representative.

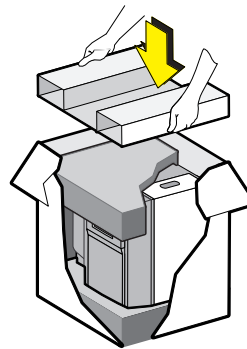



**REPLACE/ADJUST PROCEDURES**  
*PREPARING TO SHIP THE INSTRUMENT*

### 3.1 TROUBLESHOOTING TOOLS

Knowing what your A<sup>C</sup>•T analyzer does, how it sounds when operating properly, and what normal results look like are the keys to troubleshooting problems. Study the Normal Sample Flow (see Reference manual, Heading 3.2). Then watch and listen while the instrument goes through its cycles.

If you later find that your A<sup>C</sup>•T analyzer is not operating properly, you can begin to isolate the problem by studying irregular results (Table 3-9) and watching the instrument cycle a sample.

## Diluter Functions

The Diluter Functions screen provides you with basic diluter functions to use in troubleshooting. Table 3-1 describes the diluter functions.

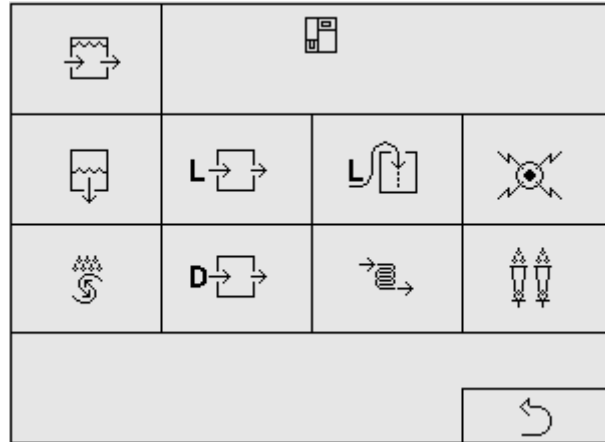
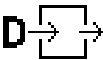







**Table 3.1 Diluter Functions Screen**

Icon	Description	Function
	Wet Prime	<ul style="list-style-type: none"> <li>Primes the diluent fluidic path and baths.</li> <li>Dispenses lytic reagent to WBC bath.</li> <li>Removes air from diluent and lytic reagent lines.</li> </ul>
	Sweepflow	Primes the fluidic path from the diluent reservoir through the sweepflow coil and the path between the RBC aperture and the vacuum isolator chamber.
	Automatically drains the baths then, after you aspirate bleach, cleans the baths.	<ul style="list-style-type: none"> <li>Cleans the baths with a solution other than COULTER A<sup>C</sup>•T Rinse cleaning agent (see Heading 1.4). If the zap aperture function does not work, this is the third attempt (after Shutdown) to clear a clogged aperture.</li> </ul>
	Primes the lytic reagent system when the A <sup>C</sup> •T is first installed or reinstalled after being drained.	Primes the lytic reagent path of the fluidics system. Fills the lytic reagent path completely even if it is empty.

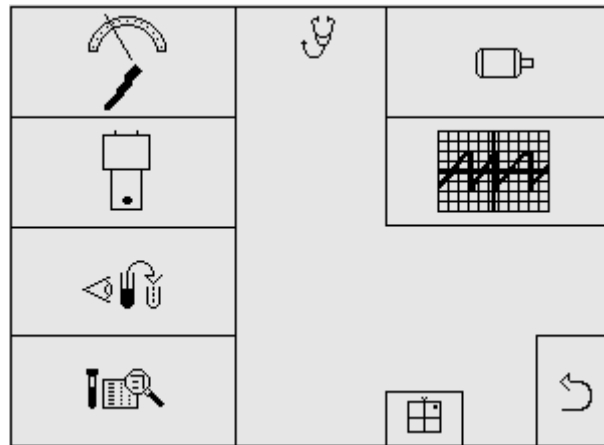

**Table 3.1 Diluter Functions Screen (Continued)**

Icon	Description	Function
	Primes the diluent system.	Primes pickup tube and diluent reservoir. Fills the diluent path (between the diluent container and the diluent reservoir) completely, even if it is empty.
	Drains the baths and the vacuum isolator chamber.	<ul style="list-style-type: none"> <li>■ Drains fluid before you remove the baths or the vacuum isolator chamber.</li> <li>■ Verifies the operation of the waste pump.</li> </ul>
	Primes the diluent reservoir system and fills both baths with fresh diluent.	<ul style="list-style-type: none"> <li>■ Verifies operation of the rinse pump.</li> <li>■ Helps detect a plugged filter.</li> <li>■ Checks the operation of the diluent pump if you use it enough times to force a refill of the reservoir.</li> </ul>
	Sends mixing bubbles to each bath in turn.	<ul style="list-style-type: none"> <li>■ Verifies operation of air/mix system.</li> <li>■ Helps detect plugs or leaks in the fluid barrier.</li> </ul>
	Performs an aperture burn or zap.	Attempts to clear a plugged aperture, perform several times.
	Dispenses lytic reagent into the WBC bath.	<ul style="list-style-type: none"> <li>■ Manually primes the lytic reagent system.</li> <li>■ Checks for bubbles in the lytic reagent system.</li> <li>■ Verifies the operation of the lytic reagent pump.</li> </ul>
	Exits from the Diluter Functions screen.	Returns to previous screen.

## Diagnostic Functions

The Diagnostic Functions screen provides you with basic diagnostic functions to use in troubleshooting. Table 3-2 describes the diagnostic functions.



**Table 3.2 Diagnostic Functions Screen**







Icon	Description	Function
	Displays current state of digital sensors and current value of analog sensors and voltages.	<ul style="list-style-type: none"> <li>■ Lets you adjust to 6.00 vacuum.</li> <li>■ Lets you verify correct sensor readings.</li> </ul>
	Displays solenoids screen and allows you to change the state (ON or OFF) of each solenoid.	Lets you test solenoid functions.
	Displays verify predilute screen.	Lets you verify that the instrument is dispensing 1580 $\mu$ L of diluent.

Table 3.2 Diagnostic Functions Screen (Continued)

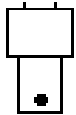
Icon	Description	Function
	Displays details of the last sample run screen.	Lets you troubleshoot aperture problems.
	Displays motors screen and allows you to interactively run each motor through its normal range of motion.	<b>CAUTION</b> Indiscriminate use of these functions can damage the instrument. Do not use the motors function without instruction from your Coulter Representative.
	Displays an in-progress screen and performs an electronics pulse test.	Lets you verify the electronic stability of the instrument for WBC and RBC apertures.
	Prepare the instrument for shipping.	Lets you drain and disinfect the instrument in preparation for shipping.
	Exits the Diagnostic Functions screen.	Returns to previous screen.

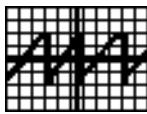

**TROUBLESHOOTING**  
*TROUBLESHOOTING TOOLS*

### 3.2 WHAT FLAGS MEAN

Table 3-3 describes the flags and suggests actions you should perform when they appear.

**Table 3.3 What Flags Mean**

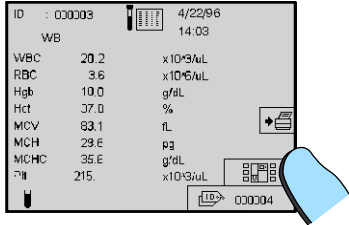
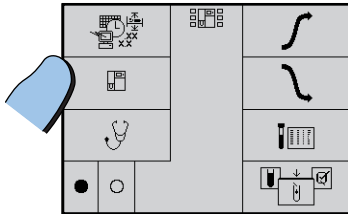
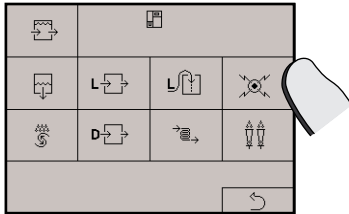
Flag	Means	Flag Description/Suggested Action
<p>----- (dashes)</p>	<p>Voteout</p>	<p><b>Description:</b> At least two of the three count periods did not agree.</p> <p><b>Suggested Action:</b></p> <ol style="list-style-type: none"> <li>1. Thoroughly mix and rerun the sample.</li> <li>2. If the voteout repeats, zap apertures:               <ol style="list-style-type: none"> <li>a.                    </li> <li>b.                    </li> <li>c.                    </li> </ol> </li> </ol>

**Table 3.3 What Flags Mean (Continued)**

Flag	Means	Flag Description/Suggested Action
<p>-----                      (dashes)</p>	<p>Voteout</p>	<p>d.</p>  <p>e.</p>  <ol style="list-style-type: none"> <li>6. Thoroughly mix and rerun the sample.</li> <li>7. If the voteout repeats, run a previously run sample with known values.</li> <li>8. If the voteout repeats, clean the baths according to Clean the Baths Heading.</li> <li>9. Thoroughly mix and rerun the sample.</li> <li>10. If the voteout repeats, call your Coulter Representative.</li> </ol>

Table 3.3 What Flags Mean (Continued)

Flag	Means	Flag Description/Suggested Action
+++++ (pluses)	Overrange	<b>Description:</b> Parameter result exceeds its operating limit.
WBC +++++	WBC>150.0	<b>Suggested Action:</b> Is the Hgb result +++++ or abnormally high? If no, ensure that the bath shield is in place. If yes, there may be leak in the lytic reagent system. Call your Coulter Representative. If no, make a dilution to determine the WBC: <ol style="list-style-type: none"> <li>Dilute 1 part thoroughly mixed sample with 1 part normal saline (0.85% NaCl) in a clean test tube.</li> <li>Mix then immediately run the dilution in whole blood mode.</li> <li>Multiply the WBC result by 2. Corrected WBC = (Dilution result x 2)</li> <li>Report corrected WBC.</li> </ol>
PLT +++++	PLT>3000.0	<b>Suggested Action:</b> <ol style="list-style-type: none"> <li>Make a dilution to determine the Plt count: Dilute 1 part thoroughly mixed sample with 1 part normal saline (0.85% NaCl) in a clean test tube.</li> <li>Mix then immediately run the dilution in whole blood mode.</li> <li>Multiply the Plt result by 2. Corrected Plt = (Dilution result x 2)</li> <li>Report corrected Plt.</li> </ol>
MCV +++++	MCV <50 fL or MCV >130 fL	<b>Suggested Action:</b> Call your Coulter Representative.
RBC +++++ Hgb +++++	RBC >8.00 Hgb >30.0	

**TROUBLESHOOTING**  
*WHAT FLAGS MEAN*

**Table 3.3 What Flags Mean (Continued)**

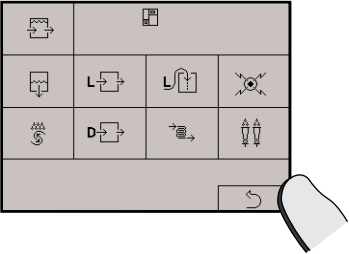
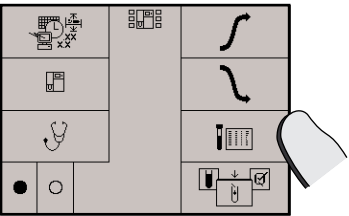
Flag	Means	Flag Description/Suggested Action
<b>+</b> (plus) <b>WBC+</b> <b>RBC+</b> <b>Hgb+</b> <b>Plt+</b>	Overrange >99.9 <150 >7.00 <8.00 >25.0 <30.0 >999 <3000	<b>Description:</b> Parameter results exceed linearity limits.  <b>Suggested Action:</b> Verify results according to your laboratory's protocol.
<b>*****</b> (asterisks)  <b>WBC*****</b> and/or <b>RBC*****</b> <b>Plt*****</b>  <b>MCV*****</b> <b>Hct*****</b> <b>MCH*****</b> <b>MCHC*****</b>	Aperture Alert	<b>Description:</b> The Aperture Alert noticed a problem that could compromise the integrity of the results.  <b>Suggested Action:</b> <ol style="list-style-type: none"> <li>1. Remove the stopper and gently mix the sample with a wooden applicator stick to check for fibrin strands or clots.                 If fibrin strands or clots are found, collect and run a new sample.                 If fibrin strands or clots are not found, thoroughly mix and rerun the sample.</li> <li>2. If the Aperture Alert repeats, run a previously run sample with known values.</li> <li>3. If the Aperture Alert repeats, zap apertures:               <ol style="list-style-type: none"> <li>a.                   <div data-bbox="824 1339 1166 1562" data-label="Image"> </div> </li> </ol> </li> </ol>

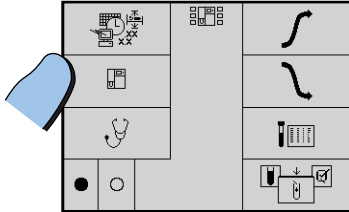
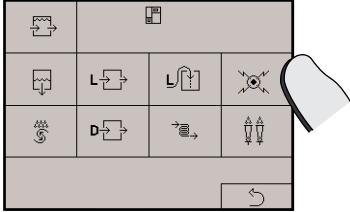
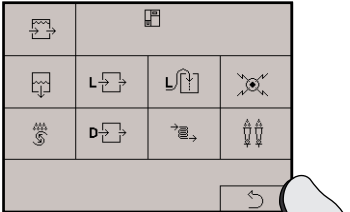
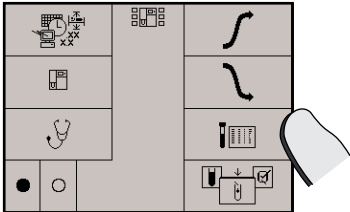

Table 3.3 What Flags Mean (Continued)

Flag	Means	Flag Description/Suggested Action
<p>***** (asterisks) continued</p>	<p>Aperture Alert</p>	<p>b. </p> <p>c. </p> <p>d. </p> <p>e. </p> <p>6. Thoroughly mix and rerun the sample. 7. If the Aperture Alert repeats, clean the baths according to the Clean Baths Heading.</p>

**TROUBLESHOOTING**  
**WHAT FLAGS MEAN**

**Table 3.3 What Flags Mean (Continued)**

<b>Flag</b>	<b>Means</b>	<b>Flag Description/Suggested Action</b>
***** (asterisks) continued	Aperture Alert	8. Thoroughly mix and rerun the sample. 9. If the Aperture Alert repeats, call your Coulter Representative.
..... (dots)  Hgb .....	Hgb Incomplete	<b>Description:</b> The Hgb Blank and/or Hgb Read results do not correlate.  <b>Suggested Action:</b> Thoroughly mix and rerun the sample. If Hgb ..... repeats, call your Coulter Representative.
..... Other parameters (not WBC/RBC/Hgb)     all parameters	Incomplete Computation	<b>Description:</b> System does not have enough information to compute a result.  <b>Suggested Action:</b> Is WBC, RBC, and/or LY% - - - - ‡? If yes, follow instructions for the - - - - (dashes) flag.  If no, <u>and</u> there is no Aperture Alert, verify sample handling:  If this sample has been refrigerated, warm to room temperature then thoroughly mix and rerun sample.  Some samples require a longer than normal equilibration time. Wait 10 to 15 minutes then thoroughly mix and rerun the sample.  If this sample is more than 5 hours old, collect a fresh sample.  Vacuum or Hgb voltage error.
<b>H</b>	High	Result is higher than your laboratory's reference range high action limit.
<b>L</b>	Low	Result is lower than your laboratory's reference range low action limit.

Table 3.3 What Flags Mean (Continued)

Flag	Means	Flag Description/Suggested Action
*	Review Results	<p><b>Description:</b> An * flag indicates a questionable result.</p> <p><b>Suggested Action:</b></p>
* WBC		Is WBC <1.0? If yes, follow your laboratory protocol for verification. If no, then thoroughly mix and rerun sample.
*WBC,LY%,LY#		Thoroughly mix and rerun sample.
*WBC,LY#		Follow your laboratory's protocol to review results.
*LY%,LY#		<p>One or more of the following conditions may be triggered. Follow your laboratory's protocol to review results.</p> <ol style="list-style-type: none"> <li>1. LY# &lt;1.2 or &gt;3.4</li> <li>2. Non-lymph number &lt;1.0 or &gt;7.0.</li> <li>3. LY/Non-lymph ratio &gt;1.0.</li> </ol>

# B

## TROUBLESHOOTING WHAT FLAGS MEAN





**Table 3.3 What Flags Mean (Continued)**

<b>Flag</b>	<b>Means</b>	<b>Flag Description/Suggested Action</b>
* RBC, Hgb, MCV, Hct, MCH, MCHC	Review Results	Is WBC is > linear range and/or operating range? If yes, follow instructions for <b>+</b> or <b>+++++</b> .
* MCV, Plt, Hct, MCH, MCHC		Is RBC > linear and/or operating range? If yes, follow instructions for <b>+</b> or <b>+++++</b> .
* MCH and MCHC		Is Hgb > linear and/or operating range? If yes, follow instructions for <b>+</b> or <b>+++++</b> .
* Hgb, Hct, MCH, MCHC		<ol style="list-style-type: none"> <li>Hgb/Hct ratio is out of limits.</li> <li>MCHC is &lt;25 or &gt;40.</li> </ol> <p>If yes, possible sample interference or instrument problem.</p>
* Plt		Plt fit process failed or the minimum Plt count criteria was not met or sweepflow problem was detected.
* RBC, Plt, Hgb, MCH, MCHC		Is MCV <50? If yes, follow instructions for <b>+++++</b> .
* Hct, MCHC		Is MCV >130? If yes, follow instructions for <b>+++++</b> .

### 3.3 WHAT WARNING MESSAGES MEAN

Table 3-4 describes the warning messages and suggested recovery action.

**Table 3.4 Warning Messages**

Warning	Description	Suggested Action
	<ul style="list-style-type: none"> <li>■ Printer is disconnected.</li> <li>■ Printer is not turned on.</li> <li>■ Printer is offline or out of paper.</li> </ul>	Turn printer on and touch <b>printer</b> icon on the Sample Results screen to print. If you have no printer, check to see that auto- print is turned off (transmission screen). See the <b>Getting Started</b> manual, Chapter 1, Customize Software, Set Autoprint.
	Transmission incomplete	Sample transmission to host failed. Touch the <b>transmission</b> icon on the Sample Results screen to retry the transmission. If transmission still fails, check communications cable to host and make sure that the host is online. If failure still occurs, power instrument off and then on. Note: You lose sample results when you power off the instrument.
	Vacuum failure	Go to voltage screen and try to adjust vacuum to 6.00. If it does not adjust: <ul style="list-style-type: none"> <li>■ Make sure the pump is ON.</li> <li>■ Is there a leak associated with the Vacuum Isolator Chamber and associated tubing? Check all green striped tubing, front and right side. Is tubing connected tightly? Are there leaks?</li> <li>■ Is fluid barrier filter plugged? If yes, replace fluid barrier and adjust vacuum.</li> </ul>
	Hgb voltage failure	Run a startup. Startup tries to adjust Hgb voltage. If it does not adjust: <ul style="list-style-type: none"> <li>■ Make sure Hgb lamp is ON.</li> <li>■ Check for spillage around Hgb components on WBC bath.</li> <li>■ Make sure there is no diluent leak. (The baths fill and there is no air in the large 5-mL diluent syringe). Proper fluid level must be in the WBC bath at all times.</li> </ul>
	Electronic failure	Plt channel overrange. <ul style="list-style-type: none"> <li>■ Check for proper sweepflow operation with no bubbles.</li> <li>■ Check for sources of electrical interference.</li> <li>■ Check to ensure that bath shield is on.</li> <li>■ Check to ensure that Vacuum Isolator Chamber is clean and dry where the count drops appear.</li> </ul>

## TROUBLESHOOTING

### WHAT WARNING MESSAGES MEAN

**Table 3.4 Warning Messages (Continued)**







Warning	Description	Suggested Action
	Time keeper failure	Reset the time and date. See <b>Getting Started</b> manual, Chapter 1, Installing the Instrument.
	Setup data corrupted.	Check the setup values against your records. Correct the values, if necessary, and save. (See <b>Getting Started</b> manual, Chapter 1, Customize Software.) Print setup values. Run sample.
	Check A <sup>C</sup> •T Reagent Management card	Make sure card is in reader correctly. If problem persists, it may be time for new reagent with a new card. If problem occurs with a new card, there could be a problem with the card, card reader, card reader connection, or card reader controller (which is part of the display assembly).
	Waste full	Replace Waste container (Heading 2.2). Touch the <b>continue</b> icon.
	Diluent empty	<ul style="list-style-type: none"> <li>■ If reagent container does not appear empty, try priming first.</li> <li>■ If there appears to be reagent, but it does not fill properly, check for proper position of pickup tube, air leaks in tubing from cube to reservoir, worn peristaltic pump tubing, or a partially plugged blue filter to the diluent peristaltic pump PM2.</li> <li>■ Also check for crimps or plugs in the tubing from the reagent pickup through the peristaltic tubing and filter, to the bottom of the reservoir. These could affect reservoir fill.</li> <li>■ If reservoir is overfilled, replace peristaltic pump tubing (Heading 2.4) and diluent filters (Heading 2.3).</li> </ul>

Table 3.4 Warning Messages (Continued)

Warning	Description	Suggested Action
	Lytic reagent empty	<ul style="list-style-type: none"> <li>■ If reagent container does not appear empty, try priming first.</li> <li>■ If there is lytic reagent in the lytic reagent container, make sure reagent pickup tubing is in fluid and that tubing and fittings are not leaking between reagent pickup and lytic reagent sensor. The lytic reagent sensor is located in the lytic reagent tubing.</li> </ul>
	A <sup>C</sup> •T Rinse Shutdown Diluent (cleaner) empty	<ul style="list-style-type: none"> <li>■ If the cleaner container does not appear empty, try priming first.</li> <li>■ If priming does not work, make sure there are no leaks in any blue stripe tubing, beginning at the cleaning reagent pickup.</li> <li>■ Check the blue filter associated with peristaltic pump PM1, the tubing to LV13 and the tubing connections to the cleaning agent fluid sensor FS3.</li> </ul>

### 3.4 FATAL ERRORS

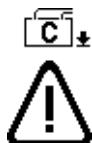

Turn OFF the instrument, then turn it ON to see if the error is corrected. Table 3-5 offers some suggested actions. If these do not solve the problem, call your Coulter Representative.

Table 3.5 Fatal Errors

 Number	Description	Probable Cause/Suggested Action
1	PCMCIA Error	Remove and reinstall software card. Turn the instrument ON. If problem still exists, obtain new software card.
3	DVM Error	There is an instrument power supply failure or the power to the instrument is out of range. A temporary loss of power can also trigger the error. Try turning the instrument OFF/ON. Ensure that the power supply to instrument and power source are good. Ensure that fuses are good. If turning the instrument OFF/ON does not work, call your Coulter Representative.
4	Unexpected Software Condition	If this occurs, reseal the software card and turn ON the power. If the problem still persists, obtain a new software card.

**TROUBLESHOOTING**  
**FATAL ERRORS**

**Table 3.5 Fatal Errors (Continued)**



 <b>Number</b>	<b>Description</b>	<b>Probable Cause/Suggested Action</b>
6	Probe Did Not Reach Up Position	The Probe has 3 horizontal and 3 vertical probe positions. When the probe is sent to, but does not reach, a position, an error is generated describing the position that was not reached.
7	Probe Did Not Reach Down Position	Turn the power OFF and move the probe vertically and horizontally. Make sure there is no binding and there is nothing in the mechanism path as it moves. Leave the probe in a central position horizontally and vertically.
8	Probe Did Not Reach Thief Position	Turn the power ON.
9	Probe Did Not Reach Aspirate Position	If the problem returns, check any probe movement that occurred. No attempt at movement indicates a motor or motor connection problem.
10	Probe Did Not Reach WBC Position	Erratic motion could indicate a motor problem or a mechanism problem.
11	Probe Did Not Reach RBC Position	Normal motion that seems to go into and past the proper position indicates a sensor or sensor connection problem.
12	Syringe Did Not Reach Up Position	The one syringe sensor is at the top of the syringe motion. At the beginning and during a cycle, the syringe is sent to the top position. If it does not get to the top, an error is generated. When the syringe is sent down, the sensor is checked. If the syringe is still in the top position, an error is generated.
13	Syringe Did Not Leave Up Position	If the syringe does not move at all, there is a motor problem, motor connection problem, or board problem. If the syringe moves erratically there may be a problem with the motor or the syringe mechanism: Binding or worn syringe pistons. Pistons pulled out of the syringe barrels.
14	Valve Error	Whenever you turn a solenoid (including the vacuum pump) on or off, a readback of the circuit is made. This readback indicates whether the valve is on or off. If the valve is off when it should be on, this error appears.



Table 3.5 Fatal Errors (Continued)

 <b>Number</b>	<b>Description</b>	<b>Probable Cause/Suggested Action</b>
<b>15</b>	Diluent Level Error During Power Up	During power up, the diluent reservoir is overfilled and drained enough to ensure that the sensor sees fluid and air. If both conditions cannot be sensed, this error is generated. Causes could be: Excess debris, bubbles, or buildup on the sensor.  Insufficient diluent because of: <ul style="list-style-type: none"> <li>■ low diluent supply</li> <li>■ leak in the diluent delivery system</li> <li>■ worn peristaltic pump tubing on the diluent pump</li> <li>■ plugged or partially plugged filter to the diluent pump.</li> </ul>
<b>16</b>	I <sup>2</sup> C Communication Failure	Each motor in the instrument has its own microprocessor to control it. Communication between the main processor and the motor processors uses a protocol called I <sup>2</sup> C. When problems occur with this communication process, this error is generated. All the components in question are found on the Analyzer card. If turning the power OFF/ON does not solve this problem, call your Coulter Representative.
<b>17</b>	Steps Missing	During a normal cycle, the syringe makes many up and down movements before getting back to the top position. All the up movements and down movements are tracked. When the syringe returns to the sensor position, the amount of up movement should equal the amount of down movement or this error is generated.
	Insufficient vacuum at beginning of cycle.	Leak or plug in vacuum system or problem with vacuum pump. Ensure that the vacuum pump is ON. Check the vacuum isolator system for leaks, plugs or fluid buildup.  Ensure that there are no plugs near the vacuum source, such as a plug in the fluid barrier (green striped).  Other problems may be with the pneumatic solenoids or vacuum sensor.



**TROUBLESHOOTING**  
*FATAL ERRORS*

### 3.5 TROUBLESHOOTING GUIDES

Tables 3-6 through 3-9 are troubleshooting guides. Each table details problems/situations, states the probable causes, and suggests actions for solving the situations.

**Table 3.6 Power Problems**

Situation	Probable Cause	Suggested Action
Screen is dark  Power LED is lit.	AC•T dims the screen if you do not use the instrument for 15 minutes and also requires a prime if you do not use it for 2 hours.	Touch the screen to brighten it. If the <b>continue</b> icon appears in the status field, touch it to prime the system.
Power will not turn on.	Power cord loose or not securely connected to wall or instrument.  Turn power OFF.  No voltage or wrong voltage at laboratory power outlet.  Defective power switch.  Instrument malfunction.	Make sure power cord is securely connected to instrument and wall.  Turn power ON.  Make sure voltage is on and outlet is 90-264 Vac. Check fuses, replace if necessary.  Call your Coulter Representative.  Call your Coulter Representative.



**TROUBLESHOOTING**  
*TROUBLESHOOTING GUIDES*

**Table 3.7 Aspiration Problems**

<b>Situation</b>	<b>Probable Cause</b>	<b>Suggested Action</b>
No aspiration takes place	<ol style="list-style-type: none"> <li>1. Tubing Problem. Plug or leak in tubing from aspirate probe to aspirate syringe.</li> <li>2. Problem with connection to syringe module.</li> <li>3. Problem with LV11. This valve is in the aspiration path and a plug or incorrect position would stop aspiration.</li> </ol>	<ol style="list-style-type: none"> <li>1. Inspect tubing for leaks, kinks or plugs. Also inspect tubing to LV11 and LV12. See Heading 2.5.</li> <li>2. Check to see that the connector on top of the 250 µL syringe module is tight and there is no air in the tubing or syringe. See Heading 2.8.</li> <li>3. The small brown knob on top of the solenoid valves will move when the valve energizes. Check that this moves during a cycle.</li> </ol>
incomplete aspiration.	It is very difficult to tell an incomplete aspiration when you are aspirating only 12 µL. This conclusion can only be arrived at by analyzing the results. WBC, RBC, Hgb and Plt would have to be low, with MCV normal.	Check for the same problems as above. They will be partial leaks or plugs instead of pulled-off tubes or total plugs. Also, LV12 may “steal” some of the aspirate volume if it does not completely block its connection to the syringe during aspiration.
Sample drips from probe after aspiration.	<ol style="list-style-type: none"> <li>1. Fluid drips from inside the probe.</li> <li>2. Fluid drips outside the probe.</li> </ol>	<ol style="list-style-type: none"> <li>1. This is a leak in the aspiration pathway. Check the same tubing and components as above for leaks.</li> <li>2. The probe wipe is not working. Check for leaks in the tubing to the probe wipe, a plug in the lower waste port of the probe wipe, a plug in the tubing between the lower probe wipe port and the Vacuum Isolator Chamber, a vacuum leak at the Vacuum Isolator Chamber, or no vacuum. Check to ensure that the vacuum pump is turned on and is working. (Vacuum pump is under left side door.)</li> </ol>

**Table 3.7 Aspiration Problems (Continued)**

<b>Situation</b>	<b>Probable Cause</b>	<b>Suggested Action</b>
bubbles in aspirator tubing between tip and aspirator pump.	<ol style="list-style-type: none"> <li>1. Leak from syringe to aspirate tip.</li> <li>2. Leak between diluent reservoir and syringe assembly.</li> </ol>	<ol style="list-style-type: none"> <li>1. If air is in these lines, check the components and tubing for partial or no aspiration.</li> <li>2. A leak from the reservoir to the syringe assembly will cause air to be in the aspirate and diluent syringe and in the line to the aspirate probe. This would involve the tubing, LV11 and LV12. Also check for leaks at the diluent or aspirate syringe.</li> </ol>

**Table 3.8 Background Problems**

<b>Situation</b>	<b>Probable Cause</b>	<b>Suggested Action</b>
<p>WBC, RBC and Plt exceed limits. Hgb may also be high in noted instances.</p>	<ol style="list-style-type: none"> <li data-bbox="553 527 915 758">1. Contaminated diluent.</li> <li data-bbox="553 758 915 926">2. Contaminated baths. This can be caused by a cleaning solution left in the baths for an extended period of time.</li> <li data-bbox="553 926 915 1220">3. Many bubbles in both baths. If not enough bubbles are dissipated by the end of the WBC count, they could affect the light path and give a high Hgb result.</li> <li data-bbox="553 1220 915 1524">4. Blood in the aspiration path before the background aspiration. The instrument guards against this and any problem that circumvents the system would usually cause some other error on the previous cycle.</li> </ol>	<ol style="list-style-type: none"> <li data-bbox="938 527 1372 758">1. Replace diluent. Do a prime and startup. If you suspect biological contamination, perform the Prepare to Ship procedure, Heading 2.11. This allows you to cycle bleach through all appropriate tubing and components.</li> <li data-bbox="938 758 1372 863">2. Run several startups to remove any contamination. Perform a Clean the Baths procedure (see Heading 1.3).</li> <li data-bbox="938 863 1372 1220">3. Check the system for bubbles, starting with the fluid reservoir and moving on to the syringe assembly. Remove the bath shield and run a cycle, observing the fluid in the baths if necessary. Repair any leaks that have caused the bubbles, whether tubing, fitting, or component.</li> <li data-bbox="938 1220 1372 1524">4. Do high/low carryover checks (see Heading 1.4). Backgrounds should pass or be very close on the first blank. If they are high and then fall on subsequent cycles, there could be blood left over from the previous cycle.</li> </ol>

**Table 3.8 Background Problems (Continued)**

Situation	Probable Cause	Suggested Action
WBC, RBC and Plt exceed limits. Hgb may also be high in noted instances.	5. Electrical interference. This will usually affect only the counts, not Hgb.	5. Ensure that the bath shield is on. The plate that the baths are mounted to, including the bath shield, is not connected to the main instrument.  Ensure no electrical connection is made, including salt buildup that could connect the shield or plate to the main instrument chassis.  Ensure there are no fluid spills in and around the bath area.  Ensure that no electrical equipment, especially motorized equipment, is operating near the instrument. Check the power source. Check that no motorized piece of equipment is plugged into the same power circuit.
only wbc results exceed background specifications.	1. Contamination to a smaller degree than above.  2. Bubbles in bath. Since only WBC is affected, the source is either incorrect mixing bubbles to the WBC bath or air in the lytic reagent system.  3. Electrical interference. This generally affects WBC and/or Plt first, since they normally produce smaller count pulses than the RBC.	1. Redo startup. Proceed as above if problem persists.  2. Check the bath during count for excessive mixing bubbles. Check the lytic reagent (yellow tubing) system for leaks, air bubbles. The lytic reagent sensor is located in the line just after it enters the instrument; therefore it will not detect bubbles in the instrument, only incoming bubbles.  3. See above. Problem could also be with WBC bath/aperture assembly, connection to the Analyzer card, or the Analyzer card itself.



**Table 3.8 Background Problems (Continued)**

<b>Situation</b>	<b>Probable Cause</b>	<b>Suggested Action</b>
Only RBC results exceed background specifications.	<ol style="list-style-type: none"> <li>1. Excessive mixing bubbles.</li> <li>2. Air in sweepflow. This may also affect Plt backgrounds.</li> </ol>	<ol style="list-style-type: none"> <li>1. Check green stripe tubing to bottom of RBC bath for partial obstructions and replace the tubing, if necessary.</li> <li>2. Perform a sweepflow prime. Watch the tubing in the sweepflow spool for air bubbles. If the line does not prime, look for air leaks in the tubing from the reservoir to the sweepflow tubing.</li> </ol>
only Plt results exceed background specifications	<ol style="list-style-type: none"> <li>1. Plts are the smallest pulses measured. Any problem that affects all the other count parameters will affect Plts first. Depending how bad the problem is, only Plts may be affected. This includes contamination, bubbles, sweepflow problems, and electrical interference.</li> </ol>	<ol style="list-style-type: none"> <li>1. See above.</li> </ol>



**TROUBLESHOOTING**  
*TROUBLESHOOTING GUIDES*

**Table 3.9 Irregular Sample Results**

<b>Situation</b>	<b>Probable Cause</b>	<b>Suggested Action</b>
All counted parameters are consistently lower than normal. MCV is normal.	<ol style="list-style-type: none"> <li>Short sample.</li> <li>Poor bath drain.</li> <li>Diluted sample.</li> </ol>	<ol style="list-style-type: none"> <li>See aspiration problems in Table 3-7.</li> <li>Leaks or plugs are in drain path, LV14 or LV15 has a problem, plugged check valve is near LV13, waste pump peristaltic pump tubing has a problem.</li> <li>Check that probe wipe is working and not dripping into sample. See aspiration problems in Table 3-7.</li> </ol>
All counted parameters are consistently higher than normal. MCV is normal.	<ol style="list-style-type: none"> <li>Incomplete probe wipe.</li> <li>Insufficient diluent for dilution.</li> </ol>	<ol style="list-style-type: none"> <li>Check for signs of blood left on probe at end of cycle. Check for blood left at lower probe wipe fitting when probe has just retracted.</li> <li>Check for air in diluent path from syringe, to probe and to side fitting at bottom of bath. Check for diluent leaks at bottom of WBC bath.</li> </ol>
All counted parameters are consistently higher than normal.	<ol style="list-style-type: none"> <li>Contamination</li> <li>Electrical interference</li> </ol>	<ol style="list-style-type: none"> <li>See high backgrounds in Table 3-8.</li> <li>See high backgrounds in Table 3-8.</li> </ol>
WBC and Plt are too high or low, Hgb and RBC are opposite, too low or high.	Sample was not mixed adequately before aspiration.	Remix sample and cycle again.
Parameters generally erratic with no specific high/low trend.	Poor or no mix bubbles in bath.	Check green striped tubing at bottom of baths for leaks or plugs. Inspect or replace the check valves in these lines. LV3 and LV4 may have problems. They are at the other end of the green striped tubing.
Samples run in Predilute mode have erratic parameters.	Incorrect or contaminated predilute dilution.	Verify predilution. Make a dilution using larger volumes or use the <b>Verify Predilute</b> icon in the Diagnostics Function screen.

**Table 3.9 Irregular Sample Results (Continued)**

<b>Situation</b>	<b>Probable Cause</b>	<b>Suggested Action</b>
WBC results are higher than normal.	<ol style="list-style-type: none"> <li>1. Insufficient lytic reagent.</li> <li>2. Insufficient mix bubbles to WBC dilution.</li> <li>3. Electrical interference.</li> <li>4. Cracked aperture. This will generally cause WBC Aperture Alerts before the affect to results is noticeable.</li> </ol>	<ol style="list-style-type: none"> <li>1. Air bubbles or leak in lytic reagent system. Check reagent lines as above.</li> <li>2. Check for mixing bubbles after lytic reagent has been added. These bubbles enter lower right side port of WBC bath. Check the green stripe tubing, the check valve in this tubing, and LV4.</li> <li>3. See electrical interference and backgrounds in Table 3-8. Do a background and see if it passes.</li> <li>4. Replace WBC aperture bath assembly.</li> </ol>
WBC and Hgb results are higher than normal.	Insufficient lytic reagent in dilution. More severe case than above. Will get WBC voteouts or Aperture Alerts frequently.	Check for insufficient lytic reagent as above.
WBC results are lower than normal.	<ol style="list-style-type: none"> <li>1. Protein buildup on aperture.</li> <li>2. Problem with vacuum draw to aperture. This will cause an Aperture Alert before the results are noticeably low.</li> </ol>	<ol style="list-style-type: none"> <li>1. Perform several zap aperture functions from the Diluter Functions screen. If this is not sufficient, bleach the apertures and baths using the <b>Clean Baths</b> icon from the Diluter Functions screen (Heading 1.3).</li> <li>2. Check the red stripe tubing leaving the rear of the bath, going to LV17, and going from LV17 to the VIC. A plug in LV17 or in the fitting entering the VIC is also a possibility.</li> </ol>

**Table 3.9 Irregular Sample Results (Continued)**

Situation	Probable Cause	Suggested Action
Hgb results are erratic.	<ol style="list-style-type: none"> <li>1. Fluid in optical path outside of bath.</li> <li>2. Bubbles in blank rinses. Blanks are taken on the rinse that is in the bath before aspiration takes place and the rinse that occurs just after the WBC/Hgb dilution is drained. The latter rinse will be more suspect.</li> <li>3. Abnormal sample interfering with Hgb.</li> </ol>	<ol style="list-style-type: none"> <li>1. Check for fluid and salt deposits on outside of bath and Hgb components. Remove, clean and dry, if necessary. If there is fluid, find the source and repair if necessary.</li> <li>2. The diluent rinse comes from the diluent syringe. Correct any leaks and air in this system.</li> <li>3. Run several other samples to see if problem is unique to original sample.</li> </ol>
RBC, MCV and Plt are affected.	<ol style="list-style-type: none"> <li>1. Inadequate mixing or bubbles remaining during count.</li> <li>2. Sweepflow problem.</li> </ol>	<ol style="list-style-type: none"> <li>1. Check for mixing bubble problems or leaks in the diluent path from the syringe to the bath and probe. See above.</li> <li>2. Perform the Sweepflow function from the Diluter Functions screen (see Table 3-1). Ensure that fluid moves in the sweepflow system and that all bubbles have been removed.</li> </ol>
RBC, Plt incorrect	<ol style="list-style-type: none"> <li>1. Dilution problem.</li> <li>2. Aspiration problem.</li> <li>3. Aperture sampling problem.</li> </ol>	<ol style="list-style-type: none"> <li>1. Air in diluent, possible leak. See above.</li> <li>2. Air in aspiration path after sample delivered to WBC bath, causing aspiration problems for RBC aspiration. RBC dilution aspirates fluid from WBC bath after initial delivery and mix. If level in bath is too low, or probe barely reaches level, results are low.</li> <li>3. Partial plug or leak in aperture area, red tube from rear of bath to Vacuum Isolator Chamber (VIC), LV16, or tubing port on VIC. A severe blockage or leak could cause an Aperture Alert.</li> </ol>

# B

## TROUBLESHOOTING TROUBLESHOOTING GUIDES

**Table 3.9 Irregular Sample Results (Continued)**

Situation	Probable Cause	Suggested Action
MCV only incorrect.	<ol style="list-style-type: none"> <li>1. Protein buildup on aperture, causing elevated MCV. If this problem gets worse, Plts and RBCs are affected. A high frequency of RBC Aperture Alerts occurs.</li> <li>2. Cracked aperture resulting in low MCV. If the crack is bad, RBC Aperture Alerts will occur. Also the RBC and Plt counts will increase.</li> </ol>	<ol style="list-style-type: none"> <li>1. Perform the <b>Clean Baths</b> function from the Diluter Functions screen (see Heading 1.3, Clean the Baths).</li> <li>2. If this is the problem, you must replace the RBC aperture bath. Call your Coulter Representative.</li> </ol>
Plt only incorrect	<ol style="list-style-type: none"> <li>1. Electrical interference. Since Plts produce the smallest pulses analyzed by the system, low level electrical interference affects Plts only.</li> <li>2. Contamination by small particles could also affect Plts only. This is unlikely, since contamination usually involves a wide size range of particles.</li> <li>3. Fluid in sweepflow, but sweepflow is not moving. This could be a plug or an air lock that low vacuum cannot break.</li> </ol>	<ol style="list-style-type: none"> <li>1. See electrical interference under background problems, Table 3-8.</li> <li>2. Change diluent. If the instrument is badly contaminated, especially with biological growth, run the Prepare to Ship procedure from the Diagnostic Functions screen.</li> <li>3. Perform the Sweepflow prime from the Diluter Functions screen. This function primes the sweepflow with high vacuum. Make sure that fluid is moving. If not, a plug or a leak in the sweepflow check valve could be the problem.</li> </ol>

**Table 3.9 Irregular Sample Results (Continued)**

Situation	Probable Cause	Suggested Action
Whole blood results similar to pattern below: WBC $2.0 \times 10^3$ cells/ $\mu$ L RBC +++++ $\times 10^6$ cells/ $\mu$ L Hgb +++++ g/dL Hct +++++ % MCV +++++ fL MCH 25 pg MCHC 10 g/dL Pit 0 $\times 10^3$ cells/ $\mu$ L	Whole blood was analyzed in the A <sup>C</sup> •T Tron mode.	Select <b>Whole Blood</b> mode and rerun the patient sample.
Whole blood results similar to pattern below: WBC - - - - - $\times 10^3$ cells/ $\mu$ L RBC +++++ $\times 10^6$ cells/ $\mu$ L Hgb +++++ g/dL Hct +++++ % MCV +++++ fL MCH 40 pg MCHC 15 g/dL Pit 0 $\times 10^3$ cells/ $\mu$ L	Undiluted whole blood was analyzed in the <b>Predilute</b> mode.	Select <b>Whole Blood</b> mode and rerun the patient sample.

# B

## **TROUBLESHOOTING** *TROUBLESHOOTING GUIDES*



**Table 3.10** A<sup>C</sup>•T Tron<sup>†</sup> Cell Control Results

Situation	Probable Cause	Suggested Action
All results are within the assay ranges listed in the TABLE OF EXPECTED RESULTS.	The A <sup>C</sup> •T System is operating properly.	Analyze patient samples.
Upon initial use, the Hgb results are low outside of the assay ranges listed in the TABLE OF EXPECTED RESULTS.	Possible damage due to prolonged exposure to high temperature.	<ol style="list-style-type: none"> <li>1. Thoroughly mix a new control vial from a different package or shipment.</li> <li>2. Rerun the control.</li> <li>3. If the problem persists, call your Coulter Representative.</li> </ol>
Upon initial use, the WBC, RBC and Plt results are low outside of the assay range listed in the TABLE OF EXPECTED RESULTS.	<ul style="list-style-type: none"> <li>■ Improper handling of the control.</li> <li>■ The cap was removed before mixing the control.</li> <li>■ Insufficient mixing.</li> <li>■ Control not stored horizontally.</li> </ul>	<ol style="list-style-type: none"> <li>1. Thoroughly mix a new control vial before opening.</li> <li>2. Rerun control.</li> <li>3. If problem persists, see Table 3-9, Irregular Sample Results, for possible instrument problem.</li> </ol>
Upon continued use, the WBC, RBC and Plt results are low outside of the assay range listed in the TABLE OF EXPECTED RESULTS.	<ul style="list-style-type: none"> <li>■ Improper handling of the control.</li> <li>■ The cap was removed before mixing the control.</li> <li>■ Insufficient mixing.</li> <li>■ Control not stored horizontally.</li> </ul>	<ol style="list-style-type: none"> <li>1. Thoroughly mix a new control vial before opening.</li> <li>2. Rerun control.</li> <li>3. If problem persists, see Table 3-9, Irregular Sample Results, for possible instrument problem.</li> </ol>
WBC, RBC and Plt results are high after 31 aspirations.	<ul style="list-style-type: none"> <li>■ More than 31 aspirations.</li> <li>■ Insufficient volume of supernatant to mix the cells.</li> </ul>	<ol style="list-style-type: none"> <li>1. Thoroughly mix a new control vial.</li> <li>2. Rerun control.</li> <li>3. If problem persists, see Table 3-9, Irregular Sample Results, for possible instrument problem.</li> </ol>

**Table 3.10 A<sup>C</sup>•T Tron<sup>z</sup> Cell Control Results (Continued)**

Situation	Probable Cause	Suggested Action
Sudden upward shift in Hgb recoveries of approximately 1 gram. WBC results may also shift upward.	<ul style="list-style-type: none"> <li>■ Not a control problem.</li> <li>■ Possible instrument problem.</li> </ul>	See Table 3-9, Irregular Sample Results, for possible instrument problem.
WBC, RBC, Hgb and Plt results are all above the assay range.	<ul style="list-style-type: none"> <li>■ Not a control problem.</li> <li>■ Possible instrument problem.</li> </ul>	See Table 3-9, Irregular Sample Results, for possible instrument problem
WBC, RBC and Plt results trend upward.	<ul style="list-style-type: none"> <li>■ Increase in laboratory temperature.</li> <li>■ More than 31 aspirations.</li> </ul>	<ol style="list-style-type: none"> <li>1. Use TABLE OF EXPECTED RESULTS for your laboratory operating temperature.</li> <li>2. Thoroughly mix a new control vial.</li> <li>3. Rerun control. If problem persists, see Table 3-9, Irregular Sample Results, for possible instrument problem.</li> </ol>
Increase in WBC, RBC, Plt without a significant change in Hgb.	Increase in laboratory temperature.	Use the corresponding TABLE OF EXPECTED RESULTS for your laboratory operating temperature.
An upward trend of 1 to 2 FI in MCB over the 3-month shelf life of the product.	MCV may show trending through the product shelf life. This is inherent to the control and is not an indication of instability. 95% of the control results should remain within the assay ranges found in the TABLE OF EXPECTED RESULTS.	No action, normal characteristic of aging RBCs.

**Table 3.10** A<sup>C</sup>•T Tron<sup>‡</sup> Cell Control Results (Continued)

Situation	Probable Cause	Suggested Action
Controls results similar to pattern below: WBC 36 x 10 <sup>3</sup> cells/ $\mu$ L RBC 0.04 x 10 <sup>6</sup> cells/ $\mu$ L Hgb 2.0 g/dL Hct 0.3 % MCV 66.9 fL MCH +++++ pg MCHC +++++ g/dL Plt - - - - - x 10 <sup>3</sup> cells/ $\mu$ L	A <sup>C</sup> •T Tron cell control was analyzed in the <b>Whole Blood</b> mode.	Select the A <sup>C</sup> •T <b>Tron</b> mode and rerun the control.
Controls results similar to pattern below: WBC +++++ x 10 <sup>3</sup> cells/ $\mu$ L RBC 3.2 x 10 <sup>6</sup> cells/ $\mu$ L Hgb +++++ g/dL Hct 20 % MCV 64 fL MCH +++++ pg MCHC +++++ g/dL Plt 195 x 10 <sup>3</sup> cells/ $\mu$ L	A <sup>C</sup> •T Tron cell control was analyzed in the <b>Predilute</b> mode.	Select the A <sup>C</sup> •T <b>Tron</b> mode and rerun the control.



**TROUBLESHOOTING**  
*TROUBLESHOOTING GUIDES*

## Symbols

\* 3-13  
 \*\*\*\*\* 3-10  
 + 3-10  
 ++++++ 3-9  
 ..... 3-12

## A

Ac•T Reagent Management Card 3-16  
 Ac•T Tron  
     results 3-33  
 Ac•T Tron‡  
     results 3-35  
 AcT Pak  
     replace 2-1  
 AcT Rinse Shutdown Diluent  
     replacing container 2-3  
 AcT Tainer  
     Data Management card 2-4  
     replace 2-4  
 action limit 3-12  
 air 3-24, 3-26, 3-27, 3-29, 3-30, 3-31  
 aperture 3-26, 3-31  
     cracked 3-30, 3-32  
     zap 3-3  
 Aperture Alert 3-10, 3-11, 3-12  
 aperture alerts 3-30  
 apertures  
     zap 3-7, 3-10  
 aspiration 3-23  
 aspiration path 3-31  
 aspiration problems 3-23, 3-29  
     air in aspiration path 3-23  
     bubbles 3-24  
     bubbles in aspirator tubing 3-24

incomplete aspiration 3-23  
 sample drips from probe after aspiration  
     3-23  
 tubing 3-23

asterisks 3-10

## B

background problems 3-25  
     blood 3-25  
     bubbles 3-25, 3-27  
     contamination 3-25, 3-27  
     diluent 3-25  
     electrical interference 3-26  
     Hgb 3-25  
     limits 3-25  
     only Plt results exceed background  
         specifications 3-27  
     only RBC results exceed background  
         specifications 3-27  
     only wbc results exceed background  
         specifications 3-26  
     Plt 3-25, 3-26  
     RBC 3-25, 3-26, 3-27  
     sweepflow 3-27  
     WBC 3-25, 3-26  
     WBC, RBC, and Plt exceed limits 3-25,  
         3-26  
 barrels 3-18  
 baths 3-8, 3-25, 3-26, 3-27, 3-31, 3-32  
     diluter screen, cleaning functions 3-2  
     sample result problems 3-31  
     sample results problems 3-31  
     WBC 3-15  
 biohazardous material 2-9, 2-26  
 blood 3-25, 3-29

## INDEX

- bubbles 3-19, 3-24, 3-27, 3-29, 3-30, 3-31
- buildup 3-19, 3-26
- C
- calibration 1-2
- card 3-26
  - analyzer 3-19
  - reagent management 3-16
  - software 3-17
- carryover 3-25
- chamber 3-31
- check valves 1-2
  - replace 2-13
- Clean Baths 3-32
- clean the baths 1-2
- cleaner 2-3, 3-17
- clots 3-10
- contamination 3-25, 3-26, 3-27, 3-29, 3-32
- continue icon 3-21
- COULTER S-CAL® calibrator 1-7
- count periods 3-7
- counts
  - high 3-29
  - low 3-29
- D
- dashes (-----)
  - flags description 3-8
- dashes (-----), flags description, 3-7
- debris 3-19
- deposits 3-31
- diagnostic functions xiv, 3-4
- Diagnostic Functions screen 3-32
- Diagnostics Function screen 3-29
- diluent 3-4, 3-24, 3-29, 3-31, 3-32
  - contaminated 3-25
- diluent empty 3-16
- Diluent Empty, warning message descrip-
- tion 3-16
- diluent filters 1-3, 2-7
- diluent leak 3-15
- Diluent Level Error During Power Up
  - fatal error, description 3-19
- diluent prime 3-2
- diluent reservoir 3-19
- diluter functions xiii, 3-2, 3-30, 3-31, 3-32
- Diluter Functions screen 3-32
- dilution 3-9, 3-29
- dispense 3-4
- dots 3-12
- drain
  - baths 3-2
  - VIC 3-2
- drain path 3-29
- DVM Error 3-17
- E
- electrical interference 3-26, 3-29, 3-30, 3-32
- electronic failure 3-15
- electronics pulse test 3-5
- equilibration 3-12
- error messages, fatal 3-17
- error messages, flags 3-7
- error messages, warning 3-15
- errors
  - fatal 3-17
- F
- fatal errors 3-17
- fatal errors, description 3-17
- fibrin strands 3-10
- filters 1-3, 3-16
  - replace 2-7, 2-8
- flags 3-7, 3-9, 3-11, 3-12
- flags, description 3-7

- fluid barrier filter 2-7
- fluid drips 3-23
- FS3 3-17
- fuses 1-2
  - replace 2-16
- H
- H 3-12
- Hct 3-14
- Hgb 3-12, 3-14, 3-25, 3-29, 3-30, 3-31
- Hgb lamp 3-15
- high counts 3-29
- I
- I2 C Communication Failure 3-19
- irregular sample results
  - all parameters 3-29
  - aspiration problem 3-31
  - aspiration problems 3-29
  - contamination 3-29, 3-32
  - diagnostic functions 3-32
  - diluter functions 3-31, 3-32
  - dilution problems 3-31
  - electrical interference 3-29, 3-30, 3-32
  - Hgb 3-31
  - insufficient lytic reagent 3-30
  - insufficient mix bubbles 3-30
  - MCV 3-31, 3-32
  - Plt 3-31, 3-32
  - predilute 3-29
  - RBC 3-31
  - sweepflow 3-32
  - vacuum draw 3-30
- K
- kinks 3-23
- L
- L 3-12
- laboratory quality control program 1-7
- leak 3-15, 3-19, 3-23, 3-31
- leaks 1-3, 3-23, 3-26, 3-29, 3-31
- limits 3-25, 3-26
- linear range 3-14
- linearity 3-9
- low counts 3-29
- LV11
  - aspiration problem 3-23, 3-24
- LV12
  - aspiration problem 3-23, 3-24
- LV13
  - sample results problem 3-29
- LV14
  - sample results problem 3-29
- LV15
  - sample results problem 3-29
- LV16 3-31
- LV17 3-30
  - sample results problem 3-30
- LV3
  - sample results problem 3-29
- LV4
  - sample results problem 3-29, 3-30
- LV6 3-32
- lyse prime 3-2
- lytic reagent 3-30
- lytic reagent empty 3-17
- M
- main screen xi
- maintenance procedures 1-1
  - general 1-1
- manuals
  - about this manual viii
  - conventions viii
  - how to use your documentation vii
  - screen icons xi

## INDEX

- symbols ix
- MCH 3-14
- MCV 3-9, 3-14, 3-31, 3-32
- messages
  - fatal error 3-17
  - warning 3-15
- mixing 3-31
  - sample 3-29
- mixing bubbles 3-2
- motor 3-18, 3-19
- O
- operating range 3-14
- out of limits 3-14
- P
- PCMCIA Error 3-17
- peristaltic pump 3-17
- peristaltic pump tubing 1-3
  - replace 2-9
- pickup tubes
  - AcT Pak 2-2
  - cleaner 2-3
  - reagent 2-2
- pistons 3-18
- Plt 3-9, 3-10, 3-11, 3-12, 3-25, 3-26, 3-27, 3-29, 3-31
- Plt only incorrect 3-32
- plugged filter 3-19
- plugs 3-19, 3-23, 3-29, 3-31
- plus 3-10
- pluses 3-9
- PM1 3-17
- power problems 3-21
  - cord 3-21
  - defective power switch 3-21
  - instrument malfunctions 3-21
  - voltage 3-21
- predilute 3-4
- Predilute mode 3-29
- prepare to ship 2-29, 3-5, 3-25, 3-32
- preventive maintenance procedures 1-1
- prime 2-1, 2-4, 3-32
  - diluent 3-2, 3-16
  - lyse 3-2
  - sweepflow 3-2
  - wet 3-2
- printer 3-15
- probe 3-23
- probe position 3-18
- probe wipe 1-3, 3-23, 3-29
  - replace 2-26
- pump tubing 1-3
- R
- range
  - linear 3-14
  - operating 3-14
- ratio 3-14
- RBC 3-10, 3-11, 3-12, 3-14, 3-25, 3-26, 3-27, 3-29, 3-31
- RBC bath 3-32
- reagent 3-16
  - lytic 3-30
  - open new container 2-4
  - prime 2-4
  - replace AcT PAK 2-1
- reagents 1-4
  - prime 2-1
- reagents, replacement
  - AcT Rinse 2-3
  - AcT Tainer 2-4
- reference range 3-12
- replace
  - check valves 2-13



- replace filters 2-8
- replacement
  - AcT Rinse Shutdown Diluent 2-3
  - check valve 1-2
  - filters 2-7
  - fluid filters 1-3
  - fuses 1-2, 2-16
  - peristaltic pump tubing 1-3, 2-9
  - probe wipe 1-3, 2-26
  - reagents 1-4
  - syringe piston and seal 1-3, 2-22
  - tubing 1-3, 2-15
  - vacuum isolator chamber 1-3, 2-17
  - waste container 2-6
- replacement procedures
  - AcT PAK 2-1
  - AcT Tainer 2-4
- reservoir 3-24
- results
  - sample 3-29
- S
- sample 3-12
  - details 3-5
  - transmission 3-15
- sample ID xv
- sample mixing 3-29
- sample results xv, 3-29
  - irregular. *See* irregular sample results
- screen
  - diagnostic functions xiv, 3-4
  - diagnostics 3-29
  - diluter functions xiii, 3-2, 3-30
  - main screen xi
  - sample ID xv
  - sample results xv
  - setup xii
- sensor 3-18
  - waste 2-6
- setup xii, 3-16
- ship 3-5
- Shutdown 1-2
- software card 3-17
- solenoid 3-23
- solenoids 3-4
- startup 1-2, 3-15, 3-25, 3-26
- Steps Missing 3-19
- sweepflow 3-2, 3-27, 3-31, 3-32
- sweepflow prime 3-27
- symbol
  - waste ix
- symbols
  - 3-7, 3-8
- syringe 3-18, 3-19, 3-23, 3-24, 3-29, 3-31
- syringe module 3-23
- syringe piston and seal 1-3
  - replace 2-22
- syringe position 3-18
- T
- test
  - electronic pulse 3-5
  - motors 3-5
- Time Keeper Failure 3-16
- transmission
  - incomplete 3-15
- troubleshooting tools 3-1
- tubing 1-3, 2-18, 3-17, 3-23, 3-29
  - replace 2-15
- U
- Unexpected Software Condition 3-17
- V
- vacuum 3-23, 3-30
- Vacuum Isolator Chamber 1-3, 2-18, 3-15,

## INDEX

3-23, 3-30, 3-31  
    replace 2-17  
    sample results problem 3-30  
valve error 3-18  
verify predilute 3-4, 3-29  
VIC 3-30, 3-31  
Voltage Failure 3-15  
voltage fuses 3-21  
voltage screen 3-15  
voteout 3-7, 3-8  
W  
warning messages 3-15  
waste  
    full 3-16  
    sensor 2-6  
waste container  
    replace 2-6  
waste full 3-16  
waste symbol ix  
WBC 3-9, 3-10, 3-11, 3-12, 3-25, 3-26, 3-29, 3-30  
WBC bath 3-15  
wet prime 3-2  
Y  
Y-fitting 3-23  
Z  
zap apertures 3-3, 3-7, 3-10, 3-30



# COULTER® A<sup>C</sup>•T SERIES DOCUMENTATION

- **Reference**  
PN 4237288
    - Use and Function
    - Installation
    - Operation Principles
    - Specifications/Characteristics
    - Precautions and Hazards
  - **Operator's Guide**  
PN 4237287
    - Using this Document
    - Screen Symbols
    - Warnings/Instructions
    - Run Samples - Whole Blood Mode
    - Run Samples - Predilute Mode
  - **Getting Started**  
PN 4237289
    - Installing the A<sup>C</sup>•T
    - Learning about the A<sup>C</sup>•T
    - Using the Instrument
    - Index
  - **Special Procedures and Troubleshooting**  
PN 4237314
    - Preventive Maintenance Procedures
    - Replace/Adjust Procedures
    - Troubleshooting
    - Index
  - **Host Transmission Specification**  
PN 4237283
    - Introduction
    - High-Level Record Field Definitions
    - Low-Level Protocol Description
    - Appendices
- Appendix  
References  
Glossary  
Index
- Startup  
Run Controls  
Shutdown  
Review Results



COULTER, 4C, "CC" logo and S-CAL are trademarks of Coulter International Corp.  
Copyright © Coulter Corporation 1996, 1997  
All Rights Reserved  
Printed on Recycled Paper



**COULTER**  
SCIENCE SERVING HUMANITY  
COULTER CORPORATION  
Miami, Florida 33196